

TACKLING THE CHALLENGES OF FULL PIT LATRINES

Volume 3: The development of pit emptying technologies

Report to the
Water Research Commission

by

David Still¹ & Mark O’Riordan²

¹Partners in Development

²Engineers without Borders, UK



WRC Report No. 1745/3/12
ISBN 978-1-4312-0293-5
Set No. 978-1-4312-0294-2

July 2012

Obtainable from:

Water Research Commission
Private Bag X03
Gezina, 0031

orders@wrc.org.za or download from www.wrc.org.za

The publication of this report emanates from a project entitled: *Understanding the sludge accumulation in VIPs, UD's and other on-site sanitation systems, and strategies to manage desludging in the future when pits are full* (WRC Project No. K5/1745)

This study has been co-funded by IRISH AID.

DISCLAIMER

This report has been reviewed by the Water Research Commission (WRC) and approved for publication. Approval does not signify that the contents necessarily reflect the views and policies of the WRC, nor does mention of trade names or commercial products constitute endorsement or recommendation for use.

EXECUTIVE SUMMARY

Over two million VIPs and other on-site sanitation systems have been built by the South African government since 1994. A backlog of households lacking basic sanitation still remains, however, and many municipalities are still focussed on meeting this need and have not yet turned their attention to the question of what they will do when the systems they have already built reach capacity. This is expected to happen in the next few years, resulting in an overwhelming demand for pits to be emptied. Without funds, policies, tools or procedures in place to manage the emptying of pits and disposal of sludge when this happens, many WSAs around the country may soon be facing a crisis.

A survey of municipalities across the country indicates that there is a general assumption on the part of sanitation managers that they will be able to service VIP pits with a vacuum tanker as they do septic tanks. However, the dry consistency of VIP sludge and the high rubbish content that is found in many pits can present obstacles to vacuum removal. In addition, there are many households across South Africa with access only by footpaths which cannot be accessed by a vacuum tanker.

eThekwini Municipality, which has the largest pit emptying programme in South Africa, has found manual pit emptying with long-handled tools to be the most effective method to service its 35 000 pit latrines. Manual emptying is difficult, time consuming and, if adequate protective equipment and safety practices are not used, can endanger the health of workers. Clearly, a range of technologies suited to the varying conditions encountered in pit emptying is needed.

This report presents the design, development and testing of a number of prototypes of portable pit emptying technologies that were developed as part of Water Research Commission research project K5/1745. It is preceded by two other reports in the *Tackling the challenges of full pits* series:

Volume 1: Understanding sludge accumulation in VIPs and strategies for emptying full pits.

Volume 2: How fast do pit toilets fill up? A scientific understanding of sludge build up and accumulation in pit latrines

The designs which have been explored to date have been the pit screw auger, which uses a motorised soil auger to lift sludge from a pit, the Nano Vac and e Vac, which use piston pumps and vane pumps to suck relatively wet sludge from pits. In addition, a pressure vessel has been developed which can be used for collecting sludge or for pumping water or air into a pit to aid removal.

Being portable by two people these technologies do overcome the issue of access and have proven viable when trialled on pig slurry. The eVac has in addition been used successfully to empty wettish pit latrines in the field, which it does with little difficulty. Being the most robust and the most compact of the devices, the eVac appears to have the most potential on pit latrines in the field, and should be the focus for further research and development work.

ACKNOWLEDGEMENTS

This project was made possible with funding from Irish Aid. Supplementary development work on the eVac was carried out with funding from Water for People, under the guidance of Steven Sugden and Manus Coffey. The project team thanks the staff of eThekweni Metro Municipality for their contribution to this research. The project team is also grateful to the following Engineers Without Borders volunteers from Britain who have contributed their time and expertise to the development of small mechanised Pit Emptying Technologies (PETs) for the South African context:

Mark O’Riordan
Joanna Reed
Simon McKean
India Elsdon
Rachel Pringle
Angus McBride

The project team thanks the councillors and home owners who have facilitated field trials.

The project team is grateful to the reference group which provided invaluable guidance and insight during the course of the project:

Jay Bhagwan	Water Research Commission (Chairman)
John Harrison	eThekweni Water and Sanitation
Speedy Moodliar	eThekweni Water and Sanitation
Cyprian Mazubane	Department of Human Settlements
Iris Lebepe	Department of Human Settlements
Frank Kirwan	Irish Aid
John Annandale	University of Pretoria
Eyob Tesfamariam	University of Pretoria
Richard Holden	TCTA
Ian Pearson	WATSUP Development
Gordon Borain	Umgeni Water
John Hughes	University of KwaZulu-Natal

TABLE OF CONTENTS

EXECUTIVE SUMMARY	III
ACKNOWLEDGEMENTS	IV
TABLE OF CONTENTS	V
LIST OF FIGURES	VI
1 INTRODUCTION	1
2 TOOL TO AID MANUAL EXHAUSTION	6
3 THE GOBBLER	8
3.1 Design development.....	8
3.2 Evaluation.....	10
4 PIT SCREW AUGER	11
4.1 Development of manually powered prototype.....	11
4.2 Development of mechanised prototype	12
4.2.1 Power.....	12
4.2.2 Housing	13
4.2.3 Intake	13
4.2.4 Discharge	14
4.2.5 Extension	16
4.2.6 Support	17
4.3 Testing.....	18
4.3.1 Testing on pit latrine sludge	19
4.4 Evaluation.....	19
4.5 Recommendations for further development	20
5 INVESTIGATING VACUUM TECHNOLOGIES	22
5.1 Pros and cons of vacuum systems.....	22
5.2 Vacuum principles	22
5.3 Overcoming variability in sludge density	25
5.4 Testing the Vacutug	27
6 THE NANO VAC	31
6.1 Design and development.....	31
6.1.1 Pump.....	35
6.1.2 Vacuum tank	36
6.2 Evaluation.....	36
6.3 Recommendations for further development	38
7 THE EVAC	40
7.1 Prototype development.....	40
7.1.1 Motor.....	41
7.1.2 Pump.....	41
7.1.3 Pressure vessel.....	42
7.1.4 Hoses and fittings	45
7.1.5 Air and water lance.....	46
7.2 Testing.....	46
7.3 Evaluation.....	48
7.4 Recommendations.....	49
8 CONCLUSIONS	51
REFERENCES	52
APPENDIX A: SPECIFICATIONS FOR PIT SCREW AUGER	53
APPENDIX B: SPECIFICATIONS FOR EVAC	55

LIST OF FIGURES

Figure 1.1 Some pits are difficult for workers or equipment to access.....	1
Figure 1.2 Access to pits in densely settled communities presents an obstacle to municipal vacuum tankers....	1
Figure 1.3 Tools used for manual pit emptying at eThekweni.....	2
Figure 1.4 Bangalore Screwer (left) and Nibbler (center and right)	3
Figure 1.5 Left: The MAPET (WASTE, 2009). Right: The Gulper (Steven Sugden).....	3
Figure 1.6 Left: The Micravac (left) (Manus Coffey). Right: The Dung Beetle (J.Hvidtved Larsen)	4
Figure 2.1 Open and closed positions of sketch model of enclosed spade	6
Figure 2.2 Actuation of enclosed spade from open to closed positions.....	6
Figure 3.1 Initial design concept for the Gobbler	8
Figure 3.2. First Gobbler prototype	9
Figure 3.3 Second prototype of Gobbler with single chain and sprung scraper.....	9
Figure 3.4 Pros and cons of the Gobbler design	10
Figure 4.1 Prototype of manual pit screw auger	11
Figure 4.2 Offset gear box with chain and sprockets	12
Figure 4.3 Hinged sleeve enables blockages to be more easily removed	13
Figure 4.4 Blades added to auger point.....	13
Figure 4.5 Swept elbow termination compared with 45 degree tee termination (left), 45 degree tee with lay flat hose (centre) and 45 degree plate termination (right).....	15
Figure 4.6 The addition of a short section of reversed auger at the top of the column makes it possible for the sludge to be ejected through the side opening.	15
Figure 4.7 Flexible pipe on outlet	16
Figure 4.8 Adding an extension to the auger.....	17
Figure 4.9. Using a tripod to support the Pit Sludge Auger while it is manoeuvred around the sludge	17
Figure 4.10 Pit screw auger during testing	18
Figure 4.11 Using the auger to empty a VIP pit (left). The amount of rubbish which the pit contained (right) made it impossible for the auger to remove sludge.	19
Figure 4.12 Advantages and disadvantages of the Pit Screw Auger.....	19
Figure 4.13 A total length of 2.8 m is optimal for the auger	20
Figure 4.14 The fixed length of the auger presents a problem where a pit must be accessed through the pedestal (left) rather than through an access hatch (right).....	21
Figure 4.15 Concept for a stationary auger operated from outside of the structure	21
Figure 5.1 This vacuum tanker will need more than six times the vacuum power at the bottom of the pit than at the top (Manus Coffey).....	23
Figure 5.2 Air can enter the hose and break the flow when vacuuming dry sludge (Manus Coffey).....	24
Figure 5.3 High vacuum/low airflow approach (Manus Coffey).....	24
Figure 5.4 Air drag system with a low vacuum/high airflow approach (Manus Coffey)	24
Figure 5.5 Air bleed system (Manus Coffey).....	25
Figure 5.6 Plug and drag system (Manus Coffey)	25
Figure 5.7. Effect of fluidisation on the shear characteristics of synthetic sludges (Radford).....	26
Figure 5.8 Water added to the sludge from above cannot adequately fluidize denser sludge at the bottom of the pit (left); UN-HABITAT proposed pre-cast concrete pit design with integrated suction hose may overcome this problem (right) (Manus Coffey)	27
Figure 5.9 The UN-HABITAT Vacutug (UN-HABITAT)	28
Figure 5.10 The size of the Vacutug compared to 1 ton bakkie (left) and the Vacutug unable to power itself over a small earth ridge (right).	28
Figure 5.11 Rubbish being removed from a pit with a rake (left). Using the Vacutug hose to mix water with sludge inside the tank (right).	29
Figure 5.12 Analysis of time taken to empty 1 cubic metre low flush soak pits using Vacutug	30
Figure 6.1 The original NanoVac concept. The red container would be alternately filled and emptied.....	31
Figure 6.2 First NanoVac prototype test rig.....	32

Figure 6.3 Upper valve moved from close to piston (left) to closer to the body of the machine (right)	33
Figure 6.4 Configuration of pipes changed so that lower pipes are yellow and upper pipes are blue.	34
Figure 6.5 Colour coding and labelling to aid correct operation	34
Figure 6.6 High bend in blow hose to prevent back flow of sludge.....	35
Figure 6.7 Testing the capacity of the Nano Vac to pump vertically	35
Figure 6.8 Various containers trialed as vacuum tanks: steel drum (left); Hippo Roller (centre) and gas canister (right)	36
Figure 6.9 Current Nano Vac prototype	37
Figure 6.10 Advantages and disadvantages of NanoVac in comparison to other pit emptying technologies	37
Figure 6.11 Simpler design option suitable for entrepreneurs (purple) and more complex design options suitable for municipality (orange).....	38
Figure 6.12 Sketch of Nano Vac with handles	39
Figure 7.1 The eVac	40
Figure 7.2 The components of the vane pump (the stator on the left, and rotor with removable vanes on the right).....	41
Figure 7.3 Moisture trap.....	42
Figure 7.4 A custom made 180 litre fibreglass tank which imploded under vacuum pressure.....	42
Figure 7.5 A pressure relief valve based on a design drafted by Manus Coffey (left); a standard pressure relief valve (right)	43
Figure 7.6 7 mm thick vessel imploded under vacuum (left) and 14 mm thick vessel currently in use with carrying straps (right).....	43
Figure 7.7 The sludge hose collapsed near the point of connection during testing (left); the “suck only” lid with steel elbow for connection to sludge hose (right)	44
Figure 7.8 The “suck and blow” vessel	45
Figure 7.9 Air/water lance	46
Figure 7.10 eVac emptying a pit using multiple pressure vessels with carrying handles	47
Figure 7.11 Emptying a pit with the eVac.....	48

1 INTRODUCTION

An on-site sanitation system requires a pit to collect accumulating sludge. The pit eventually reaches capacity. When it does, the alternatives are either to empty the pit and continue using it or to dig a new pit and move the top structure. If the sludge is to be removed, a number of issues must be considered. How accessible is the site and the pit for equipment and vehicles? What equipment will be able to effectively remove the sludge and how much will it cost (considering operator costs, capital and operations costs of equipment and filling/emptying frequency of pits)? How will workers and householders be protected from exposure to pathogens during pit emptying? How will the sludge be transported and how will it be used or disposed of?

The technology most commonly used for pit emptying by municipal sanitation departments and local entrepreneurs is the vacuum tanker. Often fleets of these machines will service large areas, extracting waste and carting it to treatment sites. Vacuum tankers are characterised by high capital and maintenance costs. In less industrialised countries long delays in repairs are very common and the cannibalising of broken down vehicles to obtain usable spares may be a regular practice. The typical result is a chronic shortage of tankers.

Vacuum tankers are an effective choice of technology where septic tanks and pit latrines are easily accessible and waste is fairly liquid and not mixed with solid waste. However, this is rarely the case in South Africa. Pits typically contain domestic refuse which can quickly block the vacuum hoses, making the job time consuming and messy. In unplanned areas, tanker trucks often cannot reach the households which need to be serviced because roads are poor and paths are too narrow. The VIPs themselves may have been designed without consideration for emptying and gaining access to the pit may be laborious. For these reasons, service providers sometimes limit servicing with a vacuum tanker to planned areas of town.



Figure 1.1 Some pits are difficult for workers or equipment to access



Figure 1.2 Access to pits in densely settled communities presents an obstacle to municipal vacuum tankers

A number of alternative technologies have been developed to address the challenges of pit emptying. Some of these rely only on manual power with the aid of hand tools, some are semi-mechanised (using manual power transferred through a mechanism) and others are fully mechanized systems which employ power from an engine or motor.

The most basic approach to removing sludge from a pit is to empty it manually with the use of hand tools. One of the many disadvantages of emptying pits manually is the length of time required to empty each pit. Despite the difficulties involved in manual pit emptying, it does have some advantages. It is a method which is very robust. Since it requires many workers, if one is ill work can still continue. In contrast, if a machine is used for emptying and it runs out of fuel or breaks, work grinds to a halt. In addition, manual emptying relies on local labour. This means that funding is spent in the community rather than tied up in expensive machinery and maintenance costs, also making it more feasible for small businesses. This brings additional benefits to the community beyond the emptying of latrines. The benefits however must be balanced against health risks and social acceptance. If the consistency of the sludge is wet, manual emptying may not be a viable option.

Figure 1.3 below shows the hand tools developed by the eThekweni Metropolitan Municipality (Durban, South Africa) for its pit emptying programme. The long handled shovel/scoop (centre and right) was found to be too heavy and was not much used in the field.



Figure 1.3 Tools used for manual pit emptying at eThekweni

Semi-mechanised technologies which have been tried to remove drier sludge include the Bangalore Screwer, an Indian-designed device which is based on the principle of using an auger screw to lift sludge from the pit, and the Nibbler, a device designed by Steve Sugden which uses scoops on a chain to lift waste. Both are operated with a hand crank. Neither have been taken beyond the early prototype stage. These two devices are shown in Figure 1.4.



Figure 1.4 Bangalore Screwer (left) and Nibbler (center and right)

In countries where water is used for anal cleansing instead of toilet paper, newspaper or other solid materials, the sludge will be wetter and more conducive to removal by vacuum. Disposal of greywater in the pit or conditions where the water table intersects with the pit will also result in wetter sludge. The success of mechanisms using suction to remove sludge will depend also on the density, viscosity and thixotropy¹ of the sludge as well as the total pumping head. Manually powered vacuum technologies include the MAPET, developed by WASTE and the Gulper, developed by Steven Sugden.



Figure 1.5 Left: The MAPET (WASTE, 2009). Right: The Gulper (Steven Sugden)

¹ **Thixotropy** is the property of certain gels or fluids that are thick (viscous) under normal conditions, but flow (become thin, less viscous) over time when shaken, agitated, or otherwise stressed (Wikipedia)

Fully mechanised vacuum technologies have also been developed for emptying pits in areas where vacuum tankers may not be suitable. These include the Micravac, developed by Manus Coffey, and the Dung Beetle, developed by the Dutch company, J.Hvidtved Larsen, which uses a two wheel tractor based drive, with the driver sitting on the tank and steering using the long handles on the machine. The Vacutug, developed by UN-HABITAT, was tested on low flush pits in South Africa as part of this project and is discussed in detail in Section 5.2.



Figure 1.6 Left: The Micravac (left) (Manus Coffey). Right: The Dung Beetle (J.Hvidtved Larsen)

When designing or selecting appropriate and effective methods and equipment for pit emptying, a number of factors specific to the site and the sanitation system must be considered:

- **Effectiveness:** How well does this method fit the characteristics of the target sites (access), pits and sludge (does this kind of method/technology work for this kind of sludge)? How well does this method interface with options for transporting the sludge to disposal site?
- **Safety:** What are the risks of workers being exposed to pathogens during emptying by this method? What are the risks of the household environment (ground, tools, taps, etc.) becoming contaminated by pathogens during emptying by this method?
- **Costs:** How much will it cost to empty a pit considering labour and equipment costs (overhead, operations and maintenance), transport and disposal costs and emptying frequency?
- **Sustainability:** Can the equipment used for this method be manufactured and repaired locally? Is it durable enough to stand up under the conditions of abuse or neglect that might realistically be expected in the actual context it will be used? Is it affordable for small entrepreneurs?

For this project, the following prototypes were developed with an aim to providing tools to overcoming the varying challenges found under different conditions.

- ❖ A **hand tool** was designed which proved too heavy to be used effectively.
- ❖ A **manually operated auger** was developed. The speed required to effectively lift waste proved too fast for manual operation.

- ❖ **Pit Screw Auger.** The manual auger was developed into a fully mechanised auger which has proven effective in lifting drier sludge under controlled conditions.
- ❖ **Gobbler.** The design principles using scoops and a chain used for the Nibbler were developed further.
- ❖ **NanoVac.** A vacuum technology using piston pumps which has proven effective for pumping wetter sludge under controlled conditions.
- ❖ **eVac.** A vacuum technology using a vane pump which has proven effective for pumping wetter sludge under controlled conditions.
- ❖ A **pressure vessel** was developed which can either collect sludge or pump air or water into a pit to aid sludge removal.

While a number of these technologies have proved effective when trialled on pig slurry, to date only the eVac appears to have significant potential for usage in field conditions with actual pit latrines, and then only with wetter sludge which does not have a high solid waste content. This is however useful as such sludge cannot be easily emptied by hand.

The balance of this report describes the work done and the lessons learned in the process of researching the above concepts.

2 TOOL TO AID MANUAL EXHAUSTION

The possibility of modifying existing tools to produce an enclosed spade in order to aid manual exhaustion was explored. The design concept was that the tool should enable a pit emptier to remain outside of the pit when extracting waste and to increase the rate at which the waste is removed. In addition, the tool should be inexpensive, light weight, easy to operate and have few moving parts.

A simple 'Mark 1', prototype hand tool was made, following the production of a number of card sketch models. The photos below show the original sketch model and the final prototype design of the enclosed spade.



Figure 2.1 Open and closed positions of sketch model of enclosed spade

Using the sketch models a prototype was built. The design was modified as it became clear that a solid mouth was unnecessary. A pitch fork closes over the mouth of the enclosed spade. The pitch fork is actuated with a reversing mechanism which opens the fork when you push on the handle (put the tool into waste) and closes it when you pull (take the tool out of the waste).



Figure 2.2 Actuation of enclosed spade from open to closed positions

The design was marginally effective at lifting waste. The piercing action of the fork mouth (as opposed to a solid sheet mouth) made the reversing mechanism fairly redundant. The original intent was to force a solid mouth to close when lifting waste as the weight of the waste might encourage a solid mouth to open on lifting the tool. With the improved forked mouth this tendency to open is eliminated as the weight of the waste has little effect on the movement of the forks

Due to the limited success of this design, further development was stopped. The total weight of the tool was far too high due to the steel construction. For this design to be functional, the following is recommended:

- Both short and long versions of the tool should be developed: the shorter to be used first when the sludge level is higher and the longer to be used when the emptier is working at a deeper level in the pit.
- Pit emptiers should work in pairs, with each having both short and long versions of the tool. One could then dig sludge from the pit and switch tools with the other who would empty the sludge into the container or burial pit.
- While holding the waste in the container using forks rather than a solid mouth appears to be effective, the design needs to be further modified to significantly reduce the weight of the tool.

3 THE GOBBLER

While the development of the Nibbler in Tanzania was limited by the availability of parts and technology, South Africa's well developed market for agricultural machinery offered a wider range of options. The Gobbler – a more robust version of the Nibbler – was developed as part of this research.

3.1 Design development

The initial prototype, which cost approximately R10 000 to develop, included a bend in the path of the chain to allow gravity to assist in pulling the pit sludge off the chain. As it would be difficult to guide a single chain and scoops around a bend without the scoops fouling on any guiding mechanism on the inside of the bend, the design utilised two chains rather than the one seen in the Nibbler. The use of two chains gave the design advantage of being able to place the scoops between them, leaving both sides of the chains clear for guiding. Guiding the chains, however, proved to be a major design challenge. Initially, a steel channel was used to guide the chain along its curved path. However, sludge quickly jammed the spaces between the chain and the steel channel chain guide. Additionally, the gaps between the rollers in the chain jammed, causing the chain to ride off the sprockets, resulting in further jamming.

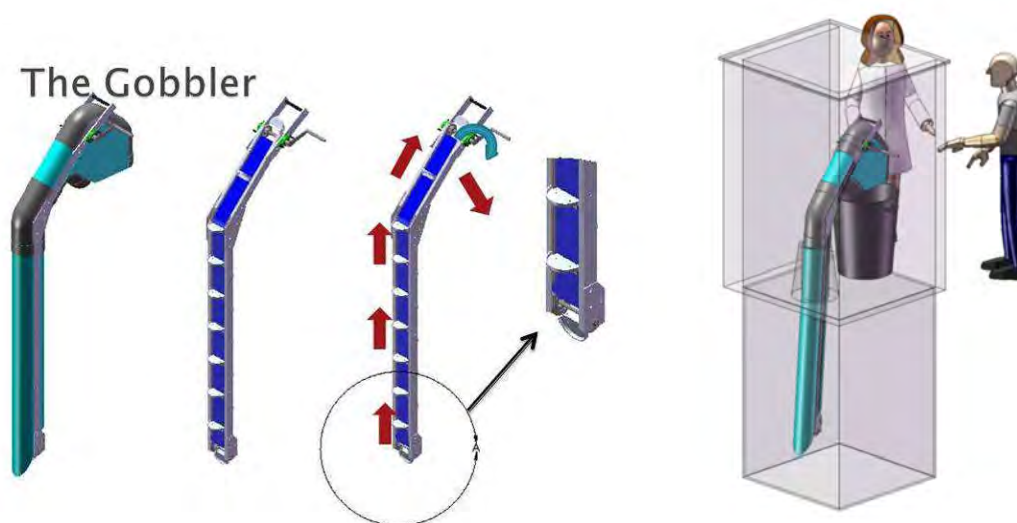

Figure 3.1 Initial design concept for the Gobbler

The steel channel was then replaced with sprockets keyed onto shafts to keep them in phase on the top and bottom shafts. Sprockets were also used to guide the chain around the inside of the bend. To overcome the issues of the scoops clashing with the sprocket axles, large 38 toothed sprockets were used which moved the shaft out of the path of the scoops. A lighter, stronger frame was built.

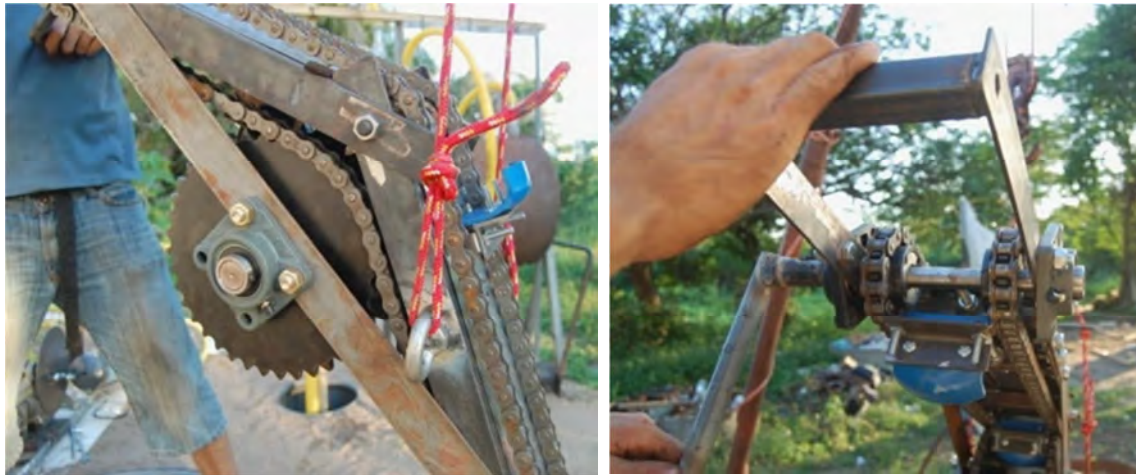

Figure 3.2. First Gobbler prototype

However, sludge jammed the sprocket teeth and prevented the rolling elements of the chain from seating properly on the sprocket. As a result, the chain was forced to follow a larger arc around the base sprocket, increasing the tension in the chain and eventually causing the mechanism to lock. It was thought that a more consistent chain speed and higher power source (as compared to manual turning) might overcome this issue, so a small (0.125 kW) motor was mounted on to the drive shaft to move the chains. Though this drove the chains smoothly and consistently when out of the sludge, as soon as pit sludge was introduced the system would again lock up. Additionally the drive system was quite dangerous as there were many moving parts (chains, scoops, sprockets) which the user's fingers or clothes could get caught on.

Guiding the chains around a bend proved to be complex and costly, with chains frequently jamming when coming into contact with the waste. After further discussions with Steve Sugden, a sprung scraper was added to remove waste from the scoops which allowed the entire design to be simplified significantly: the bend in the chain was eliminated and only a single chain was needed and the cog was removed from the bottom of the mechanism.



Figure 3.3 Second prototype of Gobbler with single chain and sprung scraper

3.2 Evaluation

While the concept of the Gobbler potentially offers a simple mechanism which is in theory easy to use, field tests have demonstrated that it has a number of inherent limitations:

- The high part count results in complex fabrication, high costs, multiple failure modes and multiple maintenance points
- Manufacturing the scoops requires complex machining as there are no off the shelf parts
- The device is heavy: the chains alone weigh 20 kg
- Supporting the machine is challenging. A large tripod was needed to support the devices while they were being built, manhandled and tested. Even if the weight could be significantly reduced, the unit would be heavy, cumbersome and difficult to get near to or into a pit.
- Because the machine has a fixed length, it is unable to accommodate varying depth of pit. This could potentially be overcome by producing two versions of the machine in two lengths. This would also significantly increase the cost of the system.
- Shrouding the whole assembly would be quite hard.

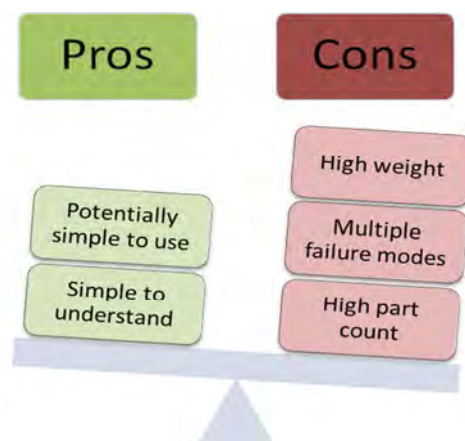

Figure 3.4 Pros and cons of the Gobbler design

If the Gobbler concept is pursued further, development should focus on:

- **Cost reduction** through selection of lower cost materials, plastics replaced with wood or bent metal sections, elimination of expensive fixtures and fittings, and cheaper chain and brackets
- **Part count reduction** to aid cost reduction, reduce complexity of manufacture and decrease failure modes
- **Weight reduction** through the use of thinner sheet steels and a lighter weight chain

4 PIT SCREW AUGER

Augers use a screw to lift material through a pipe. Initially a manually powered auger was tested, but the necessary rotational speed proved impractical; this led to the development of a fully mechanised auger. The intention was to produce a device that could be operated by a single person and remove dry waste from a pit through a pedestal and into a container.

4.1 Development of manually powered prototype

The project team attempted to bend discs cut from sheet steel into a helical shape and then weld these onto a central shaft. Pulling the helix proved very difficult; thinner sheet metal made bending easier but resulted in limited material upon which to weld. Eventually a relatively expensive post hole drilling auger was sourced. A modular injection moulded auger section or a part sourced from manufacturer which makes livestock feed moving machines are potential alternatives.

The post hole drilling auger fitted neatly into a 125 mm PVC pipe (700 mm auger with 100 mm pitched thread $\varnothing 100$ mm). The first test rig was manually powered and designed in such a way that the auger could be adjusted to various orientations and angles to see how well it picked up pit sludge. During initial manual tests the auger functioned successfully but needed to be cranked at uncomfortably high speeds to lift the pit sludge. The principle of lifting with a screw requires the force pushing the material upwards to be greater than the force pulling it downwards. In the case of an auger in a pipe, the friction between the pit sludge and the wall is created by the turning of the auger and will therefore be proportional to the turning speed. Therefore the faster the auger goes the more easily pit sludge will be pushed up the slope and lifted up the pipe. If the auger is turned too slowly then the pit sludge will not be lifted at all. The comfortable manual turning limit of 50-60rpm proved too slow to lift the sludge. The design was revised to include a motor.



Figure 4.1 Prototype of manual pit screw auger

4.2 Development of mechanised prototype

The objective in the development of the powered auger was that it should be simpler to make than the Gobbler prototype, be lighter and have a lower part count. As the test rig used for the manual PSA prototype had proven successful, an electric motor was mounted onto the same rig.

4.2.1 Power

A 0.25 kW motor (1400 RPM) with a 15:1 reduction gearbox was used, giving an output RPM of approximately 90. When an extension piece was added to the auger, however, the motor began to cut out frequently and a 20:1 box was tested to increase the torque on the auger with reduced loading on the motor. The rotational speed of the auger was too low, however, to significantly improve the lifting and extraction of waste. Testing demonstrated that there is a critical RPM below which no waste will be lifted. Above this RPM, the faster the auger turns the greater the flow rate of the lifted waste. With the 100 mm diameter/100 mm pitch auger, the critical RPM was found to be approximately 60. A 1.1 kW motor was added which provides greater power but also adds weight.

An offset gearbox which included chain and sprockets was tested in order to allow variation in gear ratios. The speed was increased from 60 RPM to 120 RPM, however the rate of removal remained static at approximately 25 litres per minute.



Figure 4.2 Offset gear box with chain and sprockets

4.2.2 Housing

Different diameters and internal finishes were tested for the pipe shrouding the auger. Using a helical lined pipe did not improve lifting but rather increased friction in the pipe. A 125 mm outside diameter pipe, with no helix, proved the most successful. The small 15 mm gap between the auger and pipe seemed to help lifting without resulting in too much friction. Due to the difficulty of removing rubbish causing blockages inside the housing, a hinged sleeve was produced which could be easily removed. During testing, however, it appeared that insufficient clearance inside the sleeve was responsible for the motor, which has a high torque cut off function, cutting out repeatedly.



Figure 4.3 Hinged sleeve enables blockages to be more easily removed

4.2.3 Intake

Testing demonstrated that if the auger protrudes approximately 5-10 cm from the bottom of the shroud it is better able to take up sludge. While the auger proved able to handle most rubbish present in the pits, larger objects and rags did occasionally jam the mechanism. A cage was then added to the bottom of the pipe to prevent larger objects from being taken up into the auger. However, sludge that was dense enough to hold its form would not fall into the cage, making it difficult for the screw to engage the sludge. In order to improve the flow of sludge toward the auger, the following modifications were made:

- The length of exposed auger was increased to 15 cm and the width of this bottom 15 cm of the auger increased from 3 cm to 5 cm. The aim was to increase the surface area in order to draw a greater radius of sludge into the auger while not increasing the dimensions of the bottom of the screw so much that sludge would be pushed off the screw where it enters the sleeve.
- Three blades were added to the bottom of the screw to increase the auger's ability to cut through waste and draw dense waste into the screw.



Figure 4.4 Blades added to auger point

During testing it was found that even when RPM was doubled from 60 to 120 (described under

Power above) the rate of sludge removal remained constant. The limiting factor was found to be the auger point itself – the length of the auger protruding, the diameter and the pitch.

The length of the protruding auger point is equal to the depth of sludge in a pit which the auger is unable to lift. While the exposed auger point was kept to a minimum for this reason (10 cm), this limits the rate at which the sludge falls into the auger and subsequently the rate of removal. Because leaving a small amount of sludge in the pit seeds the pit with a functional microbial population and speeds up degradation processes, it is not necessary to fully empty the pit. On balance it is felt that it is not essential to fully empty the pit (to leave some sludge is desirable) and to an extent percentage of total removal can be relaxed if the process can be speeded up significantly.

Increasing the length of exposed auger from 10 cm to 20 cm would have the following effect on the required regularity of pit emptying²:

Typical pit dimensions: Length x Width x Depth = 1.2 m x 1.2 m x 1.5 m		
Protrusion of point	Removal allowed	Extension of pit lifespan
10 cm	Up to 2.02 m ³	11.2 years
20 cm	Up to 1.87 m ³	10.4 years

In summary, if there shows to be a strong positive correlation between the amount of auger exposed with increased flow rates of sludge removal, then the future work can be done to establish the protruding auger length which gives the optimum ratio of percentage removal against speed of emptying.

4.2.4 Discharge

Discharging the sludge from the top of the 700 mm auger proved challenging. The auger could achieve a 400 mm delivery head before the motor cut out, however the waste became progressively more compacted as it rose above the auger, tending to rise past the opening rather than falling out and then jamming beneath the motor. Initially, a small cut away was made in the pipe and fitted with a larger diameter pipe fitted at a 45 degree angle. A long radius elbow termination was also tested as it would produce a significantly higher termination than a 45 degree tee for the same length of screw auger. A short elbow was then trialled but the auger could not provide a delivery head round the bend. A 45 degree plate was also tested to see if it would reduce the friction between the waste and the top termination so that the pit sludge could exit more easily. This operated with similar success to the 45 degree tee, although some waste collected on the plate.

² Assuming a pit is used by a family of six with an accumulation rate of 30ℓ/capita/annum, an approximation that is reasonable if a pit is used correctly. However this will vary significantly with the quantity of solid waste that is disposed of in the pit.



Figure 4.5 Swept elbow termination compared with 45 degree tee termination (left), 45 degree tee with lay flat hose (centre) and 45 degree plate termination (right).

A further trial used two augers mounted with a gap between them. The waste compacted in the middle after it had been lifted by the lower auger, however, and the upper auger was unable to cut through the compacted waste to raise it further.

Testing demonstrated that a continuous length of auger is needed and that the outlet must be at or just above (within 50 mm) the top of the auger for waste to be easily forced out. It is important that the auger does not continue past the outlet as this will lift the pit sludge past the outlet, causing it to jam between the top of the auger and the bottom of the motor. Finally, a section of reverse screw auger mounted inside a 45 degree tee termination proved successful.

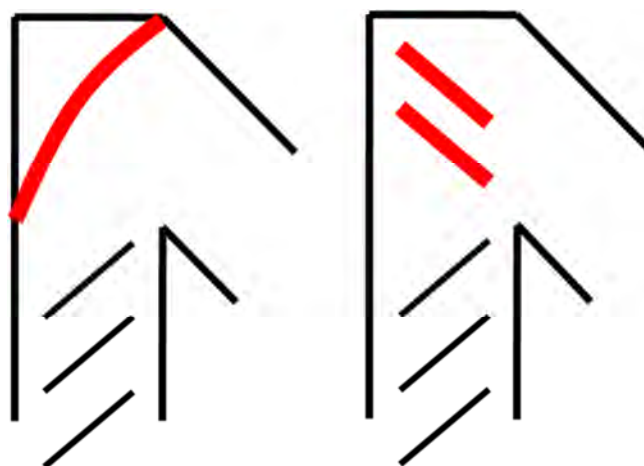

Figure 4.6 The addition of a short section of reversed auger at the top of the column makes it possible for the sludge to be ejected through the side opening.

Lay flat hose was used to direct the sludge from the termination of the auger to the collection bin. It was not always successful as kinks in the hose would sometimes prevent the sludge from discharging. A piece of heliflex hose was also tested, however pressure built up in the hose and the sludge was forced upward and eventually the bearing broke, leaving sludge trapped in the hose. A 1 m length of 110 mm flexible pipe attached (and removable for ease of cleaning) to the sludge outlet at the top of the auger was found to be more successful.



Figure 4.7 Flexible pipe on outlet

Previously sludge dropped from the drop opening, which resulted in difficulty in directing it to a storage contained. The container and auger had to be held continuously in place to prevent sludge from dropping back down into the pit (or splashing on to the auger itself creating more mess). The flexible pipe was fitted to enable sludge to be directed straight into the chosen collection vessel whilst significantly reducing operator contact with the sludge. In addition, a hook was added from which to suspend the bucket during emptying.

It was found that before making its way down the pipe sludge built up and was forced out of small openings in the auger – at the side hole that was left open to aid cleaning and through the top by the bearing. These holes need to be sealed as much as possible and the pipe should possibly be shortened to minimise this problem.

4.2.5 Extension

Initially, the shrouding was mounted in such a way that it was modular and extendable. To add the extension piece, the shrouding had to be removed, the extension screwed on, the shrouding remounted and a shrouding extension mounted. Since the mechanism measured over 2 meters in length with the extension, under conditions where a pit was emptied directly through the pedestal it would have to be coupled with part of the auger in the pit. Clips were used to join the sections as PVC adapters are not available in 125 mm pipe. These were inexpensive but proved cumbersome to use and to mount. Fifty millimetre axial slots were cut in the end of the shrouding to enable it to be slid more easily into a fitting. While the extension almost doubled the length of the auger, the relative lifting distance was still not very great.



Figure 4.8 Adding an extension to the auger

4.2.6 Support

Initially, the auger was hung from a bungee cord during operation to enable the user to bounce and manipulate the auger into different areas of the pit to extract waste. This was not very user friendly. The auger was then mounted on a ball joint which could be lifted up and down on a jack. While this proved effective, it added clutter to the area around the waste outlet. A tripod was then tried, which was effective but did not provide a means for the auger to be raised or lowered, making it difficult to manoeuvre the mechanism in the pit. A 3 m collapsible tripod was then manufactured from lightweight steel piping. Hanging the auger from a chain block was also tried and ultimately this proved most effective.



Figure 4.9. Using a tripod to support the Pit Sludge Auger while it is manoeuvred around the sludge

A number of design ideas were explored to support the auger inside a toilet superstructure. These included an A frame stand which could be assembled inside the latrine, a frame which gave a hanging point of the roof of the latrine and a supporting jack. All were tested but none proved completely successful.

4.3 Testing

A series of tests was conducted using simulated pit latrine sludge. Newspaper, rags and plastic bags were added to pig slurry to more closely approximate the waste found in pit latrines as follows:

Test 1: Pig slurry only.

Test 2: Fifteen coarsely ripped up broadsheet newspapers were added and mixed in.

Test 3: Two plastic bags full of coarsely ripped up rags were added.

Test 4: Six plastic bin liners were added and mixed in.

The auger performed well during all tests and there was no significant reduction in the time taken to empty the pit when the consistency of the slurry was varied. Newspapers disintegrated very quickly in the sludge and were easily removed by the auger. Likewise, the auger was able to take up the pieces of rag without jamming or blocking. The cage at the base of the auger successfully blocked the large plastic bin liners from being taken up by the screw (although it proved a messy task to remove these from the cage later.) For all testing rounds the rate of removal at the start of emptying was 25litres/minute; the rate slowed incrementally to 5litres/minute as the pit neared empty. Ninety percent of the pit was emptied in all cases; the length of the auger was inadequate to emptying the final 10% of the pit.



Figure 4.10 Pit screw auger during testing

After the width of the bottom 15 cm of the screw was increased, three small blades were added to the auger point and a removable sleeve was added, another controlled test (minus a cage) was carried out on a relatively dry pig slurry with newspaper, rages or plastic added as with the tests above. The auger was able to fill a 25 litre bucket in 38 seconds, which equates to a rate of 40 litres/minute - a considerable improvement on 25 litres/second.

4.3.1 Testing on pit latrine sludge

After numerous tests on pig slurry, it was felt that the auger was ready for testing in a real pit latrine. To do this the slab at the back of a full pit latrine was removed, and the auger was suspended from the tripod over this hole. Although the pit latrine sludge looked like it only had minimal rubbish in there was a considerable amount slightly below the surface. Rubbish included bags and clothing. The auger was moved to various positions around the pit but from none of these positions was it able to remove any sludge as rubbish immediately got caught in the screw.



Figure 4.11 Using the auger to empty a VIP pit (left). The amount of rubbish which the pit contained (right) made it impossible for the auger to remove sludge.

4.4 Evaluation

Relative to other design concepts explored, the auger has a number of advantages and appears to have some promise as a technology which can empty pits effectively in situations where access by standard vacuum tankers is impossible. One of the main disadvantages of the auger is its weight and size. Two meters of waste in a 125 mm pipe can weigh up to 20 kg. With a 4.5 kg x 2.5 m auger + 10 kg frame and motor, the operator is required to lift 40 kg, which is the maximum that one person can comfortably lift. This makes the auger relatively difficult to manoeuvre inside the pit.

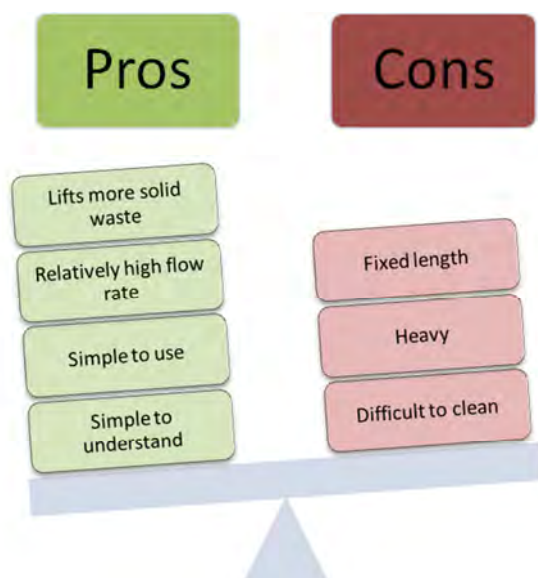

Figure 4.12 Advantages and disadvantages of the Pit Screw Auger

4.5 Recommendations for further development

- **Dealing with rubbish in the pit.** The rubbish frequently found in VIP pits presents a real obstacle to virtually any kind of mechanized device attempting to empty the pit, including the auger. Some rubbish can be raked out of the pit manually before emptying, but it is impossible to remove all of the rubbish in this way and the process of removing rubbish can be messy. A waste shredder could be made to shred everything in the pit before emptying.
- **Reduce weight.** A smaller diameter auger could greatly reduce the weight of the system, as could the option of having the motor on the floor, driving the auger via a flexible drive shaft, or a hydraulic system. As an internal combustion engine has higher power density than an electric motor, it may be worth considering.
- **Improve manoeuvrability.** The auger is difficult to manoeuvre due to its large size and weight. One way this problem could be overcome would be to develop a different arrangement in which the auger remains stationary and pit emptiers manually direct sludge to it. This would allow the auger to be quite long and designed simply to deliver the pit sludge to a spillover dish/pan from where it could be manually slid off into containers. Its weight would not be problematic as the device would only be carried when empty. This would also permit a significantly larger engine.
- **Modularity.** A modular design proved unsuitable as it would bring the operator into contact with faeces while assembling and disassembling contaminated parts. Better options may be to have longer and shorter versions of the auger for working at different pit depths, or incorporating two outlets into the design of a single long unit.
- **Extension.** While the length of the prototype at present is approximately 1.5 m, in order to empty a 2 m deep pit a total length of approximately 2.8 m would be optimal.

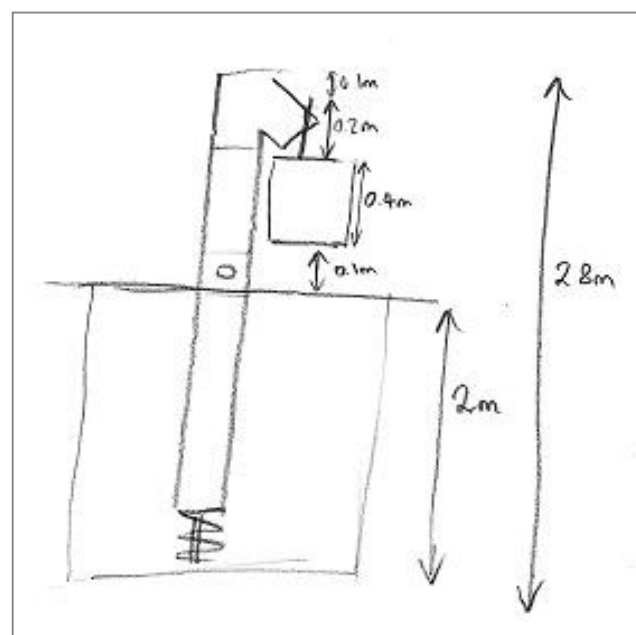
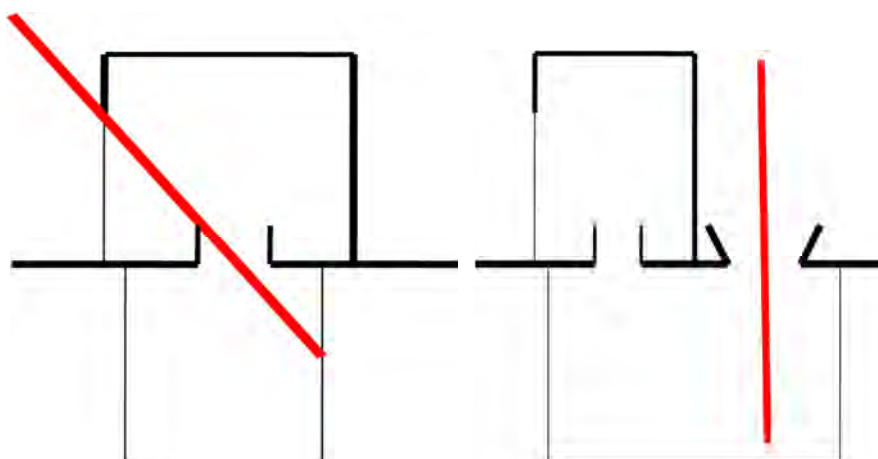

Figure 4.13 A total length of 2.8 m is optimal for the auger

Further investigation is needed of ways to reduce contact between operator and the sludge, particularly during storage, transport and cleaning.

- **Storage and Transportation.** An appropriate container and method of transportation needs to be identified to reduce contact between the sludge and workers.
- **Cleaning.** Cleaning the auger involves unacceptable levels of contact between the worker and sludge. Specific equipment and products should be explored for cleaning the auger both at the site where the pit is being emptied and at the end of a day of operation.
- **Support.** While the tripod provides an adequate support frame for the auger, it does not allow for the mechanism to be raised or lowered into the pit, making it difficult to manoeuvre the auger inside the pit. Further consideration also needs to be given to supporting and manipulating the auger inside of a toilet superstructure.
- **Accessing pit.** A fixed length machine such as the auger or Gobbler presents a problem if there is no access hatch to the pit external to the superstructure meaning that the pit must be emptied through the pedestal.

Figure 4.14 The fixed length of the auger presents a problem where a pit must be accessed through the pedestal (left) rather than through an access hatch (right)



It may be worthwhile to develop a prototype that could be inserted into the pit through a back opening or hole in the side wall of the pit, while waste is directed towards the auger's inlet using hand held tools through the VIP's pedestal opening.

Figure 4.15 Concept for a stationary auger operated from outside of the structure

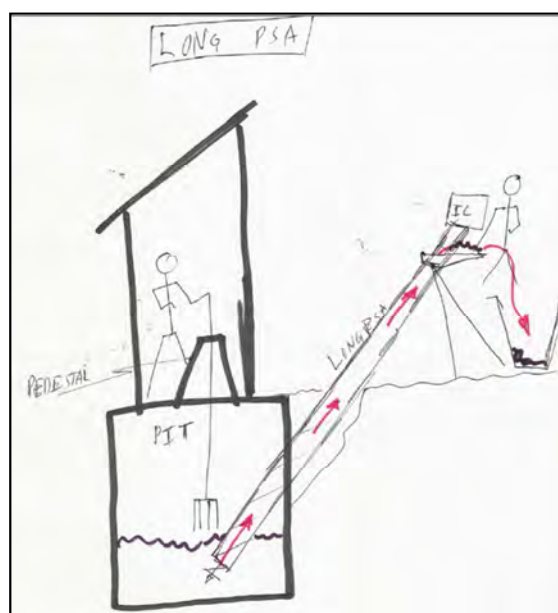

5 Investigating vacuum technologies

5.1 Pros and cons of vacuum systems

While vacuum-based technologies are the most widely used mechanised systems for emptying pits, the performance of any vacuum-based system is affected by the height to which sludge must be pumped into the tank, the depth, density and viscosity of the waste in the pit and the length and inside surfacing of the suction hoses. A suction system has advantages compared to other systems (such as augers, scoops and diaphragm pumps) when the following constraints on pit latrine emptying are considered:

- With the mixed and variable solid characteristics, moisture content and abrasiveness of pit contents, a vacuum system works better than a system which requires sludge to pass through the pump mechanism. Diaphragm pumps can be used to extract the more liquid sludge from storage tanks but would require frequent maintenance due to blockages by rubbish.
- At sites where access to both the housing plot and to pit contents is difficult, a vacuum system can be used with the main tank and power source up to 50 metres away.
- A vacuum system (as long as the pipes remain unblocked) allows contact with sludge during emptying to be more easily prevented.
- A vacuum system (as long as the pipes remain unblocked) overcomes social nuisances associated with pit emptying such as odour and fly nuisance.

Standard vacuum tankers, however, have a number of drawbacks:

- There must be vehicle access to at least 50 metres (preferably 30 metres) from the site.
- The vacuum tanker must be able to park not more than two metres above the site that is to be emptied
- Capital, operation and maintenance costs are high
- Parts – particularly the vacuum pump – can be difficult to source
- Variability of faecal sludge viscosity influences performance and makes pricing difficult

5.2 Vacuum principles

Theoretically, the maximum vacuum that is possible is 1 bar (-10.19 m of water) pressure. However, the vacuum on a new tanker is typically 0.8 bar (8.0 m water), and once the pump on a tanker is worn, the vacuum is typically 0.5 bar (5.0 m. water). In comparison, the vacuum that can be achieved on a manually powered device such as the MAPET is 0.3 to 0.4 bar, while the vacuum on a domestic vacuum cleaner is 0.1 to 0.3 bar.

The necessary pumping head of a vacuum tanker is determined by the depth below ground level at which the waste must be accessed from the pit, the position of the entry point of the vacuum hose into the tanker and the height above ground level at which waste is deposited into the tanker. The

height of the tanker is therefore critical. As the pit is emptied, three factors combine which reduce the performance of the tanker:

- Waste is sucked from a greater depth
- The waste level rises as the tanker fills
- The waste density and viscosity of the material that is being sucked increases as lower levels of the pit where settling has occurred are accessed

The vacuum performance of the tanker is measured at the truck and determined by suction power (bar) and airflow (m^3/minute). Extraction inefficiencies such as pipe friction and air losses are not taken into account. In a typical situation, a vacuum truck's performance will be reduced to 0.5 bar (5.0 m water) due to wear. With a density of 1.5 sg for the sludge at the bottom of the pit and the truck filled with sludge to a height of 2.5 m, the static head would be calculated as: $5.0/1.5 = 3.2$ m. The truck's capacity to vacuum, however, would be calculated as: $3.2-2.5$ m = only 0.8 m below ground level.

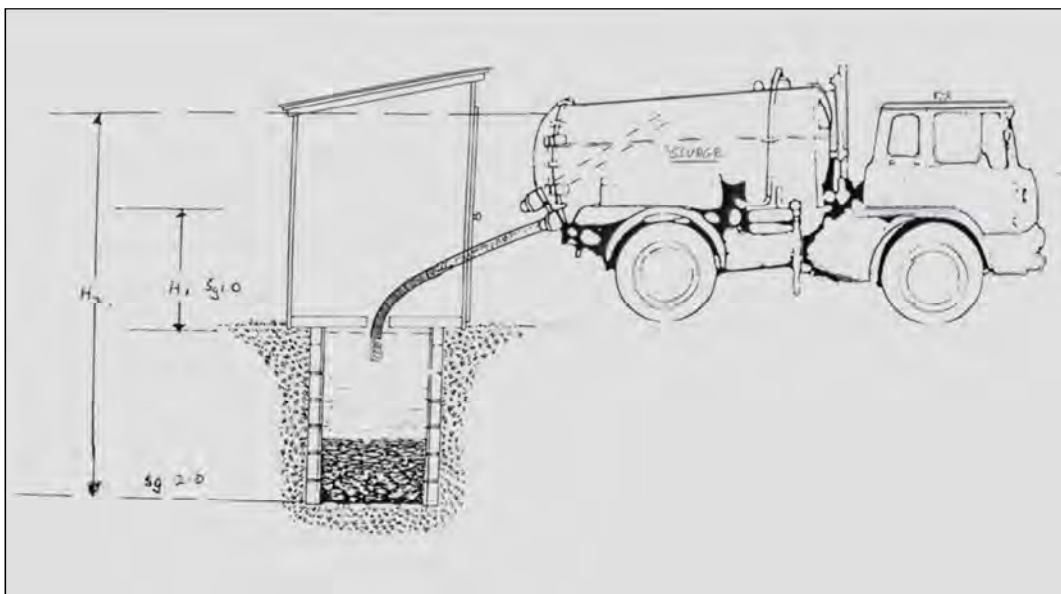

Figure 5.1 This vacuum tanker will need more than six times the vacuum power at the bottom of the pit than at the top (Manus Coffey)

When operating on dense wastes, air can enter the hose and break the flow. Various approaches can be used to deal with this. With a high vacuum/low airflow approach, the hose is submerged deep under the sludge, and atmospheric pressure (P_a) acting on the surface forces the sludge along the hose into the holding vacuum tank (at vacuum pressure P_y). Figure 5.2 illustrates this situation.

With a low vacuum/high airflow approach, air is constantly dragged through the system and particles of sludge are suspended in the very high air stream and drawn along the hose into the holding tank, as with a domestic vacuum cleaner. Figure 5.3 and 5.4 illustrate this point.

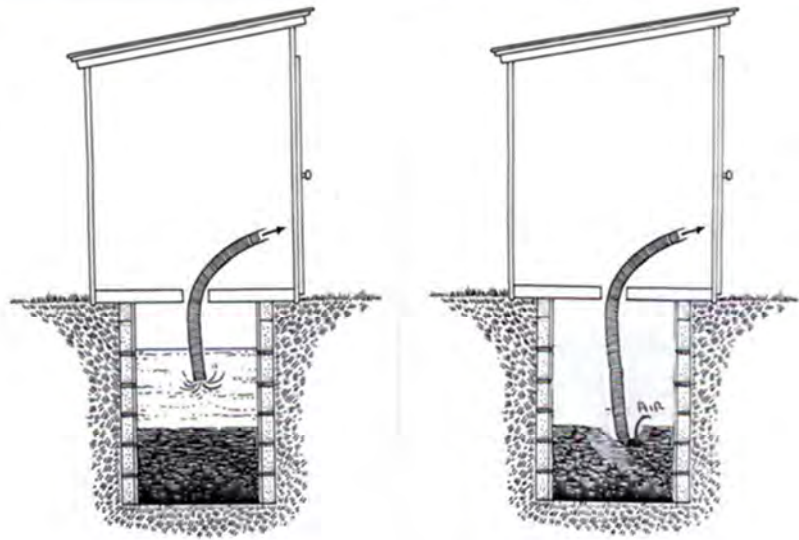

Figure 5.2 Air can enter the hose and break the flow when vacuuming dry sludge (Manus Coffey)

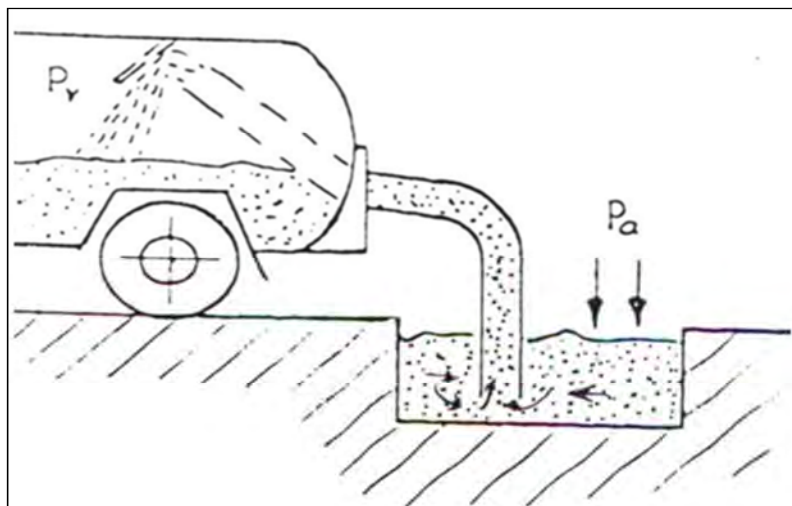

Figure 5.3 High vacuum/low airflow approach (Manus Coffey)

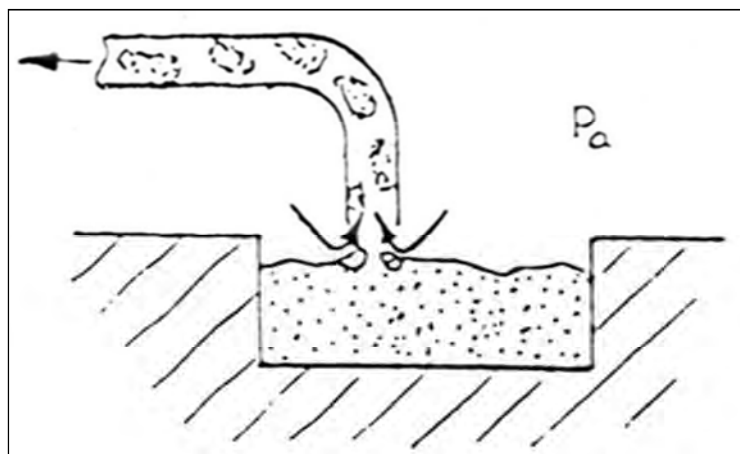

Figure 5.4 Air drag system with a low vacuum/high airflow approach (Manus Coffey)

An air bleed system can also be used, where a pipe is inserted into the sludge. With a combination of high vacuum and medium airflow, the atmospheric pressure (P_a) forces air down the air bleed pipe and thus maintains the airflow necessary for the sludge particles to be suctioned.

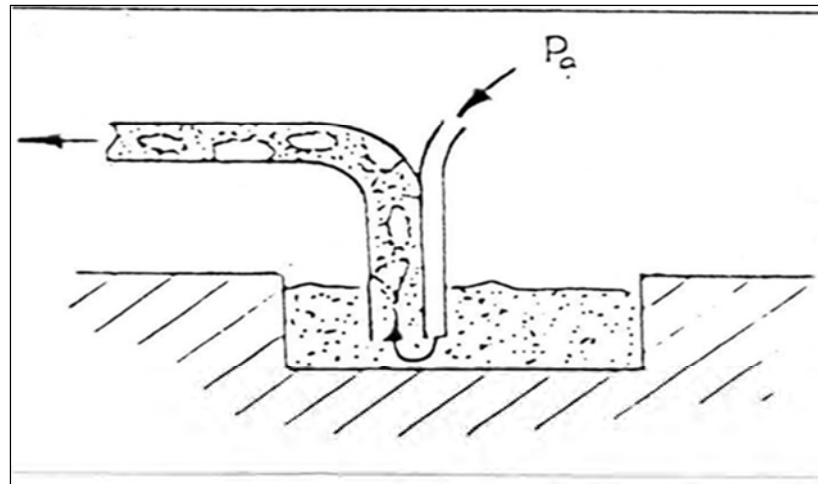

Figure 5.5 Air bleed system (Manus Coffey)

With a plug and drag system, a combination of high vacuum and medium airflow is used, with an air drag effect obtained by raising and lowering the hose inlet in and out of the sludge.

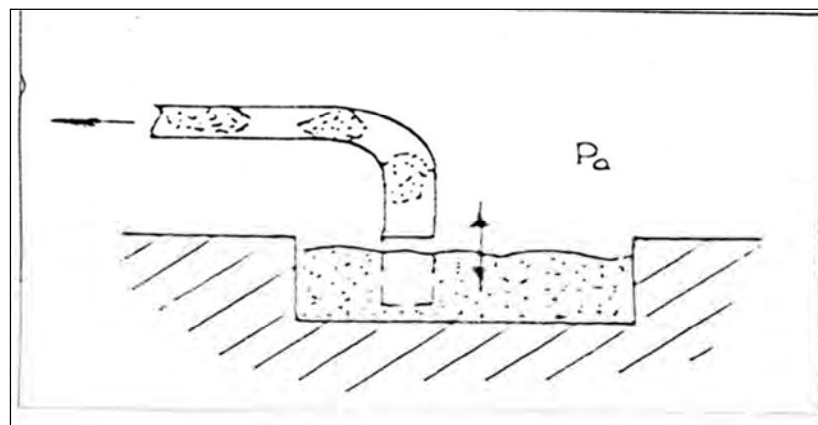

Figure 5.6 Plug and drag system (Manus Coffey)

5.3 Overcoming variability in sludge density

The consistency of the sludge in the pit is affected by the amount of water added to the pit (by flushing, disposal of greywater, or water used for anal cleansing), the ability of water to leave or enter the pit (determined by pit design, permeability of soil and level of water table relative to the pit) the type of anal cleansing material used, presence of other solid or liquid waste in the pit and diet. The density of sludge increases with decomposition and settlement over time, with waste at top of the pit mainly water with specific gravity 1.0 and at bottom of the pit with specific gravity 1.5 to 2.0. As a result, it is often easy to extract the low density waste from the top of the pit, while the

high density sludge which progressively builds up at the bottom becomes increasingly difficult to remove.

In trials of various vacuum based machines, Manus Coffey and Associates found that sludge that is less than a year old is generally easy to remove by suction (Coffey, pers. comm). Sludge that is more than two years old is often too dry and dense to be removed by suction. Attempts to fluidize older sludge by adding water to the top were unsuccessful as the water simply floated at the top. Because vacuum tanker operators often cannot remove the densest sludge from the bottom of the pit, it builds up, reducing the volume of the pit over time. This is exacerbated when householders cannot afford to have their large pits emptied completely and only have the top, lower density waste removed.

When pit sludge is too dense to be effectively removed with a vacuum tanker, a small amount of water and low pressure compressed air can be introduced to the pit sludge. This has a surging and mixing action which can fluidize dense wastes and make them suckable. Experimental work was done by Jamie Radford on fluidizing sludge using ± 0.3 bar vacuum/pressure provided by a low cost, high powered domestic vacuum cleaner at a cost of only 10% of that of an engine powered pump.

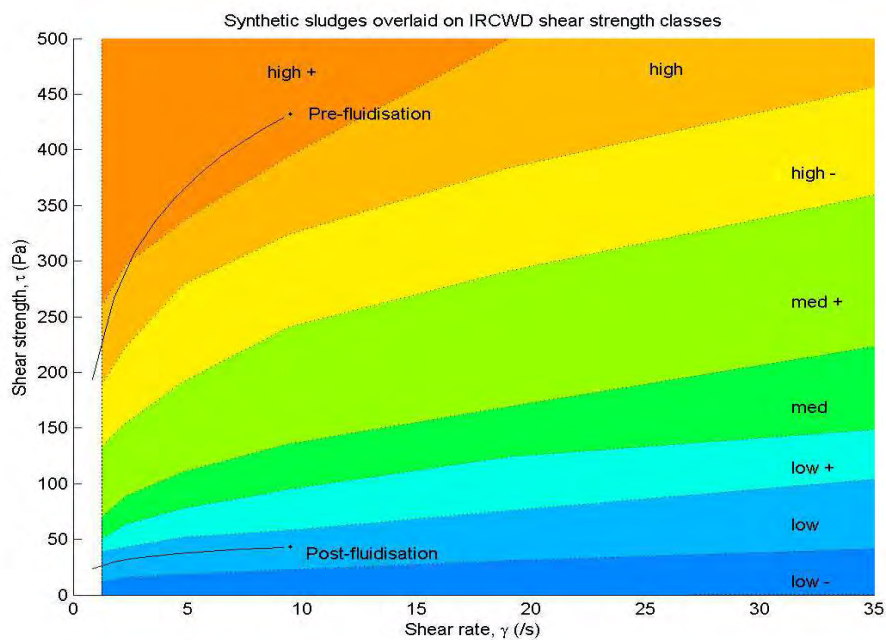

Figure 5.7. Effect of fluidisation on the shear characteristics of synthetic sludges (Radford)

Coffey proposes another approach to overcome this problem. An inexpensive concrete pit with a two year holding capacity is developed with a built-in suction hose which would allow sludge at the bottom of pits to be removed first, preventing build up. Water could also be pumped into this hose to fluidize sludge from the bottom. This is illustrated in Figure 5.8.

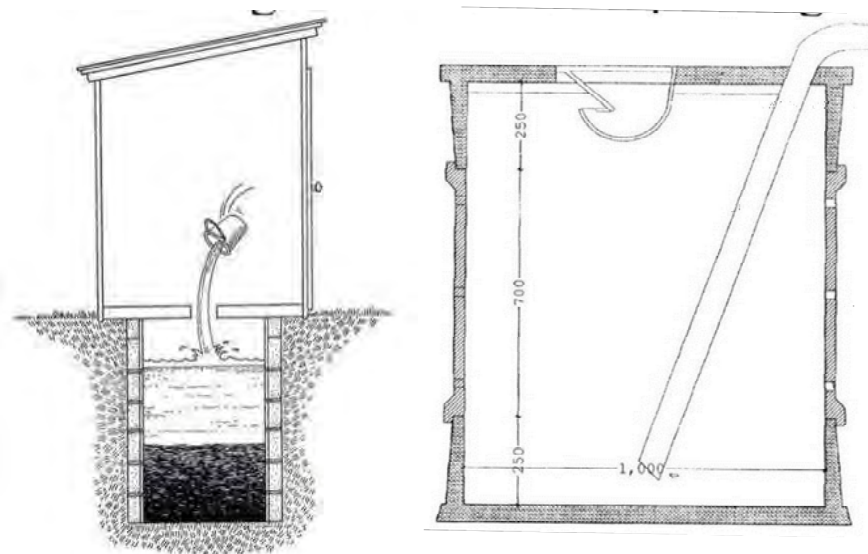

Figure 5.8 Water added to the sludge from above cannot adequately fluidize denser sludge at the bottom of the pit (left); UN-HABITAT proposed pre-cast concrete pit design with integrated suction hose may overcome this problem (right) (Manus Coffey)

Designing pits for mechanised emptying could reduce health risks to householders and operators, allow faster emptying/clean-up, prevent the risk of collapsing pits, and allow for the smaller pit design required in shallow soil and areas with a high water table.

5.4 Testing the Vacutug

The UN-HABITAT Vacutug project developed out of research which was started by the International Reference Center for Waste Disposal in Botswana in 1983 which produced the Brevac, a low cost vacuum tanker which inspired the development of the Micravac and MAPET systems.

The Vacutug comprises a 0.5 m³ steel vacuum tank connected to a sliding vane vacuum pump capable of -0.8 bar vacuum. The machine is equipped with a throttle, a clutch (in the form of an adjustable belt drive) and two brakes. A 4.1 kW petrol engine can be connected either to the vacuum pump or a friction roller to drive the front wheels through an adjustable belt drive. The vacuum tank is fitted with 3 inch diameter valves at the top and bottom of the tank and the waste is evacuated from the pit via a 3-inch diameter PVC vacuum hose. The sludge can be discharged under gravity or by slight pressurization of the vacuum tank by the pump.



Figure 5.9 The UN-HABITAT Vacutug (UN-HABITAT)

In February 2009, a member of the WRC project team visited UN-Habitat in Nairobi to learn more about this technology and discuss issues and methods of latrine emptying. Key issues for operating the Vacutug successfully were understanding how to use the belt drive as a clutch, the extension of the back axle and the system for locking the roller drive wheel onto the driving tyres which, when combined with the use of the belt drive as a clutch, aids manoeuvring the Vacutug and climbing slopes considerably.

For testing the Vacutug, a community with low flush systems was identified in Msunduzi Municipality. It proved impractical to transport the Vacutug to the test site on the bed of a pick-up truck and a tipper trailer had to be hired. Although the terrain was relatively flat, it was found that the Vacutug struggled to propel itself over uneven surfaces and there was a risk of it tipping over.



Figure 5.10 The size of the Vacutug compared to 1 ton bakkie (left) and the Vacutug unable to power itself over a small earth ridge (right).

While the presence of rubbish is a serious obstacle to emptying VIP pits with a vacuum technology, it was expected that the soak pits of low flush systems would not contain rubbish as it is more difficult to dispose of rubbish through a flush pedestal than an open pedestal over a pit. However a fair amount of rubbish was found in the low flush pits, possibly disposed of directly into the pit. Removing rubbish prior to vacuuming proved time consuming. If a piece of rubbish was overlooked and blocked the pipe, it could result in a delay of as much as 1.5 hours. In addition, despite the use of flush water in these systems, the sludge in some of the pits was relatively dry, increasing the time required to empty the pit by 15 minutes or more. By adding 40 to 80 litres of water to the pit the sludge became fluid enough to remove.



Figure 5.11 Rubbish being removed from a pit with a rake (left). Using the Vacutug hose to mix water with sludge inside the tank (right).

When the Vacutug reached capacity the sludge was transferred to a 5000 litre holding tank which when full was emptied by a municipal vacuum tanker.

Use of the Vacutug proved both efficient at cost effective at ZAR250/m³ sludge removed, excluding the cost to empty the transfer tank. Two people were employed for this operation. A total of thirty nine households were serviced involving some eighty trips in the space of about one month. The median value that families were prepared to pay was R175. If at least four houses are serviced per day at this rate, a minimum of R700 can be earned daily. From this amount the costs of fuel, machinery maintenance and labour can be covered, with some margin for machine maintenance. It was observed that five litres of fuel was needed to service five latrines. The municipal vacuum tanker would typically take less than fifteen minutes to empty the full 5 m³ JoJo tank.

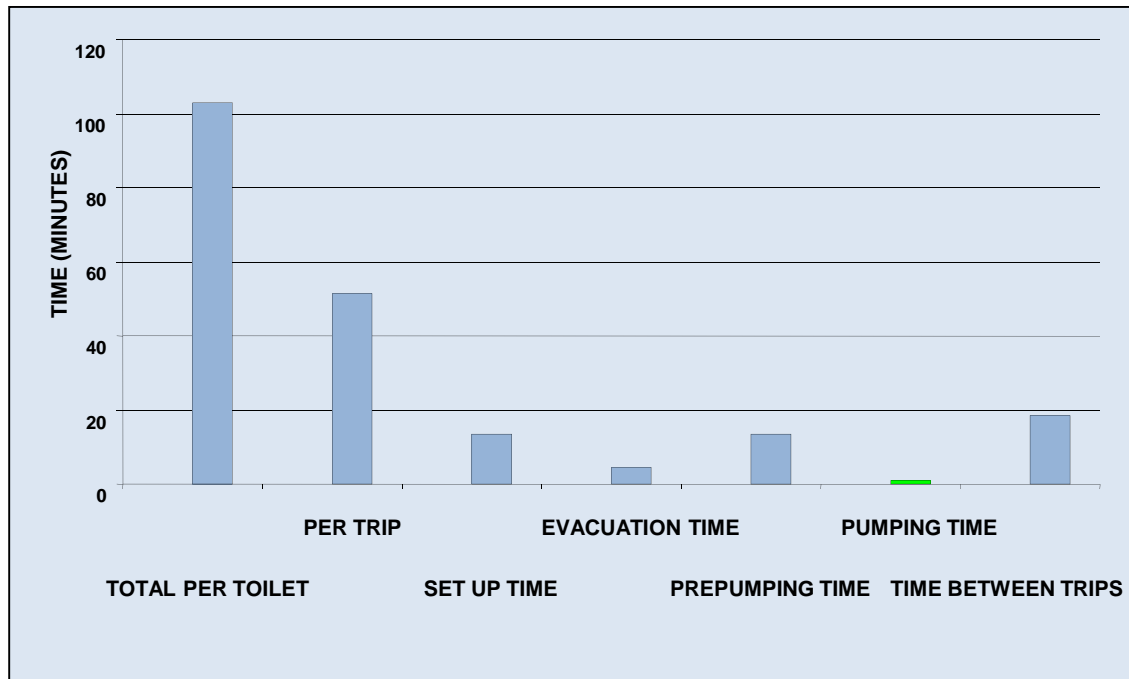

Figure 5.12 Analysis of time taken to empty 1 cubic metre low flush soak pits using Vacutug

6 THE NANO VAC

The development of the MAPET system in Dar es Salaam in 1990s, though ultimately unsuccessful, proved that piston pumps can achieve the vacuum pressures required for sucking liquid wastes out of latrine pits, creating possibilities for low-cost vacuum technologies which could work in parallel with technologies designed for the extraction of denser pit sludge. The image below illustrates the initial concept for a NanoVac, based largely on the MAPET system but driven by an internal combustion engine. The objective was to create a vacuum-based technology that was low cost, compact, easily manoeuvrable and easy to repair and maintain. As integrating exhaustion and carting systems has proven impractical unless on a large scale such as a vacuum tanker, the mechanism needed to discharge directly into a transporting container or suck sludge into a vacuum chamber and then blow it back into the transporting container.

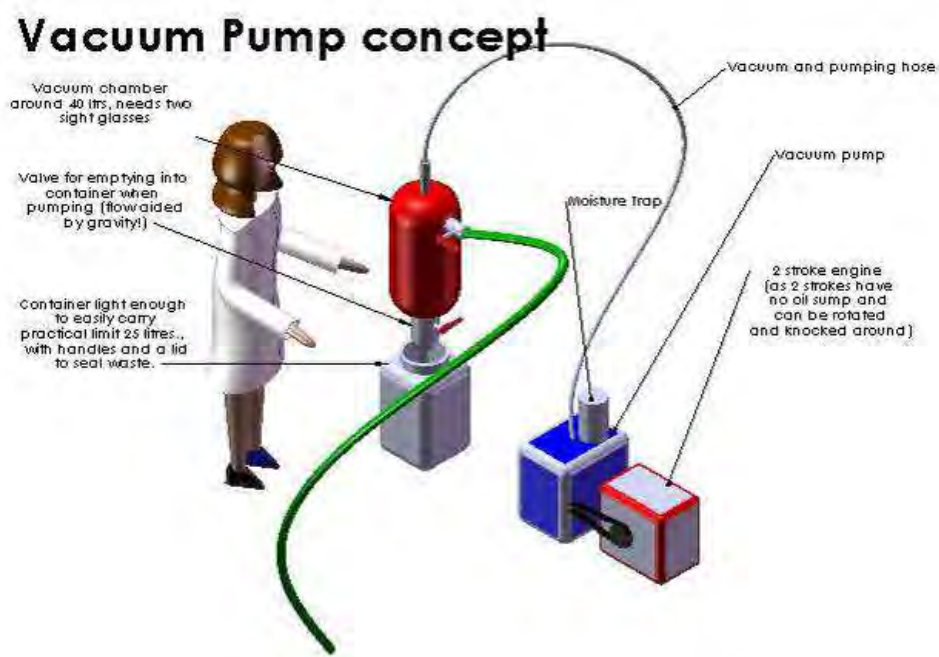

Figure 6.1 The original NanoVac concept. The red container would be alternately filled and emptied

6.1 Design and development

Initially the NanoVac was designed, like the MAPET, with two large diameter piston pumps to suck and blow air, rotating 180 degrees out of phase to reduce cyclic loading on parts. The pistons seals were made from cheap leather cut from a welder's apron (100 ZAR) so that they could be easily replaced. Sludge was pumped into a large diameter drum mounted on a frame which could be rotated for filling and emptying in a manner similar to the MAPET system. An 1 kW electric engine was initially used with an 80 mm/800 mm pulley system for speed reduction.



Figure 6.2 First NanoVac prototype test rig

A test rig was designed, using a pit filled with water, to test the first pump and tank fabrications and to see how the variation of stroke length and RPM affected the suction developed by the pump. The suction hose was mounted on a vertical pole to allow measurement of water column height over time as the pump drew the water out of the test pit and into the vacuum tank. It was found that the longer the stroke length the faster the pit was emptied, up to a limit where the pump became overloaded. The stroke length on the test rig could be varied between 100 and 300 mm; 150 mm proved a good compromise between stroke length and pump loading. When using a fixed stroke length, the higher the RPM the faster the pit was emptied because more air was displaced over the same length of time. With very short stroke lengths, high RPMs were not effective as the air was just 'excited' inside the piston and did not actually act to create a vacuum, while with very long strokes the motor struggled to turn the cranks at high speeds due to the larger turning moments of the pistons. A compromise between a longer stroke length (150 mm) and faster RPM (200 RPM) is optimal. The bottom of the piston stroke should come to just above the check valves to minimize the 'unexcited' air in the piston. While tests using water were successful, using the NanoVac on pig slurry resulted in higher vacuum pressures which caused structural damage.

The test rig was modified to take a 5.5 hp IC engine so that it could be used in areas where electricity is not available. The engine also provides significant capacity for over design. A 1:20 reduction box was used along with a 1.5 reduction pulley drive to bring the IC RPM into line with the requirements. As the IC engine had excessive power availability the pump ran very well with extremely rapid pumping rates. The test rig itself did however show significant strain under the higher loads, requiring a stronger frame.

As an alternative to the reduction box, a design was developed using a large diameter (800 mm) wheel connected to the piston cranks in order to achieve the required speed reduction on the IC engine. A reduction wheel is durable and easily fabricated, enhancing the possibility for the design to be replicated where a gearbox may not be available. A gearbox allows a much more compact assembly, however. In addition, testing demonstrated that a single piston can be used effectively with a gear box, overcoming any negative effect by using the additional power of an IC engine to increase the stroke length. If a large reduction wheel is used rather than a gear box, however, two pistons are preferable in order to better distribute loading on the structure. While an additional piston produces smoother engine loading and airflow profile, it increases the complexity of the plumbing. Nylon or metal brushes on the tops of pistons reduce wear on the plastic end caps. A

flywheel may be useful to smooth the cyclic loading of the pistons, although it would increase the weight and size of the pump.

During the development of the Nano Vac, the number of gate valves in the plumbing was reduced by using separate pumping and vacuum hoses. Venting gate valves (especially the blow line) were placed at ergonomic heights and vented downward. The moisture trap was removed as no moisture was seen in the system during the initial tests; however as dirt can be sucked into the mechanism a PVC moisture trap may be beneficial. Plumbing was simplified over the course of development and one inch hosing and fittings were eventually used throughout. Hoses were kept high off the ground to prevent the entry of dirt and attached to tanks and pumps with camlock fittings. To reduce the stress placed on the piston, the original steel shoulder was replaced with a lighter weight PVC part, and the position of the upper valve was moved closer to the body of the machine.

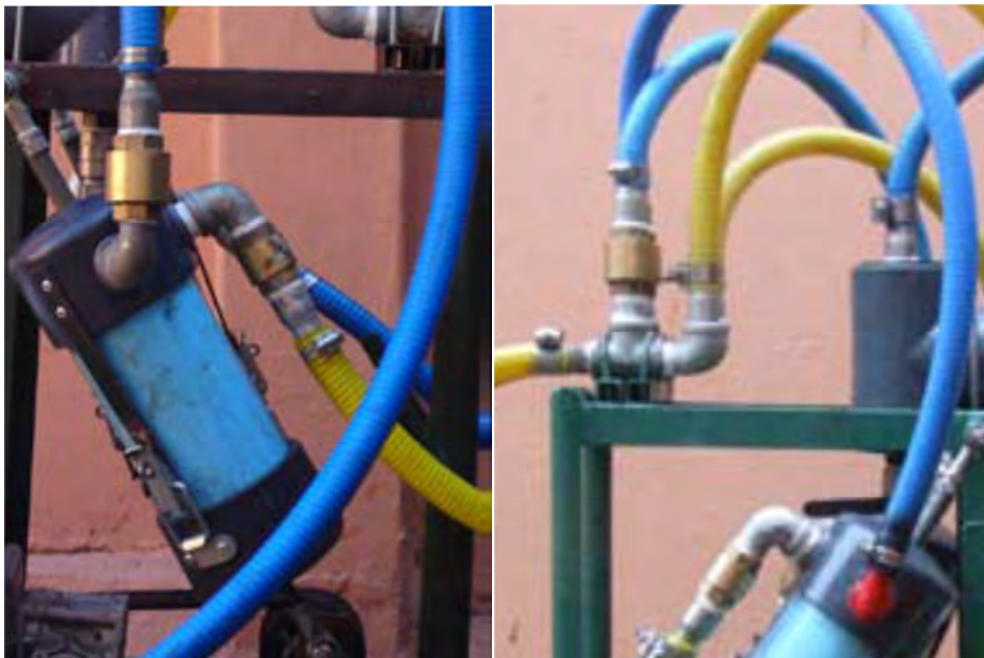

Figure 6.3 Upper valve moved from close to piston (left) to closer to the body of the machine (right)

Moving the lower valves closer to the body of the machine was also considered. However, this would extend the length of the unit substantially and put them at greater risk of being knocked and damaged. The pipe configuration was also changed so that both lower pipes were yellow and both upper pipes are blue to make connecting pipes correctly more intuitive for operators.



Figure 6.4 Configuration of pipes changed so that lower pipes are yellow and upper pipes are blue.

In addition, sockets colours were chosen to match the piping, and inlet and outlet pipes were labelled in English and Zulu.



Figure 6.5 Colour coding and labelling to aid correct operation

Initially, the NanoVac was able to achieve a positive pressure of 6 bars and a negative pressure of -0.8 bars. Smaller diameter fittings on the next prototype resulted in better seals which produced slightly higher vacuum pressures. Some strain and flexing in the pump structure was evident due to its relatively large size necessitated by the use of the large reduction wheel.

6.1.1 Pump

It was found that if the pump was switched to pumping mode before the tank was turned over into the pumping position sludge would flow back into the pump. If the pump hose was connected before the tank was rotated into the pumping position and the tank was rotated before the pumping was started, the pit sludge would flow back from the tank into the pump. This could be avoided by providing one connection for sucking at the top and another for blowing at the bottom. This would, however, increase the cost as well as the likelihood of blockages. A non-return valve could also be placed on the end of the blow hose attached to the vacuum tank to prevent back flow. Another option is to lead the blow above the top of the tank and back down to the pump, isolating the vacuum tank from the pump and preventing back flow.

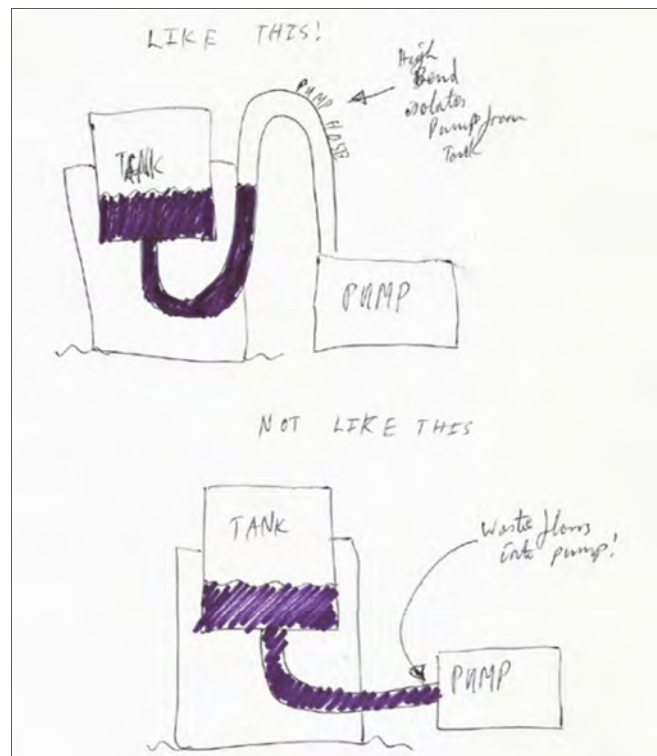

Figure 6.6 High bend in blow hose to prevent back flow of sludge



A special test rig was assembled to assess the ability of the Nano Vac to pump waste up hill. The pump was able to force up a vertical distance of 6 metres.

Figure 6.7 Testing the capacity of the Nano Vac to pump vertically

6.1.2 Vacuum tank

Initially, a steel drum was used as a vacuum tank to hold the sludge, but this proved cumbersome as a vacuum tank. A Hippo Roller – an 80 litre water carrier designed to be rolled along the ground – was tested as a vacuum tank with the idea that by sucking the pit sludge directly into a portable container which can simply be poured out, the need to suck and then blow from a vacuum tank would be eliminated. Under testing the roller tended to buckle slightly under a -0.25 bar vacuum. The ends were braced with a short length of pipe. This allowed a vacuum of over -0.3 bar to be reached, which was more than adequate as the roller was placed next to the pit and so required only a small head to fill. As an alternative vacuum chamber, a tipping tank was designed using a 48 kg domestic gas canister. The tipping design eliminated the need to rotate the tank, instead allowing it to simply be tipped from one orientation for filling to the other for emptying. A bleed valve on the tank is important if the tank is to be emptied by gravity.



Figure 6.8 Various containers trialled as vacuum tanks: steel drum (left); Hippo Roller (centre) and gas canister (right)

6.2 Evaluation

The concept of using a piston as a vacuum pump for sucking waste that is relatively liquid has proven effective with several different arrangements. The current prototype of the NanoVac is able to achieve a suction flow rate of 0.076 m³/min and a discharge flow rate of 0.112 m³/min.

It was however found to be not robust enough in field tests. If this concept were to be further pursued, work would have to be done on stiffening the frame (to reduce movement) and more hard wearing materials would have to be used for the pistons.

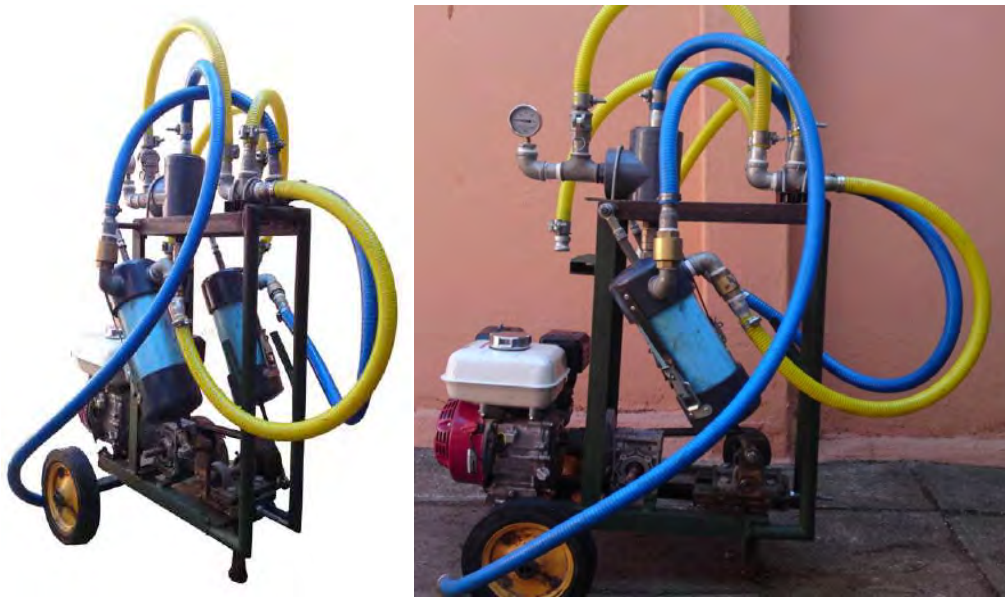

Figure 6.9 Current Nano Vac prototype

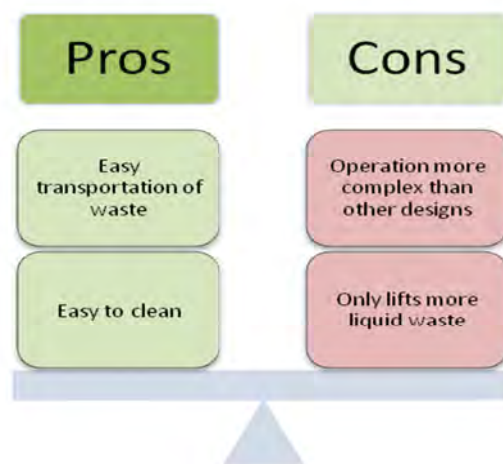

Figure 6.10 Advantages and disadvantages of NanoVac in comparison to other pit emptying technologies

Different design options may prove optimal for different contexts. In Figure 6.11 a tank and pump combination that would be appropriate for an entrepreneurial group in a situation with poor access to engineered components and processes is circled in purple. Two approaches which are more appropriate for a municipal pit emptying programme where complex engineering processes and components are available are circled in orange.

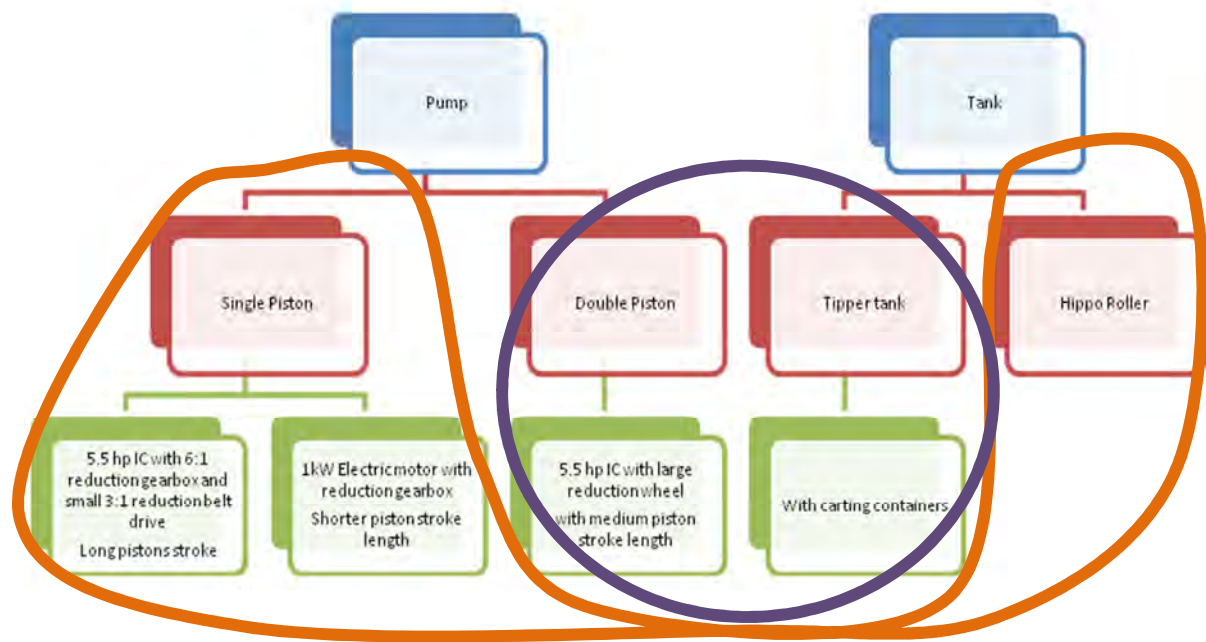

Figure 6.11 Simpler design option suitable for entrepreneurs (purple) and more complex design options suitable for municipality (orange)

6.3 Recommendations for further development

A number of activities are suggested for further work on the NanoVac:

- Investigate methods to macerate waste prior to vacuuming (a brush cutter was tested without success, as it does not have enough power)
- Fit handles to the NanoVac frame to aid transport (Figure 6.12)
- Stiffen the frame to minimise movement during operation
- Develop a more robust piston arrangement, probably using steel instead of PVC

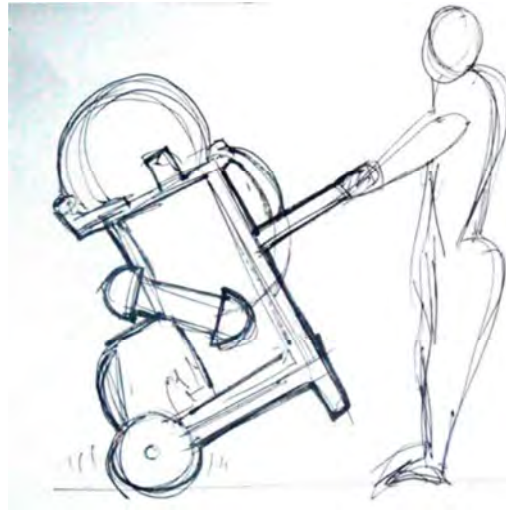

Figure 6.12 Sketch of Nano Vac with handles

It has also been suggested that blowing waste out of the pit may be possible. Therefore testing with both the blowing and sucking hoses in the pit may be interesting to see if the blowing air can help to suck the waste out.

7 THE EVAC

The eVac was developed on the same principle as the NanoVac: a vacuum is created in a container which in turn sucks up sludge from a pit. However a vane pump was used rather than a piston pump. The pump and a 1.5 kW electric motor, powered by a generator, were mounted on a custom fabricated steel trolley and connected by a belt drive. The oil supply for the pump was mounted above it, as were the vacuum relief valve and the moisture trap. A float valve, made from a squash ball, closed the vacuum line when the container was full in order to prevent sludge from being sucked into the pump. Despite the trolley unit weighing a total of 63 kg the trolley was manoeuvrable, was capable of being moved easily across rough ground and could be lifted onto a vehicle by two people. The trolley was also stable when standing upright because the pump and motor were mounted low down on the trolley. A manual for the manufacturing and operation of the eVac can be found on the Partners in Development website (www.pid.co.za).

7.1 Prototype development

The e Vac was designed and developed to meet the criteria that it must be:

- simple to use
- light enough to be transported to the work site on an ordinary pick-up truck
- light enough for two people to transport on site over rough ground without great effort
- affordable for use in a pit latrine emptying project
- adequately versatile to remove a range of sludges (including those containing some rubbish) from a range of pit latrines
- designed to minimise the risk of workers coming into contact with sludge and of contamination of the work environment by sludge
- possible to manufacture and maintain using parts and skills that are locally available in a developing country



Figure 7.1 The eVac

7.1.1 Motor

The e Vac was powered by a 1.5 kW (2HP) single phase electric motor with an attached control box. A short 2.5 mm power cable was used in order to prevent catching on objects, which was used with a separate extension cord. The motor required a standard 230V power source and for this a generator could be used if a nearby power source was not available. A petrol engine could have been used to overcome the need for a power source, but this would have made the eVac less manageable and more susceptible to damage. A governor would have been needed to ensure that the pump would turn at a fairly constant rate.

7.1.2 Pump

The e Vac used a small oil lubricated vane pump sourced from a dairy equipment supplier. It could produce an air flow of 300ℓ/min at 0.5 bar vacuum. The exhaust of the pump was used to provide positive pressure to expel the contents from the pressure vessel. While this was a useful function, there was significant oil carryover into the exhaust air flow, which reached high temperatures.



Figure 7.2 The components of the vane pump (the stator on the left, and rotor with removable vanes on the right)

A vane pump is designed to pump air only. Any sludge, solids, or even significant amounts of liquid entering the pump are likely to damage the moving parts. Two float valves and a moisture trap protected the pump from the possible entry of sludge. The primary float valve was attached to the lid of the sludge collection container. A squash ball was found to be heavy enough not to be sucked upwards by the air stream as well as elastic and ductile enough to block the vacuum. The ball was contained in a short length of PVC pipe over the vacuum outlet. As sludge filled the tank it lifted the float. If the float reached the level of vacuum outlet it blocked the vacuum line, preventing sludge from continuing to be sucked into the tank to the point of overflow. While the float valve was effective, it was still possible that liquid sludge in the tank could splash up and enter the pump without the float valve closing.

As a moisture trap could not be sourced locally, one was custom made using a 320 mm length of clear 140 mm diameter PVC pipe with two end caps. Sludge escaping past the float valve entered this container through a hole in the lid. Gravity prevented sludge from exiting through the suction line. In the event that the container filled with liquid a second float valve would block the suction line. However, a brass one-way valve at the bottom of the trap allowed the contents of the trap to drain under gravity every time vacuum pressure was released. While this protected the pump, it introduced the possibility of contaminating the ground under the moisture trap. A container was therefore needed to collect any sludge draining from the moisture trap.



Figure 7.3 Moisture trap

7.1.3 Pressure vessel

A fibre glass pressure vessel was initially designed with a capacity of 100 litres. The size of the tank was increased to 180 litres, but the tank was not strong enough to withstand the vacuum produced by the eVac and it imploded. More fibreglass was added to increase the thickness of the walls.

The tank was reinforced with steel hoops and a large bore suction pipe was connected to the sludge inlet point at the top of the tank to suck sludge from the pit, allowing the tank to be filled to maximum capacity and reducing the risk of sludge splashing into the suction hose. Sludge was discharged from the outlet at the bottom of the tank into a layflat pipe. A pressure gauge indicated the pressure in the tank. An attempt was made to make a pressure relief valve using a design provided by Manus Coffey. This proved to be more difficult than anticipated as it was difficult to prevent the valve leaking air at low pressures. Ultimately, a standard pressure relief valve was used.



Figure 7.4 A custom made 180 litre fibreglass tank which imploded under vacuum pressure

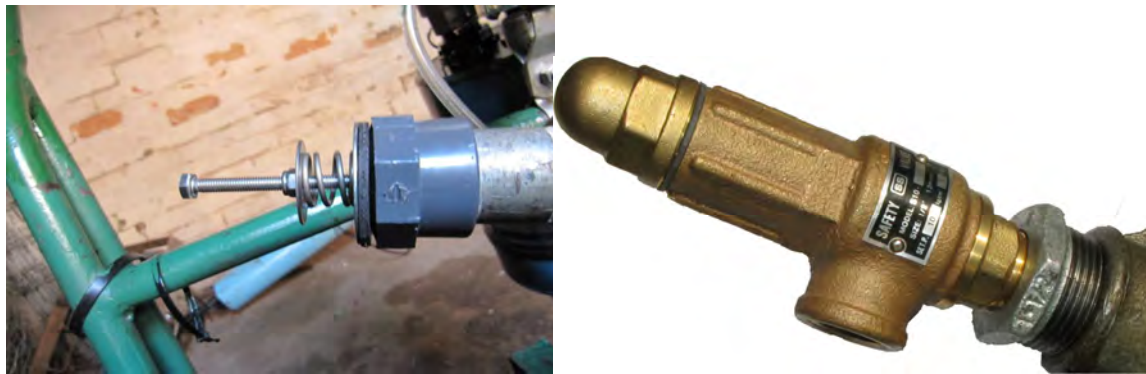

Figure 7.5 A pressure relief valve based on a design drafted by Manus Coffey (left); a standard pressure relief valve (right)

While this vessel was relatively light, its size made it awkward to move. In addition, it took time to develop a vacuum within it, which meant that the plug and gulp method could not be used. It proved difficult to source a smaller tank able to withstand a vacuum. While roto-moulding is relatively expensive when a small quantity of containers is required, a roto-moulder was found with an existing mould of approximately the correct dimensions and containers with a 47ℓ capacity were made using Linear Low Density Polyethylene (LLDPE). These were 770 mm high with a 310 mm diameter. A wall thickness of 7 mm in the initial design proved inadequate to withstand the vacuum and the walls imploded. The design was revised to use 14 mm walls. Each container weighed 9.6 kg. These vessels were easier to manoeuvre and also allowed the waste to be extracted by “plug and gulp”, where the hose is thrust in and out of the sludge. Using a smaller container meant that less time was required to form a vacuum, and the time between gulps was therefore reduced. Handles were added to the containers to make them easier to carry. These were short lengths of webbing held in place by very large diameter pipe clamps.



Figure 7.6 7 mm thick vessel imploded under vacuum (left) and 14 mm thick vessel currently in use with carrying straps (right)

Two types of lids were designed to facilitate two alternatives for emptying the vessel: the “suck only” arrangement, in which sludge is sucked in to the vessel and then tipped out of the vessel into a disposal pit, and the “suck and blow” arrangement, where sludge is sucked into the vessel and then expelled through a second hose.

“Suck only” arrangement

For this method an interchangeable lid, with the air and sludge lines attached, was used with multiple vessels. Once one vessel was filled the lid was moved to an empty vessel and the full vessel was emptied by tipping into a disposal pit. The lid was made of 8 mm steel plate with a thinner steel shim around the edge to enable it to sit well on the vessel. There was no attachment to the container, and the lid stayed on by the force of the vacuum alone. A foam rubber strip on the underside of the lid improved the seal. The lid weighed 9.6 kg. It would be possible to reduce the weight by using a thinner steel plate, as 8 mm is quite conservative.

The air line was connected to a 1” T piece attached to the lid. The other outlet from the T was connected to a ball valve which, when open, released the vacuum in the container. Both of these connections were initially screwed on, but these tended to work loose in testing and so were welded in place. As the sludge hose collapsed during testing near the connection to the lid, a 3” steel elbow was added to the lid.

Attached to the inside of the lid beneath the air line is the primary float valve. This is attached by a long plastic nipple which screws in to the underside of the T.



Figure 7.7 The sludge hose collapsed near the point of connection during testing (left); the “suck only” lid with steel elbow for connection to sludge hose (right)

“Suck and blow” arrangement

When working with the eVac in the suck and blow configuration, only one container was used. Rather than have an interchangeable lid which was moved between containers the lid was bolted onto the container, only to be removed for maintenance or in exceptional circumstances. This allowed the container to withstand positive pressure as well as a vacuum.

The container required two air hoses: one for vacuum and one for pressure. These hoses both passed through three-way valves before entering the container. On each of the valves one side was linked to the atmosphere and the other to a steel “T” which joins the container.

The sludge inlet pipe and sludge outlet pipe both required valves that allowed them to be closed to prevent sludge from being sucked or blown through the wrong pipe. Duckbill valves – one way valves which would not get blocked easily – would have been ideal for this but could not be sourced locally, and as a result ball valves were used which must be opened and closed manually. The sludge inlet pipe was connected to the lid, while the sludge outlet layflat pipe was connected through an attachment at the bottom of the container.

The total weight of the container is 27 kg, meaning that it could be carried by one person. As it did not need to be moved once in position its weight did not pose a problem.



Figure 7.8 The “suck and blow” vessel

7.1.4 Hoses and fittings

Flexible hoses approximately 3 m long were used to carry air. One inch diameter hose was used throughout to simplify sourcing of parts for manufacture and maintenance.

A five metre 3” flexible ‘heliflex’ hose was used for sludge. The hose connected to the container lid using a 3” camlock coupling which provided a good seal but could be difficult to operate if it was soiled. A plastic bushing reduced the diameter of the entry point of the hose in order to prevent objects large enough to cause a blockage from entering the hose. A stainless steel pole was attached to the hose to aid control of the hose while manoeuvring it in the pit. This was later removed as it was too short to reach the bottom of the pit and it could not be lengthened without becoming too long to enter the superstructure of a pit. While a modular pole could be designed to be assembled inside the structure, disassembling it after use would expose the operator to sludge and result in a number of contaminated parts having to be transported.

Camlock couplings were used throughout as they are easily sourced in South Africa. Each hose has a male coupling on one end and a female coupling on the other. Arrangements on the machines and tanks were designed to ensure that hoses would not be connected incorrectly. The couplings also allowed hoses to be joined together if a longer hose was needed.

Hoses were not mounted on the trolley for storage as this would have created a risk of contaminating the machine if the hoses were soiled. It would also have made the machine much more unwieldy to start and move.

7.1.5 Air and water lance

An air and water lance was tested to loosen and fluidise dry sludge in order to assist extraction. An air compressor was tested with the lance, but simply attaching the exhaust of the eVac to a 3 m long 15 mm diameter hollow stainless steel pole proved equally effective. A fibreglass tank was added to the air lance to enable it to inject water as well. A combination of water and air was also tested. In testing, the addition of air or water was not found to aid extraction significantly unless large amounts of water was added, which is impractical.



Figure 7.9 Air/water lance

7.2 Testing

The e Vac was first tested on pig slurry using the “plug and gulp” technique. The tank filled in less than 30 seconds, with one blockage from a rubbish bag. The pressure vessel was able to achieve a pressure of -0.2bar. However, once the water level rose above the inlet the suction efficiency decreased. When the vacuum was released to empty the tank the lay flat pipe started to fill with water prematurely. A clip rather than valve should be used to close off the lay flat pipe when releasing the vacuum. It is important to position the tank carefully on site before filling it, as it is extremely heavy once full and cannot easily be moved.

“Suck only” method

In a test on a VIP pit with dry sludge, it proved very difficult to remove the dense material with the eVac. The air/water lance was used to add a small amount of water to a specific area of the pit. This fluidized the sludge enough for the e Vac to lift it but progress was very slow. Injecting air alone did not make the sludge easier to remove.



Figure 7.10 eVac emptying a pit using multiple pressure vessels with carrying handles

The eVac was then tested on two pits with wetter sludge – one a low flush pit and the other a VIP with relatively liquid contents. No difficulties were encountered emptying the low flush pit and the 40 litre containers filled in less than 10 seconds. The critical factor in determining the speed of the emptying cycle was the time it took to walk with the containers to the disposal pit and back. For the VIP pit, most containers filled in around 10-15 seconds, although some took longer. There was a moderate level of rubbish in the latrine but despite this the sludge pipe only blocked once.

With only two labourers, the total cycle time for filling and emptying the container was close to a minute: with another labourer this could have been significantly faster.

It was found that significant splashing and spilling occurred, contaminating the area around the pit, during the removal of the wetter sludge. There was also a risk of spilling the liquid contents of the containers as they were carried to the disposal pit (which in one case required walking through a vegetable patch).



Figure 7.11 Emptying a pit with the eVac

“Suck and blow” method

The suck and blow tank was tested on a low flush soak pit and the vessels were found to fill even more quickly than in the trial with the suck only tank. This could be attributed to the volume of sludge at the bottom of the tank which was not emptied out at the end of the cycle and the sludge inlet pipe remaining largely full between cycles. Blowing the waste into the disposal pit also proved efficient, as did switching the valves between suck and blow. The total time including setting up, emptying and packing away was approximately 45 minutes. Three labourers were used: one to control the sludge intake, one to operate the valves on the tank, and one to control the sludge outlet. One attempt was made to use the “suck and blow” method to empty a VIP pit. The eVac was unable to suck any substantial amount of material from the pit, despite being able to build up high vacuum pressures using the “plug and gulp” method. This appeared to be due to the substantial rubbish content of the pit.

7.3 Evaluation

The eVac proved an effective and efficient technology for emptying pits which contain a fairly liquid sludge with a limited amount of rubbish. The eVac was easy to move from site to site and on site and proved stable as the components are mounted low on a trolley.

Manufacturing the eVac would cost between 18,000 and 22,000 ZAR (US \$2,200-\$2,700), which makes it affordable in the scope of a pit latrine emptying project. A cost estimate using 2011 prices for parts sourced in South Africa and including VAT is provided in Table 7.1. The cost of a generator and a vehicle to transport it, should these be necessary, are not included. The cost includes three containers for the suck only eVac, and the one container for the suck and blow eVac. Twenty hours assembly time has been allowed for, at the rate of R50/hour.

The trolley unit would be cheaper if greater numbers were being made, and discounts could be achieved on other parts as well. These costs are based on the prices paid for parts for the prototype unit.

Table 7.1 Estimated cost to build an e Vac

	Suck Only		Suck & Blow	
Pump	R	7,353	R	7,353
Motor	R	2,000	R	2,000
Main Unit	R	3,212	R	4,018
Moisture trap	R	706	R	706
Containers	R	3,181	R	5,357
Hoses	R	851	R	1,254
Assembly	R	1,000	R	1,000
Sum	R	18,303	R	21,688
	\$	2,288	\$	2,711
	£	1,525	£	1,807

7.4 Recommendations

Further testing of the eVac is needed. In addition, the following considerations are recommended for further design development or for production.

- Further development of the moisture trap is needed to prevent sludge released from the trap from draining onto the ground. If a separate container is used for this purpose it is likely to be forgotten and will then be an additional item which must be emptied, transported safely and cleaned.
- The electric control box is vulnerable during rough handling. This may be remedied by welding on some metal bars around the control box as a roll cage or by using a steel control box.
- The vane pump uses a large amount of oil, probably because of the low vacuum pressures it runs at most of the time. Additionally, the oil container tends to leak when in transit, if not kept upright, and is susceptible to the inevitable knocks it receives. It may be desirable in future to have an oil-free vane pump, or to use a liquid ring vacuum pump.
- The pressure and vacuum gauges could be eliminated from a production model. It is possible to tell whether the pump is generating a significant vacuum by the noise it is making.
- The pressure relief and vacuum relief valves could be eliminated from a production model. The vacuum relief valve is unnecessary because all of the components can withstand the maximum vacuum pressure that the vane pump can create. The pressure relief valve is unnecessary as the tank leaks slightly at around 2 bar, meaning that the pressure cannot rise above this.
- A lighter steel could be trialled for the “suck only” lid to reduce the weight of the lid.
- The dimensions of the “suck and blow” container are not ideal for the number of pipes required. If the top of the container were larger there would be space to put both of the 3” pipes on the lid which would be a simpler design.

- The suck and blow tank requires 4 valves to be adjusted to switch from sucking to blowing and vice versa. Although this is not a difficult task and no damage will occur if operated incorrectly it is an area where confusion could occur and potential operational problems could arise. The current setup of the tank means that the 3-way air valves tended to rotate as they were used. A more robust setup, probably by welding the system to the lid, would be a better long-term solution. During development the flexibility in being able to change the setup is useful, however.

8 CONCLUSIONS

This research project has provided a valuable opportunity to explore methods to aid the evacuation of pit latrines. Work focused on four pit emptying technologies, or PETs: the Gobbler, based on a chain and scoop concept; the Pit Sludge Auger (PSA), based on an auger concept; the NanoVac, a vacuum pump which uses pistons to create the vacuum; and the eVac, which uses a commercially available vane pump.

The **Gobbler** proved to be heavy and awkward to manoeuvre. Moreover, it was not particularly successful when operating in sludge, jamming easily. Development work on the Gobbler was therefore stopped at an early stage.

The **Pit Sludge Auger** (PSA), though also heavy and awkward, proved more successful. The PSA was able to lift a thick pig slurry at a rate of 25 litres per minute. However, when the PSA was tested on an actual pit latrine in the field it was not successful, possibly due to the trash content. A problem with an auger based evacuation method is that if the sludge is too dry it does not flow towards the auger intake, making the process slow and inefficient.

The **NanoVac** worked well on the wetter type of sludges produced by low flush latrines and pour flush latrines, but was never tested on a dryer VIP latrine. If further development work was done on this machine the focus should be on making it more robust, particularly in the design of the pistons, where the low cost PVC option used for this project was found to break too easily.

The **eVac** was the most successful of the PET technologies developed under this project. It was able to evacuate the sludge from low flush or pour flush latrines without difficulty, and also had no trouble with the sludge from a number of wetter pit latrines. However, when it was tested on dryer pit latrine sludge it was not very successful. In such cases vacuum pumping requires the continuous addition of water and the mixing of the sludge, and a more powerful vacuum pump.

Pit emptying requires a range of tools and the eVac or NanoVac would be useful additions to the pit emptier's toolkit.

While focusing on pit emptying, sight should not be lost of other solutions to the problem of full pits, which include the following:

- Use of urine diversion toilets with small vaults that are easily accessed and manually emptied
- Use of pour flush toilets with offset alternating pits of a manageable size which are easily accessed and manually emptied
- Use of small pits which are frequently emptied before the sludge becomes too dense
- Use of large pits (3.5 m³ to 4.5 m³) which if not also used as rubbish disposal pits can last for 20 years and more, and which are abandoned when full
- Use of prefabricated lightweight toilets which are designed to be moved when the pit is full

REFERENCES

Coffey, M (2011) Presentation to the first Faecal Sludge Management seminar FSM1, Durban, 2011

Radford, J. (2011) *Fluidisation of synthetic pit latrine sludge*, Final year research report, Cambridge University

Muller, M.S. and Rijnsburger, J. (1992): *MAPET. A neighbourhood based pit emptying service with locally manufactured hand pump equipment in Dar es Salaam, Tanzania*. Gouda.

WASTE. MAPET in narrow street in Tanzania . [Online] akvo. [Cited: April 14 , 2009.]

Appendix A: Specifications for Pit Screw Auger

Component	Details
Motor	1.1 kW electric motor, with controls to allow for both forward and reverse movement
Gearbox	1:70 reduction
Drive	Chain and sprocket
Screw	100 mm diameter, 100 mm pitch, 1.5 m long
Casing	125 mm diameter PVC pipe
Support	Custom steel support with 4 chains, to connect to a tripod
Discharge	135 degree 125 mm diameter connection piece. Reverse screw inside to force sludge out
Intake cage	Optional

❖ Safety

When dealing with human waste, it is vital that the proper health and safety procedures are followed. When using the PSA, the proper protective gear must be worn at all times. This includes; eye protection, durable water proof gloves, face mask, appropriate overalls, and sturdy covered shoes. Lifting the PSA is a two man job and should never be attempted alone. The discharge bucket should also only be lifted by two men. Care must be taken at all times that the operators do not come into contact with the human waste.

❖ Maintenance

The following maintenance procedures should be followed:

- Keep the gearing and bearing lubricated.
- Clean regularly after each use. Remove the PVC pipe and spray down the screw with water and a brush. Use appropriate disinfectant.
- Store the PSA in a dry secure location.

Operational Flow Chart

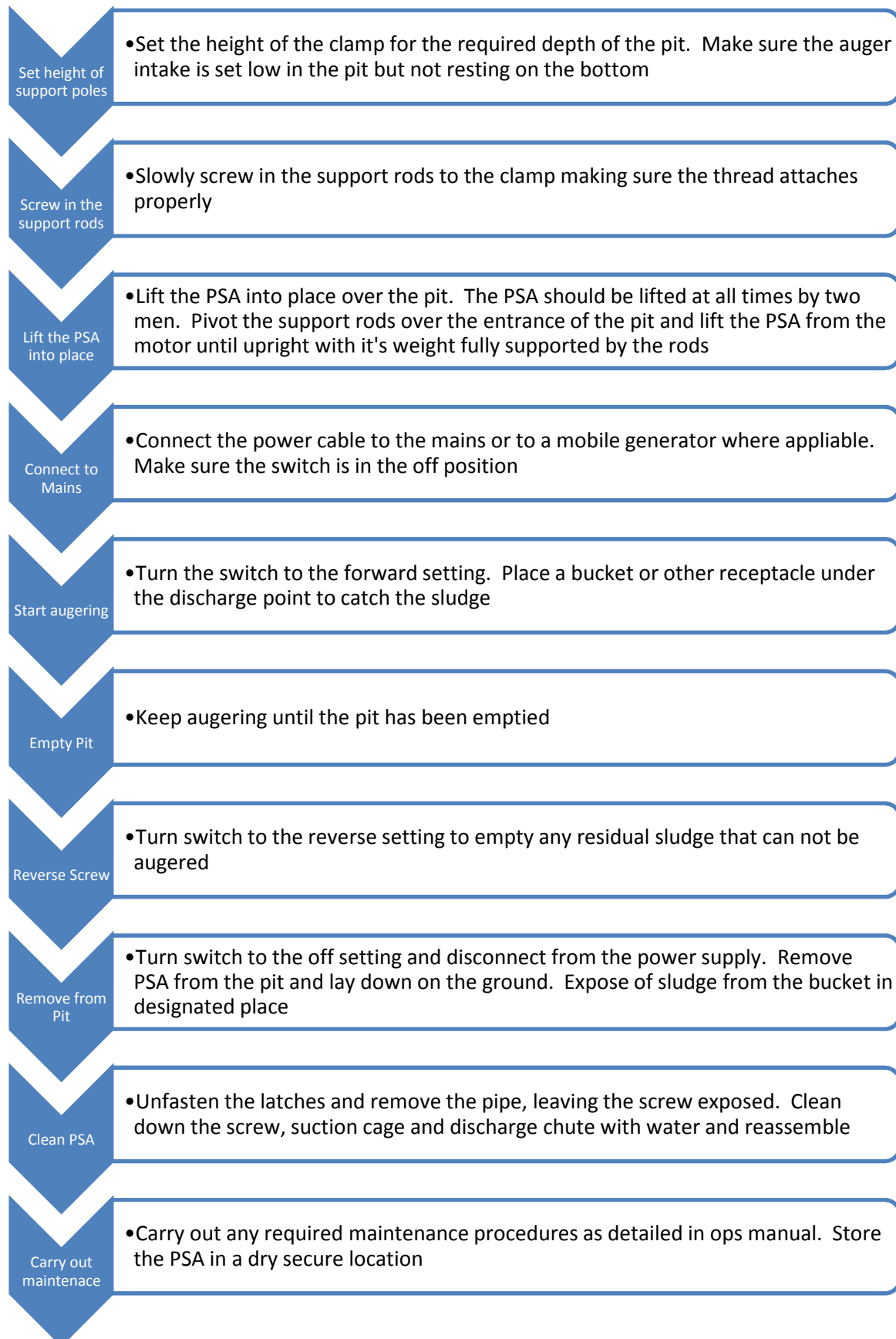

Appendix B: Specifications for eVac

Part	Specification	Notes
Motor	1.1 kW electric motor	Powered by a generator or on-site electricity
Pump	Vane pump, (300ℓ/min at 0.5 bar vacuum), supplied by DeLaval Belt driven Oil lubricated	Can be used for both suction and pressure (Fig 2)
Vacuum release valve	Supplied by DeLaval	Can be used to prevent excessive vacuum in the containers (Fig 4)
Moisture Trap	140 mm diameter, 320 mm high Clear PVC pipe with end caps Float valve can block the suction line Brass check valve allows the trap to empty automatically when suction released	Placed on suction hose before the pump. Prevents moisture entering the pump. (Fig 3)
Air Hose	1" 3 hoses of between 1 and 3 metres	Contain vacuum between the pump and container, and carry pressurized air between the pump and the air lance
Sludge Hose	3" x 3 m long	Has a pole attached to the end so that it can be manoeuvred inside the pit, and a plastic bushing at the end to narrow the end to prevent material from entering the pipe which could block it.
Fittings	Cam Lock 1" fittings for the air hose and Cam Lock 3" fittings for the sludge hose	Would consider using alternative fittings for sludge hose as cam Locks are difficult to operate when dirty.
Containers	47ℓ LLDPE custom roto-moulded, with an open top Diameter: 310 mm Height: 770 mm Thickness: 15 mm	Currently 3 are used, allowing the emptying to continue whilst one of the containers is being emptied. The container is very thick as a thinner model could not withstand the vacuum required. Tested to a vacuum of 0.8 bar.
Container Lid	8 mm steel. Suction hose has a float valve to close it when tank is full Silicone sealant used on underside to create good seal with containers	Interchangeable self-sealing lid can be moved quickly between containers A thinner steel could probably be used
Trolley	Painted steel, with motor, pump, vacuum release valve and moisture trap mounted to it	
Air Lance	3 m long 15 mm diameter stainless steel pole	Used for loosening material in pit

A full operations manual for the eVac is available from Partners in Development on request.



Fig 1 – eVac motor



Fig 2 – eVac pump



Fig 3 – eVac moisture trap



Fig 4 – eVac vacuum release valve and oil reservoir