

Construction of ecological sanitation latrine



This handbook is the outcome of the ecological sanitation latrine promotion projects carried out by WaterAid's partners in Nepal : the Environment and Public Health Organisation, Lumanti Support Group for Shelter and Centre for Integrated Urban Development. The experiences of agencies like the Department of Water Supply and Sewerage, UN-HABITAT, World Health Organisation and D-Net have also been instrumental in developing this handbook.

This document sets out the principles for adopting an ecological sanitation approach, as well as providing guidance on the construction ecological sanitation latrines and their operation. It is intended to support sanitation field practitioners and WaterAid in Nepal 's partners in the delivery of appropriate services and technologies to fit the needs of different users. .It is also equally hoped that this document will be of value to other organisations and sector stakeholders involved in sanitation promotion and ecological sanitation.

The production of this document was led by Kabir Das Rajbhandari from WaterAid in Nepal . Colleagues from the Advocacy team in Nepal reviewed the document, providing valuable input.

This document should be cited as WaterAid in Nepal (2011) *Technical handbook - Construction of ecological sanitation latrine.*

The document can be found in the documents section of the WaterAid in Nepal country programme website– www.nepal.wateraid.org

A WaterAid in Nepal publication

September 2011



WaterAid transforms lives by improving access to safe water, hygiene and sanitation in the world's poorest communities. We work with partners and influence decision makers to maximise our impact.

Cover picture:

Top : Buddhi Sipai: A farmer from Layku, Thimee, Nepal front to his ECOSAN Latrine.

Middle : Gyani Maya Maharjan from Siddhipur, Lalitpur Nepal at her composting latrine near to her kitchen garden.
WaterAid/Marco Betti

Bottom: Chandrawati Maharjan from Gamcha, Kirtipur, Nepal puring ass at her ECOSAN latrine after use of the latrine.
WaterAid/Anita Pradhan

Contents

Abbreviation	iii
1 Introduction	1
1.1 Background	1
1.2 What is ECOSAN?	1
1.3 Why ECOSAN	2
1.3.1 ECOSAN - a new paradigm	2
1.3.2 Inadequacy of current options	3
1.3.3 Merits of ECOSAN	4
1.3.4 Requirements for sustainable ECOSAN systems	5
1.4 Why this manual?	5
2 Planning for ECOSAN latrines	7
2.1 Knowledge management on ECOSAN	7
2.2 Planning of ECOSAN	8
2.3 Foundation of planning for ECOSAN latrines	8
3 Technology, design and management	11
3.1 Factors influencing design and management	12
3.2 Dealing with faeces	12
3.3 Dealing with liquids	14
3.4 Preventing odors and flies	17
3.5 Household management: removal and treatment	18
3.6 Technical options	18
3.7 Maintenance	20
3.8 General hygienic aspects of ECOSAN latrines	21
3.9 Technological aspects	22
3.9.1 Urine Diversion (UD) latrines	23
3.9.2 UD Dehydration (Dry ECOSAN) latrines	24

3.9.3. Wet ECOSAN (Twin Pit Pour Flush) latrines	28
3.9.4. Composting latrines	31
4 Implementation and construction	33
4.1 Software components for promoting ECOSAN latrines	33
4.1.1 Preparatory stage of implementation	33
4.1.2 Socio-cultural aspects of ECOSAN	35
4.1.3 Addressing gender issues	37
4.1.4 Financial aspects	38
4.1.5 Role of different stakeholders in promoting ECOSAN latrines	40
4.2 Hardware components for implementation and construction	40
4.2.1 Components of ECOSAN latrine	40
4.2.2 Types of ECOSAN latrines	42
4.2.3 Construction details and other important information	45
4.2.4 Guidelines for construction	46
4.2.5 Quantity estimation for an ECOSAN latrine	48
5 Common problems and trouble shooting; potential problems and constraints; dos and don'ts	51
5.1 Common problems and trouble shooting	51
5.2 Problems and constraints	52
5.3 Dos and don'ts with ECOSAN latrines	52
6 References	55
Annexes	
Annex :1 - Sample drawings of ECOSAN latrines	57
Annex: 2a - Comparison of cost between ECOSAN and other latrines	59
Annex: 2b - Materials for double vault dry ECOSAN latrine up to pan level	60

Abbreviation

C:N	-	Ratio of Carbon and Nitrogen
cm	-	Centimeter
CT	-	Composting Toilet
DS	-	Dry Sanitation
DT	-	Dry Toilet
ECOSAN	-	Ecological Sanitation
ENPHO	-	Environment and Public Health Organisation
GTZ	-	German Cooperation
HCES	-	Household Centred Environmental Sanitation
JMP	-	Joint Monitoring Programme
MDG	-	Millennium Development Goal
mm	-	Millimeter
PCC	-	Plain Cement Concrete
PVC	-	Poly Vinyl Chloride
RBT	-	Reed Bed Treatment
SWOT	-	Strength, Weakness, Opportunity and Threat
UD	-	Urine Diversion
UDD	-	Urine Diversion Dehydration
UDDT	-	Urine Diversion Dehydration Toilet
UNICEF	-	United Nation's Children Fund
WHO	-	World Health Organisation
WSSCC	-	Water Supply and Sanitation Collaborative Council



Introduction

1.1 Background

The current global trend of urbanization is creating a pressure on Nepal's eco-system. Nepal is struggling with the most rapid urbanization trend in the South Asian Sub-continent with approximately 15% of its total population living in 58 designated urban areas. This is expected to reach 23% by 2016 as the urban population is increasing at 6.6% per annum reflecting both an increase in migration to towns as an escape from rural poverty, conflict and the reclassification of emerging towns from villages to municipalities.

The present sanitation situation in Nepal indicates the coverage only about 46% of total population with access to some kind of latrine facilities. The scale of the problem is further illustrated by the present achievement made by the country to meet Millennium Development Goal (MDG) targets. The toilets constructed in some parts of the country are often failed to meet the required level of hygiene. The challenge at present is to increase the toilet coverage and its accessibility by increasing the depth of understanding of community to ensure usage and sustained behaviour. In all the circumstances, the toilet must be hygienic, safe and environmentally friendly and affordable.

Figure 1:
ECOSAN - Closing the sanitation loop



Source: ENPHO

1.2 What is ECOSAN?

Ecological Sanitation (ECOSAN) is an environment friendly sustainable sanitation system which regards human waste as resource for agricultural purposes and food security. In contrast to the common practice of linear waste management which views waste or excreta as something that needs to be disposed, ECOSAN seeks to close the loop of nutrients cycle, conserve water and our surrounding environment.

The basic principle of ECOSAN is to close the loop between sanitation and agriculture without compromising health and is based on the following three fundamental principles:

- a. Preventing pollution rather than attempting to control it after we pollute
- b. Sanitizing the urine and faeces
- c. Using the safe products for agricultural purposes

The goal of closing the nutrient and water cycles is need to be fulfilled on a large scale to render current sanitation practices an eco-friendly one. However, it is generally agreed that it is wise to reuse nutrients and save resources. The ECOSAN toilet technology fulfils this aim and provides effective alternative solutions, with or without water, because this technology can be viewed as a three step process dealing with human excreta i.e. containment, sanitization (treatment) and recycling.

Basic principles of ECOSAN Latrine:

- ◆ Offers a safe sanitation solution that prevents disease and promotes health by successfully and hygienically removing pathogen-rich excreta from the immediate environment.
- ◆ Environmentally sound as it doesn't contaminate groundwater or save scarce water resources.
- ◆ Recovers and recycles the nutrients from the excreta and thus creates a valuable resource to reduce the need for artificial fertilizers in agriculture from what is usually regarded as a waste product.

1.3 Why ECOSAN?

1.3.1 ECOSAN – a new paradigm

This approach, mostly addressed as “ecological sanitation” or ECOSAN offers an alternative to conventional sanitation. It is based on an overall view of material flows as part of an ecologically and economically sustainable sanitation system tailored to the needs of the users and to specific local conditions. It does not favour or promote a specific sanitation technology, but is rather a new philosophy in handling substances that have so far been seen merely as wastewater and water carried waste for disposal. It carries with it a new approach to sanitation education, a new discourse, and a new way of managing knowledge.

ECOSAN is new paradigm in sanitation as it is based on ecosystem approaches and the closure of material flow cycles rather than on linear, expensive and energy intensive end-of-pipe technologies. ECOSAN systems are part of several cycles, of which the most important cycles are the pathogen-, water-, nutrient- and energy cycle. It recognizes human excreta and water from households not as a waste but as a resource that could be made available for reuse, especially considering that human excreta and manure from husbandry play an essential role in building healthy soils and are providing valuable nutrients for plants.

WaterAid Nepal, in 2002, promoted ENPHO for the first time to introduce ECOSAN toilet in Nepal.

Figure 2:
Drop-and-Store

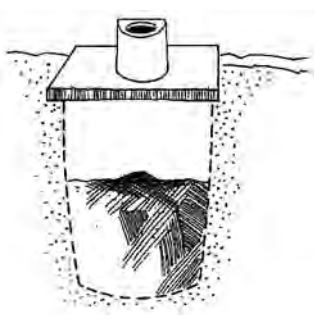
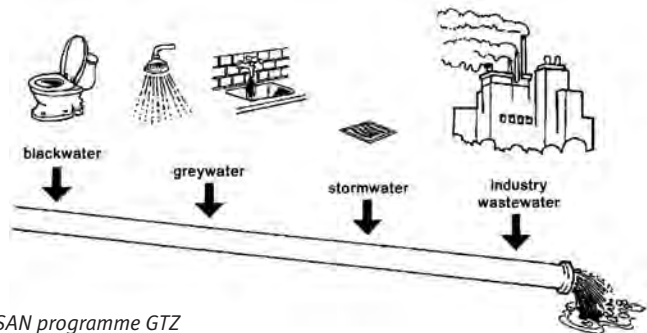

Figure 3:
Flush-and-Discharge



Source: ECOSAN programme GTZ

ECOSAN systems restore a remarkable natural balance between the quantity of nutrients excreted by one person in one year and that required to produce their food (7.5 kg nitrate, phosphorous and potassium to produce 250 kg of grain) and therefore can greatly help in saving limited resources. ECOSAN does not favour a particular technology but is rather a philosophy in recycling oriented resource management and offers modern, convenient, gender friendly and desirable solutions, in accordance with the Bellagio Principles as formulated by the Water Supply and Sanitation Collaborative Council (SANDEC/WSSCC 2000a).

1.3.2 Inadequacy of current options

The sanitation practices promoted today are either based on hiding human excreta in deep pits ('drop-and-store') or on flushing them away and diluting them in rivers, lakes and the sea ('flush-and discharge').

Drop-and-store systems can be simple and relatively low-cost but have many drawbacks. Often they cannot be used at all in crowded areas, on rocky ground,

where the groundwater level is high or in areas periodically flooded. They require access to open ground and the digging of new pits every few years.

Flush-and-discharge systems require large amounts of water for flushing, and for many municipalities couldn't afford investments in pipe networks and treatment plants. Over a year for each person some 400-500 litres of urine and 50 litres of faeces are flushed away with 15,000 litres of pure water. Water from bath, kitchen and laundry may add up to another 15,000-30,000 litres for each person.

The problems people normally face from the conventional sanitation system are:

- ◆ They are not working properly at all and do not ensure safe and healthy sanitation but increase health risks from severe water pollution due to On-Site Sanitation systems
- ◆ No recycling of water and nutrients leading to **Loss of valuable nutrients** for agriculture
- ◆ Are largely linear end-of-pipe technology systems where drinking

water is misused to transport waste into the water cycle, causing environmental damage and hygienic hazards, and contributing to the water crisis.

- ◆ Unsatisfactory purification or **uncontrolled discharge** of more than 90 % of wastewater worldwide
- ◆ Consumption of **precious water for transport of waste**
- ◆ Frequent **neglect of poorer settlements**

Further down the pipe rainwater from streets and rooftops and wastewater from industries are often added. Thus at each step in the flush-and-discharge process the problem is magnified: the really dangerous component, the 50 litres of faeces, is allowed to contaminate not only the relatively harmless urine but also the huge amount of pure water used for flushing and an equal or even larger amount of grey water.

1.3.3 Merits of ECOSAN

Ironically, more water is being wasted for flushing toilets than its use for drinking. Conventional sanitation facility is intricate in terms of commission and operation. It harbours many loopholes. It adds more wastewater than manageable. Rivers and ponds now are merely open sewer for most period of the year. Therefore, there is a need to revive the concept of ECOSAN so as to fully recognize and utilize the value of excreta. The demand of ECOSAN latrines, based on the literatures, can be said to be fuelled by:

- ◆ Declining fertility of land
- ◆ Increased cost of artificial fertilizer, and related poverty
- ◆ High number of subsistence farmers in the urban and peri-urban areas



Source: ECOSAN programme GTZ

- ◆ Minimum usage of water
- ◆ Possibilities of ground water contamination reduced

Besides, ECOSAN latrine, a hygienic sanitation option, prevents pollution, fights infections, saves water, promotes zero waste management and encourages food production. In addition, it helps:

- ◆ Promotion of recycling
- ◆ Conservation of resources and contribution to the preservation of soil fertility
- ◆ Improvement of agricultural productivity and hence contributes to food security
- ◆ Increasing user comfort/security, in particular for women and girls Promotion of a holistic, interdisciplinary approach.
- ◆ Cyclic Material-flow instead of disposal.
- ◆ ECOSAN stands for turning waste into a useful and marketable resource

- ◆ **A human being almost produces the amount of nutrients that is needed for growing his/her food:**
- ◆ **Urine (very few pathogens): 88% of the nitrogen, 67% of the phosphorus and 71% of the potassium carried in domestic wastewater**
- ◆ **Faeces contain 12% of the nitrogen, 33% of the phosphorus, 29% of the potassium and also 46% of the organic carbon – but highly pathogenic.**

1.3.4 Requirements for sustainable ECOSAN systems

The ECOSAN Toilet System should be:

- ◆ Compatible with the socio-cultural and economic conditions of the target area
- ◆ Comprehensible to the users
- ◆ Simple, robust and easy to operate and maintain and should exploit locally available resources
- ◆ Protect the environment by isolating or destroying the faecal pathogens

1.4 Why this manual?

The concept of Ecological Sanitation (ECOSAN) is getting popular gradually particularly in peri-urban context of Nepal and this technology is gradually being promoted in rural areas as well. The evidence of this gradual scaling up of this ECOSAN technology is the increasing number of ECOSAN Latrines in Nepal and the growing interest of the people in this technology. Considering the gradual promotion of ECOSAN latrines and its potential of wider application and scaling up by different actors like DWSS, WaterAid, Practical Action, UN-HABITAT, ENPHO, Lumanti, DNet etc., there is a growing need for an operational manual for the people involved in this discipline to assist them in establishing or promoting

ECOSAN latrines thus ensuring the quality control over the construction.

This manual is designed for professionals, and practitioners who are interested in promoting ECOSAN in Nepal and might be useful for other developing countries for the purpose mentioned. The manual briefly explains the basic concepts of ECOSAN and its relevance in Nepal, and provides technical details on different types of ECOSAN toilets.

The main objective of this manual is to assist in introducing and scaling up ecological sanitation as an approach to environmental sanitation. The structure of this Operational Manual has been organized into five different chapters as mentioned below.

Chapter 1 Provides Introduction on the Basic Concept of ECOSAN

Chapter 2 Provides Concept of Planning for the Promotion of ECOSAN Latrines

Chapter 3 Provides Technological Aspects of ECOSAN and its Design and Management Aspects

Chapter 4 Provides General Guides on the Implementation and Construction Aspects of ECOSAN Latrines

Chapter 5 Deals with the Common Problems and Troubleshooting; Potential Problems and Constraints; Dos and Don'ts



Planning for ECOSAN latrines

2.1 Knowledge management on ECOSAN

ECOSAN projects are more complex than conventional systems, being trans-sectoral and including topics ranging from calculating diameters of pipes to the analysis of cultural habits. The stakeholders however should have a central role in these planning processes. Thus a stakeholder analysis, awareness raising, education and information is necessary, to allow an informed choice. Practitioners may therefore require a different set of tools and instruments to prepare and plan projects, chose technologies, implement, monitor, and evaluate the system. So far mainly the material and social aspects have been addressed.

To date, most planning and implementing systems for conventional sanitation have tended to be highly centralized, hierarchical and bureaucratic, focusing on formal knowledge, and severely limiting opportunities for the participation of a range of stakeholders. The practice of centralized sanitation planning, decision making and financing removes central planners from the daily experience and problems of the users. Sanitation practice, for example, has not significantly changed as it has not benefited from the insights and knowledge of modern environmental management.

In contrast, the planners should be more open to and familiar with either environmental management, or traditional knowledge, they might understand that the processes of generation and management of faeces, urine, and are intricately related to social and cultural values and norms. The equipment and treatment used, the necessary maintenance, cultural and religious rules, the conditions under which these materials may be recycled, govern much of behaviour. These factors are normally bundled under the terms “comfort, cleanliness, and convenience.”

Participation in ECOSAN projects also adds to the knowledge available for planning. This helps to serve to include appropriately the different interests, needs, priorities, and conditions, as well as the economic and organisational potential and limits of the different stakeholders, in the decision making

process without contradicting the needs of other participants. Open channels of communication between users and system providers are a key feature of modernized socio-technical systems, which build an element of user choice and discursive awareness into the planning process (Spaargaren Andvan Vliet 2000).

2.2 Planning of ECOSAN

ECOSAN systems may, for the user, seem more complex than conventional sanitation systems, and they do usually place more responsibility for appropriate functioning on individual families and local communities. Users must become aware that, despite potential health benefits, improper use of any toilet may turn it into a nuisance, threaten public health, and pollute the environment. These problems can best be avoided by adopting the appropriate behaviours from the outset. In addition, special care is required to take full advantage of the significant resource potential of the recycled plant nutrients.

At the household level individuals and families must understand how the ECOSAN system works, what can go wrong, and have the commitment and skills to manage it correctly. For large-scale application, it is also essential that a significant part of the local community shares this understanding and commitment.

In urban areas the fundamental issue of ECOSAN is how to establish a full-scale operation. It is one thing to operate scattered ECOSAN devices spread over a large rural area; it is a different matter to make thousands of ECOSAN devices work properly in a densely populated urban area.

This chapter will examine issues related to planning, promoting and supporting ECOSAN systems on a larger scale..

2.3 Foundation of planning for ECOSAN latrines

Planning for ECOSAN systems takes place in much the same way as planning for conventional sanitation systems has taken place in the past. The quantity and quality of its water resources, its existing sanitation systems, and its storm drainage should be considered. Like all other development planning, decisions as to whether to incorporate ECOSAN options into the existing system, or to maintain and extend an aging sewerage system, should normally be taken in a participatory approach.

Planning for sanitation and water supply systems should begin at the local level and moves upwards, and when communities have more choice, there is a greater chance of achieving sustainable systems. This is because the systems are planned in accordance with local ecological conditions and local cultural practices. Community management systems is now common in many parts of the world. Water committees are formed at the start of new projects and they participate in the design of the new scheme. Experience shows that sustainability is more likely when users feel a sense of ownership of the systems because they selected the design, participated in construction and made key decisions along the way.

The same principle can be applied to ECOSAN systems. Local government authorities and local community groups should form partnerships to lead

sanitation programmes. Sanitation committees can be formed in communities to lead in the planning and implementation and to develop a sense of ownership and responsibility for community sanitation.

The Foundation of planning for ecological sanitation can be considered as:

1. Human dignity, quality of life and environmental security at household level should be at the centre of the new approach, which should be responsive and accountable to needs and demands in the local and national setting.
2. In line with good governance principles, decision-making should involve participation of all stakeholders, especially the consumers and providers of services.
3. Waste should be considered a resource, and its management should be holistic and form part of integrated water resources, nutrient flows and waste management processes.
4. The domain in which environmental sanitation problems are resolved should be kept to the minimum practicable size (household, community, town, district, catchment, city) and wastes diluted as little as possible.

Project planning steps

1. Identify Suitable Pilot Site
2. Assessment of current status with Stakeholders
3. Awareness Raising Approach (Promotion)
4. Possible Sanitation Technologies (Product)
5. Operation and Maintenance and Reuse Concept
6. Logistics (Place)

7. Stakeholder Training
8. Monitoring and Follow-up
9. Finances (Price)
10. Implementation Schedule and Responsibilities

Points to be considered in planning and implementation of ECOSAN projects

- ◆ Integration of reuse aspects in the assessment of the current situation and in all the planning activities and conceptual work
- ◆ Including integration of aspects concerning solid waste management and water supply (rainwater harvesting, grey water treatment and reuse)
- ◆ Consideration of a much wider variety of sanitation solutions with respect to centralised or decentralised, conventional or closed-loop oriented, high tech or low tech, and the corresponding institutional and management solutions
- ◆ Application of new and wider ranging evaluation criteria for water and sanitation services
- ◆ Adaptation to the information and output needs of the stepwise and participatory project preparation and implementation process, in order to enable the stakeholder to make an “informed choice”
- ◆ Need to focus on the need assessment of the users of the sanitary facilities and other relevant stakeholders, particularly service providers and end users of the recycles.
- ◆ Consideration of smaller planning units and a greater number of decentralised options
- ◆ Integration of education, institution and capacity building aspects into planning instruments

Planning for ECOSAN projects

Figure 4:
10 Steps approach for ECOSAN project

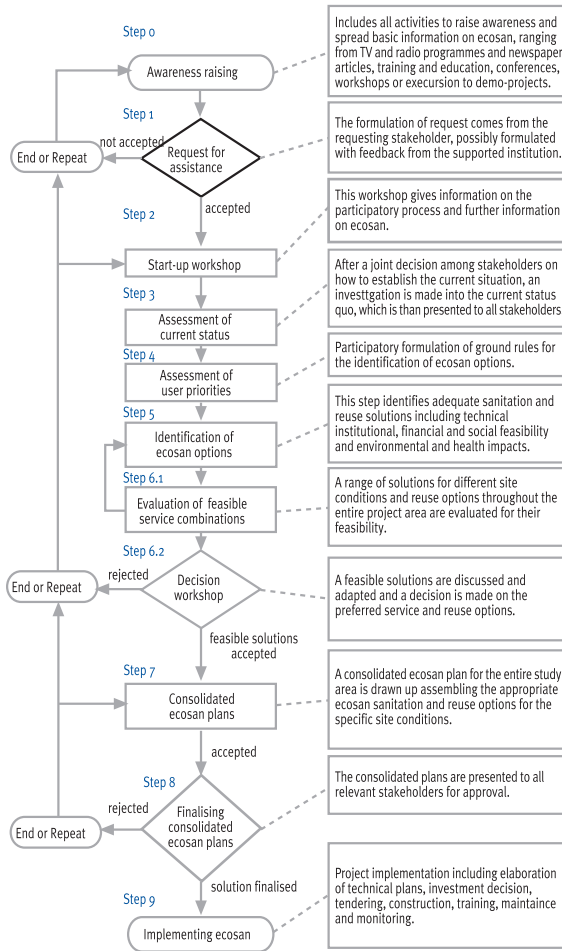
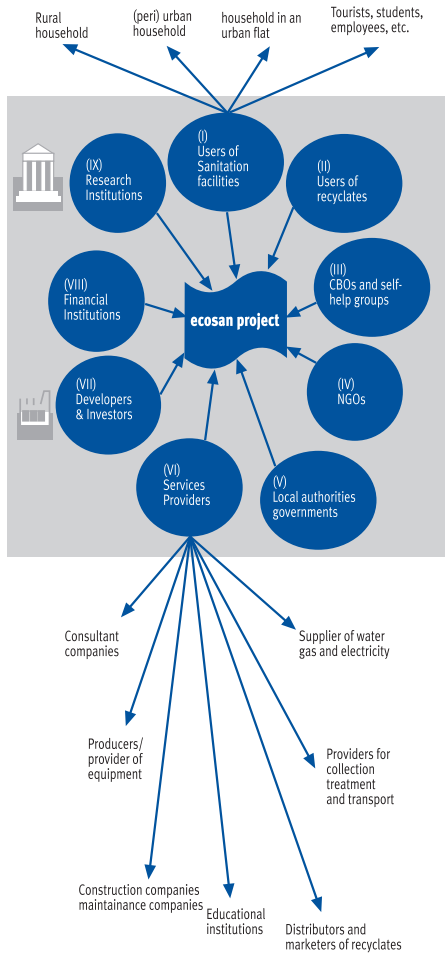

Figure 5:
Stakeholders in an ECOSAN Project



Source: ECOSAN programme GTZ



Technology, design and management

The ecological sanitation systems and eco-toilets are neither widely known nor well understood. They cannot be replicated without a clear understanding of how they function and how they can malfunction. They have several unfamiliar features, such as urine diverting toilet seats and squatting slabs and pans, which may raise questions about their cultural acceptability. Much has been learned about ecological sanitation systems from the many units in use in the world today. In this chapter we describe the design and management features of ecological sanitation toilet systems, so that mistakes can be avoided. The purpose of the chapter is first to provide an overview of the variables that influence the choice of an appropriate sanitation system, then to discuss the possibilities in dealing with liquids and in sanitizing solids, and finally to discuss a number of design options.

Conventional sanitation solutions assume that the environment can handle the waste, or they shift the burden to downstream communities. Ecological sanitation, on the other hand, minimises the reliance on external inputs, while simultaneously reducing the output of wastes from the system. There are two basic design features of ecological sanitation.

- ◆ One is urine-diversion, in which urine and faeces are never mixed. The pedestal has a dividing wall, in which the urine exits from the front of the toilet, and faeces drop below the toilet from the back of the bowl.
- ◆ Another design combines urine and faeces, at which point urine and faeces can be processed together or separated.

In either case, it is possible to manage urine, faeces or excreta with little or no water, and it is also possible to keep the end-product out of ground and surface waters. Pathogens are treated close to the point of excretion. Nearly all pathogens in excreta are found in faeces, while urine is sterile with few exceptions.

Evidence to date (Stenström 1999) indicates that the addition of lime or ash helps to desiccate faeces and raise the pH, which can effectively kill off pathogens within several months. Faeces, once desiccated, may be returned to soil or composted with organic household refuse if there is some concern that pathogens still exist. If it is suspected that pathogens

survive the desiccation/pH phase, they can be killed within days at temperatures above 50°C or within a relatively short time during thermophilic composting (Feachem et al. 1983). Of course, over time pathogens will die if kept out of water and left undisturbed by weather or animals.

If urine and faeces are combined, as is usual in conventional systems, it is harder to render excreta safe, though not impossible. More time, thermophilic composting and sometimes chemicals, such as chlorine, are necessary then to kill bacteria.

In general, conventional sanitation solutions fail to treat excreta on- or off-site. Over 90% of sewage in developing countries is discharged without any treatment, into receiving bodies of water, and the figure for Latin America, which has the highest rates of water-borne systems, is 98% (Briscoe and Steer 1997).

3.1 Factors influencing design and management

Many local variables influence the choice of an ECOSAN system:

- ◆ **Climate:** temperature, humidity, precipitation and solar radiation. In dry areas it will be easiest to sanitize faeces through dehydration, whereas composting may be more successful in humid areas.
- ◆ **Population density and settlement pattern:** the availability of space for on-site/off-site processing, storage and local recycling.
- ◆ **Social/cultural:** the customs, beliefs, values and practices that influence the design of the social components of a sanitation system, its acceptability

by a community. (It should be noted, however, that these things are not static, and that new practices are constantly evolving in most societies.)

- ◆ **Economic:** the financial resources of both individuals and the community as a whole to support a sanitation system.
- ◆ **Technical capacity:** the level of technology that can be supported and maintained by local skills and tools.
- ◆ **Agriculture:** the characteristics of local agriculture and homestead gardening.
- ◆ **Institutional support:** legal framework, extent of support for the ECOSAN concept in government, industry, financial institutions, universities and NGOs.

3.2 Dealing with faeces

The primary processing in an ECOSAN system is generally either through dehydration or decomposition, but a combination of both is also possible. The purpose of the primary processing is to destroy pathogenic organisms, to prevent nuisance and to facilitate subsequent transport, secondary processing and end use.

Dehydration: Dehydration means lowering the moisture content of the material in the processing vault or container to less than 25% through evaporation and addition of dry material (ash, sawdust, husks). No water, urine or moist plant material must be added to the processing chamber. There is little reduction in volume because of the added dry material, and minimal decomposition of organic material because of the low moisture content. The crumbly pile that remains when faeces dry out is not compost but rather a kind of mulch which is rich in nutrients, carbon and fibrous material.

Dehydration is a way of destroying pathogenic organisms. It does this by depriving them of the moisture they need to survive. At this low moisture content there is little odour and no fly-breeding. As there is so little breakdown of organic material, toilet paper or other things placed in the processing vault will not disintegrate regardless of storage time. Toilet paper must therefore either be handled separately (commonly by burning it) or be composted in a secondary treatment process.

Urine diversion is essential in eco-toilets based on dehydration. Where water is used for anal cleaning, this water should be diverted and can either be treated separately or mixed and treated with the urine.

Decomposition (composting): is a complex natural biological process in which organic substances are mineralized and turned into humus. The speed of decomposition is influenced by a number of environmental factors inside the pile such as the amount of oxygen (aeration), temperature, moisture, pH value, the ratio of carbon to nitrogen (C:N ratio), competition among micro-organisms for nutrients, and the toxic by-products of decomposing organisms.

Aeration: Some of the micro-organisms in the pile need oxygen in order to play their role in decomposition. Such organisms are called aerobic. Others that do not require oxygen are called anaerobic. Many organisms can survive conditions with and without oxygen. Air enters the processing chamber from the outside or is trapped inside the compost heap. Near the surface of the pile the process may be aerobic while in the interior it is often anaerobic. Under aerobic conditions, decomposition is rapid and odour-free. Under anaerobic conditions decomposition is

slower and foul-smelling and the heat given off is only a fraction of that under aerobic conditions. Earthworms and insects play an important role in aeration by burrowing holes through the pile.

Temperature: High-temperature aerobic composting (with temperatures reaching $>60^{\circ}\text{C}$) will effectively destroy most pathogenic organisms, but such process temperatures are in practice difficult to reach in a composting toilet. The volume of material is too small, it tends to be too compact and it is difficult and unpleasant to turn the pile to aerate the central part. Occasionally higher temperatures can be found in a small part of the pile. To raise the temperature for faster decomposition and faster die-off of pathogens, there should be a large input (four to five times the weight of faeces) of carbon rich material such as weeds, husks, wood shavings and kitchen waste, combined with occasional turning to ensure a good supply of oxygen to the inside of the pile.

It's important to remember that temperature is not solely important for destroying pathogens. Pathogen destruction is a function of both temperature and time, so that lower temperatures can achieve acceptable pathogen kill if the material is retained long enough. In many cases, this lower temperature/longer time strategy is preferable to more intensive management of the compost pile. Most composting toilets are designed for a retention time of 8–12 months.

Moisture: In a composting toilet we get the best results in terms of pathogen destruction with a moisture content of 50–60%. At higher moisture content conditions in the material become

soggy and compact, and the organisms are deprived of oxygen. A low moisture content, on the other hand, slows down the activity of the micro-organisms, as they are starved for water.

An extremely wet compost toilet may result from a combination of some of the following factors: humid climate, water used for anal cleaning, too much urine has gone in, too many users (too much urine in relation to capacity to handle liquids), no addition of organic refuse, unventilated processing chamber, entry of rainwater, surface water or groundwater. The most common reason for high moisture content in the pile is too much urine going into the processing chamber. This can be corrected by installing a urine-diverting toilet seat or squatting plate which channels the urine away from the compost pile into a separate container. Another possibility is to have some type of false floor which allows the liquid to seep out, preferably into a place from where it can evaporate.

Ratio of Carbon to Nitrogen (C:N):

Micro-organisms feed on organic matter containing, among other nutrients, carbon and nitrogen. Carbon is used for energy and nitrogen is for body building. The optimum carbon to nitrogen (C:N) ratio is within the range of 15:1 to 30:1 in the initial mixture.

Since faeces, and especially urine, are rich in nitrogen, it is best to start a processing chamber with materials rich in carbon such as green grass clippings, vegetable scraps, straw, husks, wood shavings or a combination of these. Addition of these materials to the compost increases the C:N ratio. Excluding urine from the compost has a similar effect, as it lowers the amount of nitrogen in relation to carbon. The addition

of layers of finely chopped carbon-rich material also helps to provide oxygen to the pile and to achieve rapid and complete decomposition.

Life in the compost latrine: A rich variety of organisms lives in the compost heap and contributes to the breakdown of the excreta. They range in size from viruses, bacteria, fungi and algae to ants, mites, spiders, sowbugs and earthworms. Their activities are responsible for rapid decomposition. Earthworms and insects mix and aerate the pile, tearing apart the contents. If the environment is favourable to them, they will multiply, burrow holes in the pile, eat odorous organic material and convert it all into humus.

3.3 Dealing with liquids

A basic question when designing an ECOSAN system is whether to divert urine or to mix urine and faeces in a single receptacle. If the latter approach is used, effective processing will, with few exceptions, require later separation of liquids and solids. Thus we start with two basic options: divert urine; or mix urine and faeces.

Figure 6: ECOSAN systems have two basic options for dealing with liquids: divert urine (left) or mix urine and faeces (right)



Diverting urine

There are a number of good reasons for not mixing urine and faeces:

- ◆ it keeps the volume of potentially dangerous material small;
- ◆ the urine remains relatively free from pathogenic organisms;
- ◆ urine and faeces require different treatments;
- ◆ it simplifies pathogen destruction in faeces;
- ◆ it reduces odour;
- ◆ it prevents excess humidity in the processing vault; and
- ◆ the uncontaminated urine is an excellent fertilizer.

Urine diversion requires a specially designed seat-riser or squatting slab or pan that is functionally reliable and socially acceptable. The basic idea of how to avoid mixing urine and faeces is simple: the toilet user should sit or squat over some kind of dividing wall so that faeces drop behind the wall and urine passes in front of the wall.

The idea of not mixing urine and faeces is not new. In some parts of peri-urban areas of Kathmandu of Nepal, simple toilets with urine diversion have been in use for centuries.

In recent years several factories have started producing squatting pans as well as seat-risers with urine diversion. The faeces drop down into either a composting or a dehydrating chamber.

Once collected the urine can either be used directly in the garden, infiltrated into an evapotranspiration bed, or stored on site for later collection either as liquid fertilizer or further processed into a dry powder fertilizer.

Facts findings about urine application

- ◆ Human urine could act as effective as chemical fertilizer if nutrient losses could minimize
- ◆ Urine should be applied preferably in three split at different crop growth stage :

Figure 7:

Historical examples of urine diversion. The one from China (left) is emptied every day: urine is used directly as liquid fertilizer and faeces placed in a compost pile together with animal manure. In the example (right) urine is evaporated and faeces dehydrated and reused as fuel

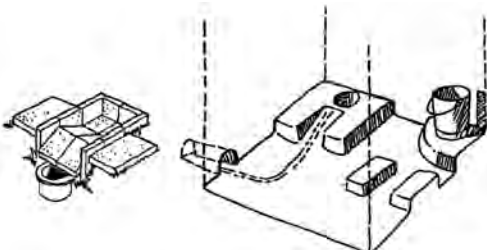

Figure 8:

Urine diversion: to the left a prefabricated squatting pan, to the right a bench-type seat riser, built of wood and with a standard plastic funnel as urine collector

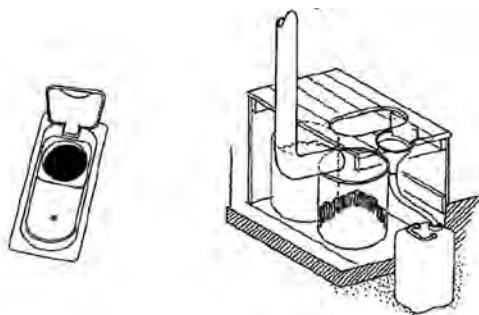
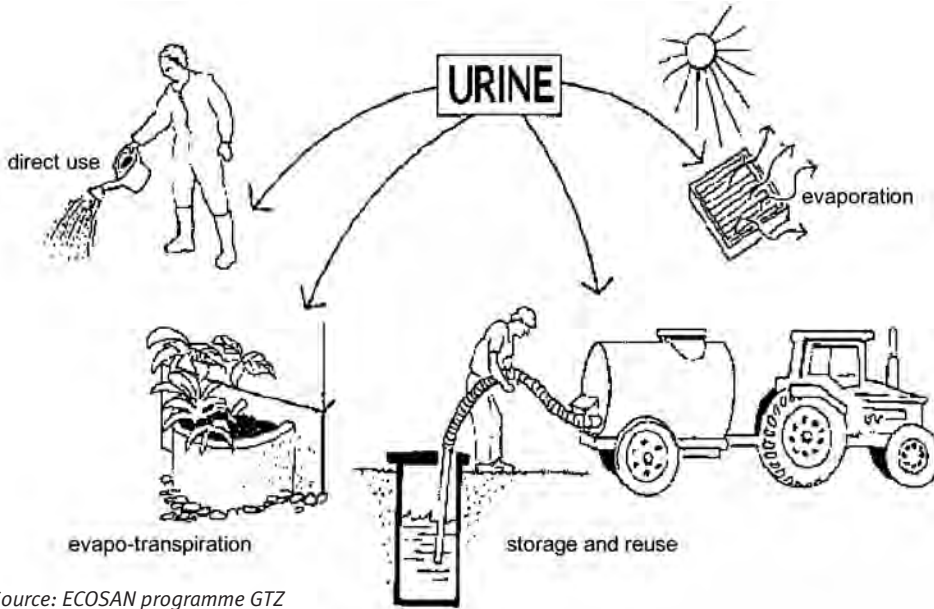

Figure 9:

Alternative ways of handling urine diverted from faeces: used directly, disposed of in an evapo-transpiration bed, stored in a tank for later use or evaporated



Source: ECOSAN programme GTZ

- Before planting
- 25-30 days
- 45-50 days
- ◆ Urine can be applied in 2 split for short duration crop like potato
- ◆ conduct long term (3-4 years) experiment to see the effect of urine on soil properties and plant health
- ◆ Urine should be supplemented with compost
- ◆ Recommended Urine Dosage: Urine/Ropani
Heavy feeder crop/Infertile soil : 1500 lit.
Low feeder crops/fertile soil : 750 lit.

Although urine-diverting toilets have a long history the concept is, in most parts of the world, unfamiliar and many people find it hard to believe that they work properly. Sometimes newcomers

to the systems remark that they do not believe they can be used by males. Others question whether they can be used by females.

Figure 10:
Urine diversion

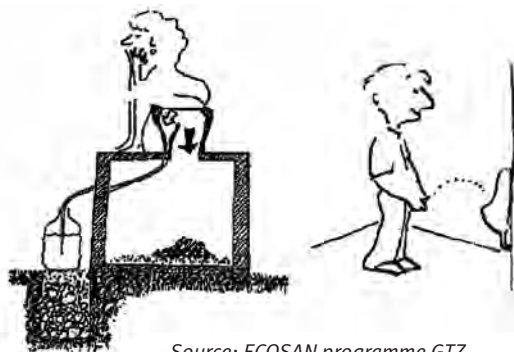

Source: ECOSAN programme GTZ

Experience shows that these designs work equally well for both sexes, as long as they squat or sit. Some communities have designed their toilet units with separate urinals for men so that the main seat riser or slab does not have to be used by those who prefer to stand when urinating.

The large size of seats and slabs, however, sometimes poses problems for small children, and some options are designed so that a smaller seat can be pulled down over the larger basic seat-riser.

Mixing urine and faeces

Systems based on liquid separation do not require a special design of the seat-riser or squatting plate. Urine, faeces, and in some systems a small amount of water, go down the same hole.

Another possibility is to drain the liquid from the processing chamber through a net or a perforated floor as in the example below.

One of the main points that must be considered in liquid separation systems is that, as the liquids have been in contact with faeces, they must be evaporated, sterilized or otherwise treated before they can be recycled as fertilizer. In rural, basic toilets in warm and dry climate it is possible to process liquids and solids together. Urine and faeces go down the same hole. Dry soil or a mixture of soil and ash are added to the urine-faeces mix in the pit. Biological activity, in the combination of excreta and added soil, results in a useful soil conditioner and fertilizer over time. Since some of the liquids percolate into the soil, these types are not suited to areas with a high water-table.

Figure 11:

An Aquatron device for separation of liquids and solids from a minimum-flush toilet. The separator is placed on top of a processing (composting) chamber. The liquids are sanitized with ultraviolet radiation in a separate unit

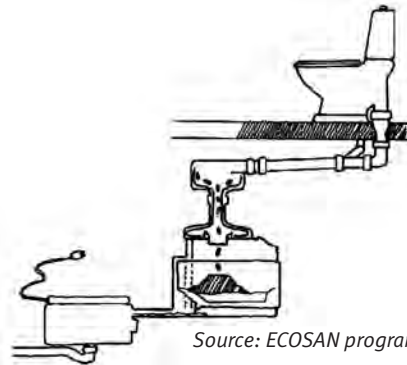

Source: ECOSAN programme GTZ

Water for anal cleaning

In some cultures, washing after defecation is mandated by tradition or religion, like Nepal and India. In some Islamic cultures, people traditionally wash away from the toilet opening. The water used for anal cleaning can be treated in an evapo-transpiration bed.

3.4 Preventing odours and flies

Sceptics claim that ECOSAN is an inferior alternative: it will be smelly, fly-producing and incompatible with modern living. This is a valid concern as ECOSAN systems are sensitive to bad design and careless operation. If they are not designed, built and operated properly, taking into account natural environment, traditional beliefs and the chosen process (dehydration or decomposition), they may indeed smell and can even provide a habitat for flies.

Fly breeding in toilets is basically related to the wetness of the contents of the processing vault. In a properly functioning dehydration system there would be no fly breeding, but if something goes wrong and the contents turn wet, fly breeding might occur. The risk of fly breeding is greater in a composting system for two reasons: it works with a much higher process moisture content and fly eggs may be introduced into the processing vault with kitchen scraps. When a properly selected and well built eco-toilet fails, the most common fault is that the process has turned wet. In a system based on dehydration the moisture content of the contents of the processing vault should quickly be reduced to less than 25% through the addition of dry additives and ventilation – in some cases helped by the addition of a solar heating device. In a system based on decomposition the corresponding moisture content should ideally be between 50% and 60%. If this is achieved and fresh faeces are covered with an absorbent, there is no smell, no fly-breeding and rapid pathogen destruction.

3.5 Household management: removal and treatment

Probably the most unfamiliar aspect of ecological sanitation options is that they may require some handling of processed or partly processed human excreta at the household level. In most existing ECOSAN projects this has been necessary because the projects were small and scattered. Each household therefore had to manage the total system: daily care of the eco-toilet; weekly/monthly emptying of the storage tank for urine; recycling of urine in the garden; monitoring the primary processing

chamber for faeces; half-yearly emptying of the processing chamber, secondary processing of chamber content; and the end use of the sanitized material. With proper motivation and instruction this management by the household can work well.

The advantage of this approach is that the user gets a direct feedback and can gradually improve his/her operation: take greater care in not allowing urine and water into the processing chamber, increase the amount of ash/lime, etc.

Problems tend to occur when new tenants/owners are taking over. As eco-toilets are still relatively unfamiliar the risk is that the newcomers do not understand how to use them. And without instruction they would not know why and how to empty urine tank and processing chamber, or about the need for secondary processing, etc.

3.6 Technical options

Solar heaters

Solar heaters can be fitted to the processing chambers of the toilet to increase evaporation. This is more important in humid climates and where urine and water are mixed with the faeces. It is also more important in a system based on dehydration than in one based on decomposition.

The main purpose of the solar heater is to increase evaporation from the material in the processing chamber. It is also likely to slightly increase the temperature of the pile in the chamber and there are indications that pathogen destruction is faster in solar heated than in non-solar heated chambers. The increase in pile temperature is, however, unlikely to be high enough for high-temperature composting.

Figure 12:
An eco-toilet with solar-heated processing chamber



Source: ECOSAN programme GTZ

The solar heaters used in some of the eco-toilets described in the previous chapter consist of a black-painted metal (aluminium) sheet covering the part of the processing chamber exposed to the sun. This metal sheet may also act as an access lid to the processing chamber (see Figure 13).

The solar heater must be fitted so that it prevents water and flies from entering the processing chamber(s). It should be tight enough to prevent air leakage.

Single or double vault

Most eco-toilets built so far have two vaults, each with its own seat riser or squatting slab or with a movable device. The advantage with the double-vault design is that each vault is used alternately for a certain period. When the first vault is full it is left dormant and the second vault is used. The contents of the dormant vault are emptied when the

Figure 13:
A single-vault, solar-heated eco-toilet with moveable containers, in this case two large baskets. When the first basket is full it is placed directly under the solar heater and remains there until the second basket is full



Source: ECOSAN programme GTZ

second vault is nearly full. The assumption is that after a specified period (6–12 months depending on climate) without new faecal material added, the contents of the dormant vault should be safe to handle. A single vault toilet with two or more moveable containers would offer the same advantage. For ECOSAN systems with communal management moveable containers probably offer a more rational solution than fixed vaults or processing chambers.

Ventilation: Ventilation serves several purposes: it removes odours, it dries out the contents and, in composting toilets, provides oxygen for the decomposition process. A vent pipe is not always necessary. The need for a vent pipe is determined by climate, wetness of the input into the processing chamber and standard desired. (With a well-functioning vent pipe from the processing chamber, the toilet/

bathroom can be completely odour free, as air from the room is evacuated via the drop hole in the seat-riser/ squatting-pan.)

A vent pipe should have a diameter of 10 – 15 cm. In extremely humid climates the diameter could be larger – up to 25 cm as in the example from Micronesia. The pipe should be as straight as possible as bends reduce draft, and reach 50–90 cm above the roof. If necessary the vent pipe can be fitted with a small electric fan.

Aeration: Composting is basically an aerobic process. Many of the microorganisms responsible for the decomposition need oxygen. Air must therefore be brought into the pile. In some cases the processing chamber is provided with perforated pipes that bring air into the centre of the pile. Aeration can also be accomplished with the addition of a bulking agent that creates air pockets inside the pile.

Climates: Dehydration toilets are mainly suitable for regions with high average temperatures, long dry and short rainy seasons or arid climatic conditions with high evaporation rates. Nevertheless, with simple solar heaters, they can also work in a more humid climate.

Dehydration toilets are waterless systems that are particularly suitable for conditions where water is scarce.

3.7 Maintenance

All sanitation technologies require maintenance to function properly. The amount of maintenance that users of ECOSAN systems need to do varies a

Figure 14:
A mechanical, pedal-operated, ash dispenser used for school toilets in China



Source: ECOSAN programme GTZ

great deal and is influenced as much by the organisation of operation and maintenance as by the design of the ECOSAN devices.

Good system design can minimize the need for intensive maintenance, and the tasks required need not be onerous. For example, systems that rely on composting often require the regular addition of bulking agents and periodic checking to ensure that vent pipes are not blocked by debris, spider webs or nesting insects. Some systems may require the transfer of partially processed solids to a secondary processing area. Many systems require that the toilet seat-riser or squatting hole be in some way closed-off when not in use.

All systems require periodic inspection and removal of the end products. Particularly urine collectors, pipes and containers/ tanks need to be monitored. Urine pipes should be flushed periodically to avoid accumulation of deposits, which can block the flow and generate unpleasant odours.

The major common element in the maintenance of ECOSAN systems is that the user must ensure that the system is working properly. However, it is important to note that many operations and maintenance functions, such as emptying of toilet vaults, transport and secondary treatment can be carried out by special service providers, either as a public service or through private enterprise. Service contracts will minimize the burden on households and also enable municipal administrations to guarantee a satisfactory standard of operation and maintenance.

Anal cleaning material: Cultures differ in their use of cleaning materials after defecation. Some use paper, some use vegetable material, mud balls or stones, and others, as mentioned above, use water. The inappropriate disposal of cleaning material in a toilet can cause problems. In some parts of the world the drainage system for WCs cannot cope with large amounts of toilet paper, so this has to be collected separately in a bin for later disposal by burning. Elsewhere WCs have rapidly been rendered useless by people trying to dispose of stones or maize cobs in the toilet.

Dry systems can take all kinds of paper and solid objects and still function well. As mentioned above a dry system can even be adapted to cope with the use of water for anal cleaning.

During the process in a composting toilet paper breaks down, but not in a dehydrating toilet – the paper does not decompose. This paper will, however, break down during secondary processing if the process used is composting or carbonization/ incineration.

Absorbents and bulking agents:

Absorbents such as ash, lime, sawdust, husks, crushed dry leaves, peat moss and dry soil are used to reduce smells, absorb excess moisture, and make the pile less compact as well as less unsightly for the next user. Absorbents should be added immediately after defecation in order to cover the fresh faeces. They are used in both dehydrating and in composting toilets.

Bulking agents such as dry grass, twigs, coconut fiber and wood shavings are used in composting toilets to make the pile less compact and allow air to enter and filter through the heap.

In the nineteenth century in Europe there were a number of designs for ‘earth closets’, with a lever-operated mechanical device to sprinkle earth and/or ash on to the faeces. A similar device is used in current ECOSAN projects in China.

Materials and workmanship:

ECOSAN is, like any sanitation system, sensitive to poor workmanship and defective materials. But in some ways ECOSAN systems are less sensitive: the processes involved are dry and the volumes handled comparatively small. Common faults include seepage of water into the processing vault, leaking or blocked urine conduits and blocked vent pipes.

3.8 General hygiene aspects of ECOSAN latrines

- ◆ Urine diversion is always recommended. This reduces the amount of faecal material to be sanitized and lowers the risk for disease transmission. This also reduces odours and flies.

- ◆ Faecal collection should occur above ground in closed compartments that will not leak into the groundwater or the surrounding environment.
- ◆ Handling and transport systems should involve minimal contact with the faeces.
- ◆ Toilet paper and material such as tampons and sanitary pads/napkins should only be put into the toilet if they are bio degradable. Otherwise, they should be treated as solid waste.
- ◆ Anal cleansing water should not be mixed with urine, but infiltrated into soil or added to the grey water and subsequently treated.
- ◆ Contents of potties and diapers/nappies and should be put into the faecal compartment.
- ◆ Further addition of absorbent material, such as ash or lime, or a bulking agent, such as sawdust, may be needed when diarrhoea is prevalent.
- ◆ Hygienisation through heat and high pH: Within the chamber, the moisture content is reduced to about 25% and temperature can rise up to 50 °C. This enhances the destruction of pathogens inside the chamber. Pathogen destruction is further enhanced by addition of alkaline material, such as lime or ashes.
- ◆ Careful handling required:
 - ◆ An important condition for the success of dehydration toilets is that sufficient user commitment to the operation and maintenance can be provided.
 - ◆ Cleaning of a dehydration toilet seat or squatting pan has to be done carefully with little water, to avoid introduction of water into the vault. A bulking agent has to be added regularly to the faeces. The collection chamber has to be checked and

emptied in regular intervals. In non-urine-diverting versions, the moisture content of the chamber should be monitored and the drainage corrected if necessary.

- ◆ All those tasks require a certain level of responsibility and care from the users. Neglected maintenance can quickly lead to malfunctioning of the process and may impair severely the appearance and hygiene of the toilet.

3.9 Technological aspects

Requirements

The ecological Sanitation Toilets should be:

- ◆ Compatible with the social, cultural and economic conditions of the target areas
- ◆ Be comprehensive to the uses
- ◆ Exploit locally available resources
- ◆ Be simple and easy to operate and maintain
- ◆ Systems must isolate or destroy faecal pathogens
- ◆ Systems must protect the environment
- ◆ Systems must be robust and easy to use and maintain

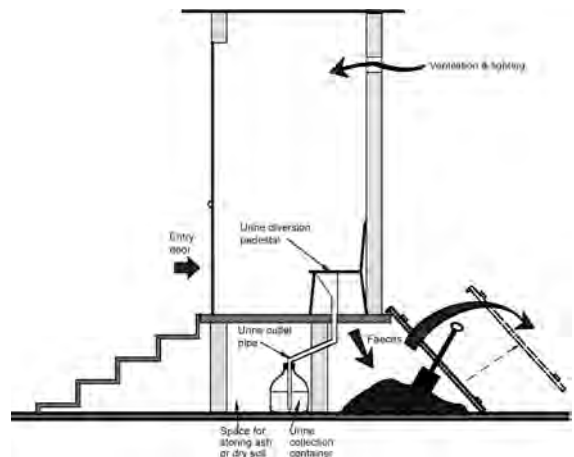

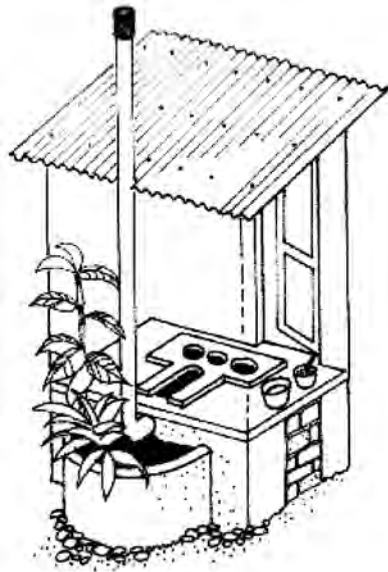

Principles

- ◆ 2 chambers should be used alternatively with 6 to 12 months before removal of material and be built either outside or inside the chambers with access from outside.
- ◆ Can be installed in upscale homes, too
- ◆ Prospective users idea and function, operation can be organised by small local organisation
- ◆ Almost no water shall go into the faecal chamber (take care of wash-water in cultures with wet anal cleansing)
- ◆ Local production and operational services keep money inside the community.
- ◆ ECOSAN has the potential to do good by not increasing the heavy burden of money further.
- ◆ Commercial fertilizer is often imported, urine is a cost efficient alternative
- ◆ Two chamber dry toilet for cultures with wet anal cleansing
- ◆ Urine diversion and usage of urine as fertilizer, solids as soil conditioners after decomposition

- ◆ Community based projects are a key to success, informed choice, information about costs of alternatives, demand for maintenance

Types of latrines considered under ECOSAN systems

- ◆ Urine Diversion (UD) Latrines:
- ◆ Wet ECOSAN (Urine Diversion) Latrines
- ◆ Dry ECOSAN (Dehydration) Latrines
- ◆ Composting Latrines

3.9.1 Urine Diversion (UD) latrines

- ◆ Major difference between UD toilet and other types is that a UD toilet has two outlets and 2 collection systems: one for urine and other for faeces in order to keep excreta fractions separate.
- ◆ UD toilet may or may not mix water and faeces, but do not mix urine and faeces at the point of collection in the toilet
- ◆ Urinal in toilet acts per se as a urine diversion device because urine is collected separately from faeces. When urinals are of waterless version, the can collect the urine pure i.e. without dilution with water.
- ◆ Urine diversion may be used in ECOSAN concepts but not in all because ECOSAN is an approach to sanitation which focuses on options for reuse of nutrients contained in excreta
- ◆ UD Toilet may or may not have a provision for flushing water system (Wet UD) and anal cleansing water (dry UD)
- ◆ Water is used to flush the faeces away and to rinse urine compartment.
- ◆ Composting toilets can be designed with UD toilets
- ◆ Mostly found in developed countries

Purpose of UD latrines

- ◆ *To reduce odour (in dry latrines):* when urine and faeces are not mixed, the odour from a dry (waterless) UD latrine

is much, much less than when urine and faeces are mixed together (as in a pit latrine). Therefore, a dry toilet with UD can even be placed indoors without causing odour problems.

- ◆ *To avoid production of wet, odorous faecal sludge:* Which has to be removed by someone when the pit latrine is full. Faeces collected dry, separately from urine and water, are hardly offensive, especially after an extended drying period in a faeces vault); this is particularly relevant for hilly or crowded areas with difficult access for vacuum trucks to pit latrines.
- ◆ *To reduce water consumption:* in the case where UD devices are of the waterless type or of the water saving type.
 - ◆ To be able to collect urine pure so that it can, after sanitization by storage, be safely used as fertilizer in agriculture. This is particularly important for small scale farmers of developing countries who cannot afford costly artificial fertilizers.

Technical components

- ◆ Waterless urinals
- ◆ Urine diversion toilet
- ◆ Urine piping to a storage tank
- ◆ Reuse system for urine

3.9.2 UD Dehydration (Dry ECOSAN) latrines:

Principles

- ◆ The faeces / excreta are collected in a dry state in a chamber below the toilet (or squatting hole) and excreta in-side the processing vault are dried with the help of sun, natural evaporation and ventilation.

- ◆ They are not designed for composting to take place in faeces chamber
- ◆ High temperature in the chamber, together with sufficient ventilation is the most important mechanisms in the drying process.
- ◆ For the faeces, straight drop or chute is provided to a collection chamber (vault) below the toilet and are dried.
- ◆ A vent pipe is provided to ventilate faeces chamber, reduces odour from the room due to air currents (which flow towards the vent pipe out of the chamber), and to speed up the drying (digesting) process.
- ◆ Moisture content below 25% facilitates rapid pathogen destruction.
- ◆ No flush water is used at all. They use simple system to drain off the urine to a storage container
- ◆ Absorbents, like lime, ash, or dry soil should be added after each defecation to:
 - ◆ Absorb excess moisture, make the pile less compact and make it less unsightly for the next user
 - ◆ Reduce flies and eliminate bad odours.
 - ◆ Increase pH, and hence enhance bacterial pathogen die-off.
- ◆ Breakdown of organic material (e.g. toilet paper) in UDD toilet is very slow in the chamber
- ◆ Once the chamber is almost full, the content need to be removed, further stored, used as a soil conditioner, buried or composted either in home or in local centre.
- ◆ The product from UDD toilet is not compost but rich in carbon and fibrous material, phosphorous and potassium.
- ◆ Nutrients will be available to plants directly or after further decomposition of the dehydrated materials.
- ◆ A third hole and conveyance pipe is used to collect the anal wash water separately from urine and faeces. This should not

be mixed with urine to keep pathogen levels in urine to a minimum, if urine is to be used as a fertilizer

- ◆ Dehydration toilets are increasingly popular in the developing world and can be successfully used in various climatic conditions and are most advantageous in arid climates where water is scarce and faeces can be effectively dried.

The most common type of dry (UDD) ECOSAN latrine in Nepal is based on the Vietnamese model. However, several variations have been made to suit local conditions and requirement of users. The following types of dry ECOSAN latrines can be adopted as they are widely used in Nepal:

Dry ECOSAN with squatting pan: This type of latrine has a single pan or double pan. The double pan version which has two vaults is the most common type and is usually constructed outdoors. The single pan version is more suitable for indoor conditions or where space is a constraint.

Dry ECOSAN with commode: This ECOSAN is similar to the single pan dry ECOSAN, except a special type of commode that has separate outlets for urine and faeces is used instead of a squatting pan. This type of ECOSAN is more common in western countries. As the commode required for

this type of toilet is not readily available in the market and most Nepalese are used to squatting pans, this type of ECOSAN is not very popular.

a. Double vault

- ◆ Designed to operate in batches;
- ◆ Collection and storage of faeces is done in twin pit compartments which are used alternately;
- ◆ After each use a handful of cover material (wood ash, saw dust, soil, etc.) is sprinkled over the faeces to absorb moisture and help in speeding up the dehydration process;
- ◆ When “full”, the respective compartment is sealed off while the other compartment is put in use;
- ◆ Storage time is counted from the date of the last faecal matter contribution to a compartment and should be at least one year;
- ◆ Urine and anal cleansing water diversion is recommended for practical reasons;

Summary

- ◆ **Reuse:** Reuse of urine and compost possible;
- ◆ **Social acceptance:** Proper training on how to use the toilet and how to maintain it has to be done; Social acceptance difficult in cultures where handling of human wastes is a taboo;



- ◆ **Water saving:** No water used for flushing;
- ◆ **Suitability for Difficult Ground Condition:** Especially appropriate for water scarce areas (no flush required) as well as for rocky, flood-prone and high-groundwater table areas (whole construction above ground and water tight).
- ◆ **Affordability:** Higher investment costs compared to conventional pit latrines but revenue from fertilizer value of urine and compost;

b. Single vault

- ◆ Single-Vault UDD-Toilets, unlike Double-Vault UDD-Toilets, provide only one collection compartment for collection and/or containment of faeces;
- ◆ Building costs of a single vault device is less than of a double-vault;
- ◆ Secondary storage or other types of treatment (e.g. co-composting, etc.) must be planned for;

- ◆ Urine and anal cleansing water diversion is equally important for Single-Vault UDD-Toilets as for dehydration toilets providing twin compartments;

Summary

- ◆ **Reuse:** Reuse of urine and compost possible;
- ◆ **Water saving:** No water used for flushing;
- ◆ **Social acceptance:** Proper training on how to use the toilet and how to maintain it has to be done; Social acceptance difficult in cultures where handling of human wastes is a taboo;
- ◆ **Suitability for difficult ground condition:** Especially appropriate for water scarce areas (no flush required) as well as for rocky, flood-prone and high-groundwater table areas (whole construction above ground and water tight).
- ◆ **Affordability:** Less expensive than Double-Vault UDDs, but secondary storage or other types of treatment (e.g. co-composting, etc.) must be planned for;

Figure 15:

Single Vault dehydration latrine in El Salvador: the pile of faeces is regularly shifted to the rear of the chamber for drying.

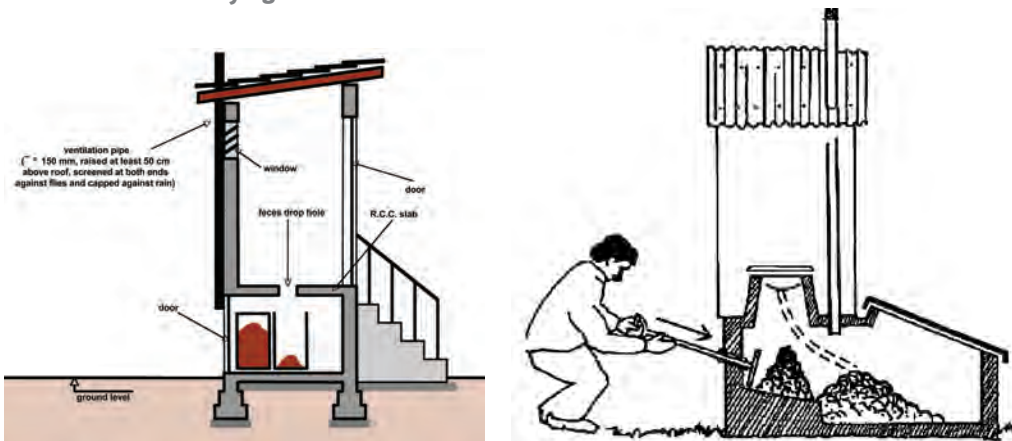

Source: ECOSAN programme GTZ

Time of storage in UD latrines

- ◆ Storage time is counted from the date of the last faecal matter contribution to a compartment and should be at least one year;
- ◆ In warm environment (20 – 35°C), less than one year is sufficient to eliminate bacterial pathogen and substantially reduce viruses, protozoans and parasites
- ◆ Alkaline treatment (raising pH → 9) reduces required storage time to about 6 months

Social / Users' acceptance of UD latrines

- ◆ UDD toilet is only an option like any other new technology
- ◆ Handling and use of dry faeces and separated urine may prove particularly difficult to accept by users in certain or socio-cultural-economic settings
- ◆ Often depends on the perception of status connected to the new facility
- ◆ Compared to situation with Open defecation, public toilet or pit latrine, dehydrating latrine generally compare favorably
- ◆ Education and strongly stressing the advantages of dehydration toilets may lead to acceptance
- ◆ Men are required to sit properly for urine separation may lead to acceptance problems than women. This can be overcome by providing simple urinals for men
- ◆ Guests and externals to the house may feel inconvenient to use it. On top of that, guests are required to orient on how to use UDD toilet

Advantages of UD latrines (compared to conventional pit latrines)

General benefits

- ◆ Structures of UDD toilet are more or less permanent

- ◆ Significantly less odor compared to pit latrines but odor is same when UD flush toilets is compared with conventional flush toilets
- ◆ Toilet can be indoors or outdoors thus leading higher securing, privacy and user comfort
- ◆ No production of wet fecal sludge when compared to pit latrines
- ◆ Water Conservation (Savings)
- ◆ Recycling phosphorous from urine is easier if urine is collected pure rather than mixing with Wastewater
- ◆ Ability to use collected urine (rich in nutrient and phosphorous) as fertilizer leading to higher food security for poor farmers and people growing crops
- ◆ Urine diversion may also create business opportunities for the private sector via sale of new UD technology, implementation, management and marketing of urine and digested faeces as compost (after co-compost) to farmers
- ◆ Regular, expensive and often unhygienic emptying from the pit is not required as small dehydrated volume of faeces from the vault of UDD toilet is much easier and more hygienic
- ◆ Product from UDD toilets is drier than from a composting toilet and thus easy to handle.
- ◆ UDD toilets are more resource efficient due to the reuse of potential of product.

Environmental benefits

- ◆ No toilet wastewater production (in case of UDD toilets) as they are not connected to a sewer
- ◆ In case where untreated wastewater is discharged to surface water, another advantage of UDD is the reduced pollution of surface water with nutrients and pathogens

- ◆ Potential of Groundwater pollution in UDD toilet is negligible
- ◆ Minimized toilet related groundwater pollution with nitrate and pathogens because they collect urine and faeces above ground and therefore protects groundwater

Disadvantages/challenges of UD latrines

It depends on:

- ◆ What the situation was like before? (e.g. Did they have conventional pit latrines before of flush toilets before?)
- ◆ What is compared with what?
- ◆ Possible disadvantages/challenges include:
- ◆ Users have to “think a bit”, if they are using UDD toilet for the first time (not applicable to waterless urinals) thus requiring certain level of awareness raising to achieve social acceptance
- ◆ If users do not cooperate, the resulting abuse can result in odor (e.g. if users urinate in faeces compartment, etc.)
- ◆ Anal wash water (cleansing water) has to be collected separately (in case of UDD toilet) or a “messy” toilet (if users defecate in urine compartment of UDD toilet)
- ◆ Maintenance requirements of urine diversion may be higher, to avoid followings, in comparison with conventional sewer-based systems
- ◆ Blockages of urine pipe network due to possibilities of precipitation
- ◆ If urine is not used but infiltrated, this could lead to groundwater pollution with nitrate thus altering soil properties as well

Precautions

- ◆ Sufficient user’s commitment to OandM is required
- ◆ Careful cleaning of Dehydration toilet seat or squatting pan is regularly required to avoid entry of water into vault

- ◆ Collection chamber (vault) has to be checked and emptied in regular basis
- ◆ Neglected maintenance can quickly lead to malfunctioning of the process and may impair severely the appearance and of the hygiene of the toilet.

Available technologies

Although there are many different UDD toilets with different designs, the most popular and successful one is double vault toilet with urine diversion in general. The main distinguishing features are:

- ◆ Urine Diversion or non-urine diversion
- ◆ Use of disposal of urine
- ◆ Single Vault or Double Vault
- ◆ Ventilated vault or non-ventilated
- ◆ Squatting or sitting
- ◆ Dry or Wet Anal cleansing
- ◆ Self or pre-fabricated

3.9.3 Wet ECOSAN (twin pit pour flush) latrines

A Wet ECOSAN latrine separates urine and faeces but water is used for flushing the faeces and the faeces is sent along with the anal cleansing and flush water. The main benefits of this type of ECOSAN is that using the toilet is easier as water can be used for flushing which is a common practice in Nepal, and a separate location for anal cleaning is not required. Furthermore, as it is not much different from the more common types of toilets and



Double vault Vs single UD dehydration latrines

	Double Vault – UDD	Single Vault – UDD
Economics	Investment cost varies largely depending on location and materials used	Investment/Const cost is similar to UDD or pit latrines
	Maintenance cost is very low but in most cases provide economical benefits through reuse of faeces and urine replacing costly fertilizers	
Health and environment	Transform infectious faeces into a safe product, confines pathogens and nutrients to chambers, avoids direct contact between users and fresh faeces, provides at least 6 months for pathogens to be acted	Health risk is comparatively higher - Handling of fresh faeces and contact of dried / stored faeces cannot be avoided
	It is more safer and environmentally friendly than composting toilets, and better than Pit/VIP latrines	
	Environmental health risks result from poor maintenance, that is: <ul style="list-style-type: none"> ◆ Not maintaining of rhythm of chamber use and necessary storage time, ◆ Allowing liquid to enter into faeces collecting vault impairing on drying process, ◆ Poor design and neglect of adding dry and alkaline adsorbents also decreases safety 	Maintenance must be continuous with weekly interventions



there is no need to handle faeces regularly, it may be socially more acceptable than the dry ECOSAN. The main disadvantage is that it uses the same amount of water as an ordinary toilet and utilizing the faeces can be difficult.

- ◆ Are basically Twin-Pit Pour-Flush Toilets;
- ◆ *Innovation*: urine is collected separately to be used as fertilizer;

- ◆ Faeces, flush water and cleansing water (if used) are collected in 2 pits that are used in alternation for about 2 years each;
- ◆ Water infiltrates locally into the soil, faeces are decomposed;
- ◆ About 190 units installed in Nepal

Basic design information:

- ◆ UD flush toilet has a partition in the toilet bowl isolating bowl for urine in front and a bowl for faeces in the back
- ◆ Flushing mechanism for urine part is designed in one of two ways:
 - ◆ Urine pipe stays open and receives a certain amount of flushing water when bowl is flushed
 - ◆ Urine pipe is closed by a valve and receives no flushing water
- ◆ UD flush toilet can be combined with vacuum concept which allows separate collection of urine

- ◆ Odour control in UD flushed toilet is achieved by common water seal in a U bend as in conventional flush toilets but for urine separate type of odour seal are used
 - ◆ The faeces of UD flushed toilet is cleaned in same way as in conventional way
 - ◆ Generally, this is not practiced in Nepal. Very less people are using this and that too in urban areas particularly in Kathmandu
- Summary*
- ◆ **Reuse:** Allows for efficient reuse of source-separated urine, but may need secondary treatment for the reuse of compost;
 - ◆ **Social Acceptance:** High, due to usage of water for flushing;
 - ◆ **Water Saving:** Uses some 1.5 to 2.0 litres for flushing;
 - ◆ **Suitability for Difficult Ground Condition:** Not suitable for areas with hard rock soil, high ground water levels or areas that are prone to flooding due to required excavation for pit and/or possibility of groundwater and surface water sources pollution;
 - ◆ **Affordability:** Relatively low cost due to construction from locally available materials.

Dehydration Latrine Vs Water Flush Latrine:

	UDD toilet	UD water-flush toilet
Advantages	<ul style="list-style-type: none"> ◆ Does not require connection to water supply not to sewer and treatment plant ◆ Collects urine undiluted ◆ Can be home-buit, low cost, simple design ◆ Results in easy-to-handle, dried faeces 	<ul style="list-style-type: none"> ◆ Require hardly any change in user behaviour for people used to flush toilets ◆ No significant odour risk if not used right ◆ Has similar “appeal” for users as flush toilet ◆ Allows collection of urine pure or with flush water (depending on the model) ◆ Can have lower water consumption compared to conventional flush toilet (since less water used to flush after urination), but the actual water used depends mainly on user habits.
Disadvantages	<ul style="list-style-type: none"> ◆ Is prone to odour if users are not sensitised or unwilling to use correctly ◆ Requires paradigm shift for those who are used to flush toilets or who aspire to have flush toilets 	<ul style="list-style-type: none"> ◆ Requires to be connected to reliable water supply and to sewer system (for faeces-water mixture) ◆ Requires treatment step for faeces-water mixture (not manageable by user) ◆ More expensive than conventional flush toilets and than pit latrines ◆ Possible blockages in urine pipe and valve (if valve is used. e.g. Roediger NoMix toilet)
Applicable for developing countries	<ul style="list-style-type: none"> ◆ Yes-rural, peri-urban, public toilets, slums, cities 	<ul style="list-style-type: none"> ◆ Partially - only for wealthier segment of society (similar to application range as for conventional flush toilets)

3.9.4 Composting latrines

Basic concept

- ◆ Use natural processes to produce compost from faeces (and co-substrates);
- ◆ Basic principle is the biological degradation of excreta and toilet paper in a specially designed containers and enhance the process by the use of additives and adsorbents like carboniferous materials (such as sawdust, straw, hay, shredded paper, kitchen waste, etc.) thus balancing carbon-nitrogen ratio;
- ◆ Cleansing water (if used) can be discharged into the composting compartment (if excess liquid is drained away);
- ◆ Requires addition of bulking material (for composting toilets) and absorbing material (for dry toilets);
- ◆ Earthworms may be added to process organics;
- ◆ Operation may be either batch-wise or continuous-flow mode;
- ◆ Urine is usually collected separately or in some types of composting toilets collect and treated together with faeces;
- ◆ Basic Difference with UD Dehydration toilet is the moisture content of faeces within the vault (50% in CT compared to 25% in UDDT);
- ◆ Removes: 90% of N, 60 – 90% of P and 40 - 60% of BOD;
- ◆ Toilet waste is reduced to 10 – 30% of

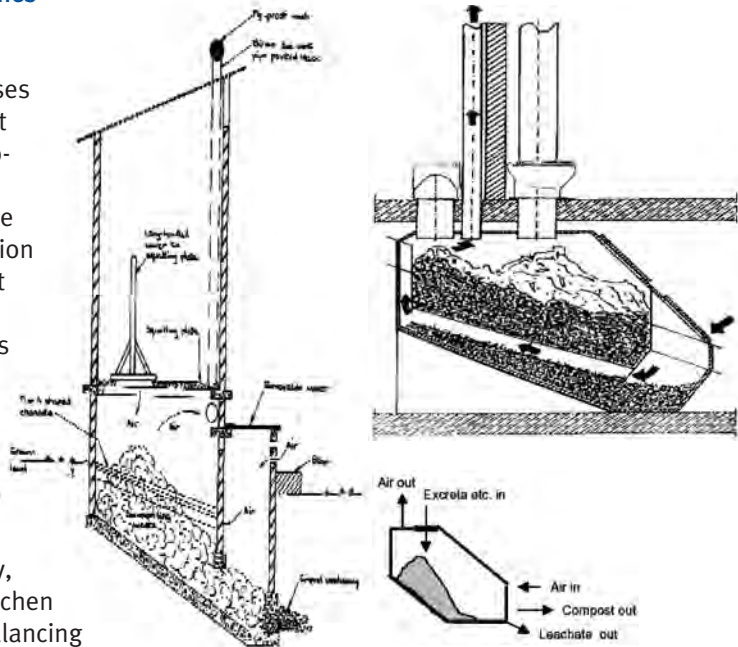

its original volume. That is 70 – 90% volume reduction means 550 litres down to 55 litres;

- ◆ No system above 430C and there is risk of handling digested faeces;
- ◆ To avoid Nitrogen Loss, this technique requires daily care and maintenance;

Applicability of composting toilets (CTs)

- ◆ Composting toilet eliminates the need for flushing water and hence no water supply is necessary
- ◆ With proper management, CT is easy to use and to maintain and the final product is a high quality compost soil conditioner for garden or agriculture
- ◆ It thus allows for recycling of valuable plant nutrients via compost products
- ◆ CTs are sealed system that exclude any infiltration of contaminated liquids into groundwater or other harmful emissions into the environment

Composting toilets

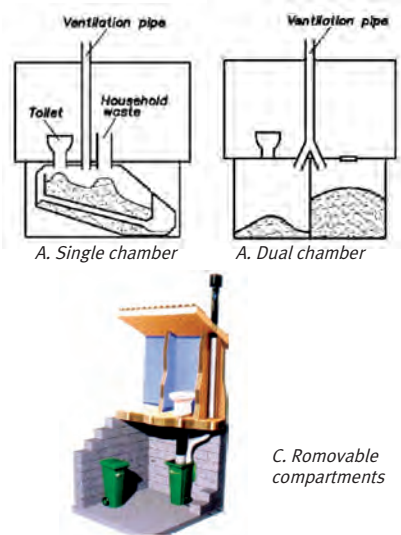

Treatment	Criteria	Comment
Storage (only treatment) at ambient temperature 2-20°C	1,5-2 years	Will eliminate most bacterial pathogens, substantially reduce viruses, protozoa and parasites, some soil-b ova may persist
Storage (only treatment) at 20-35°C	> 1 year	As above
Storage and alkaline treatment	pH > 9 during > 6 months	Temperature > 35°, moisture content > 25% or lower pH will prolong the time for absolute elimination

- ◆ The nutrients in products from CT are more readily available to plants than from dehydration toilet
- ◆ CTs can be built above GL as permanent structure without requiring deep digging of pit and periodical replacement of pits when full as in case of VIP/Pit latrines
- ◆ CT requires higher costs compared to UDD toilet in terms of excreta management
- ◆ CTs are most suitable in terms of OandM even if CTs require more care than UDD toilet in case of low tech systems

Available technologies

- ◆ Although there are many different composting toilets with different designs, the basic concept is the

same with basic two elements in any composting toilet:

- ◆ Place to sit
- ◆ Composting chamber
- ◆ Ventilation system is highly recommended in order to stimulate aeration and prevent odour
- ◆ Composting toilets can be designed either with or without urine diversion.
- ◆ Without urine diversion composting toilet needs more bulking agent to significantly lower moisture level and increase C:N ratio to attain optimum treatment conditions
- ◆ Low tech – High tech
- ◆ Single Vault (continuous) or multiple (batch)
- ◆ On-site or off-site composting
- ◆ Self-constructed or commercially produced/procured



Implementation and construction

4.1. Software components for promoting ECOSAN latrines

4.1.1. Preparatory stage of implementation

a. Awareness raising

ECOSAN systems have the overriding aim of improving public health and hygiene. However, the basic premise of ECOSAN, of closing the nutrient loop between sanitation and agriculture, means that designers of ECOSAN systems must consider a much wider range of factors than those of conventional systems. This also leads to the consideration of soil conservation, increased long-term food security, and the sustainable use of resources (in the form of nutrients, organics, water and energy). As ECOSAN aims to solve sanitation problems and ensure reuse at the lowest possible level, promoters of these systems also have to consider the active engagement of the local private sector, contributing to job creation and poverty reduction.

The phrases “awareness raising” and “public education” came into wide use in the political modernization of a number of urban environmental and governance systems in the 1990s. Another term, “social advertising”, is slightly more accurate, in that all of these terms refer to a process of public relations or propaganda for stakeholders who are outside of – or peripherally related to – the main decision-making processes. Awareness raising is often a strategy to bring these stakeholders into the process, sometimes as a counterweight to traditional or conventional institutions and experts.

Awareness raising focuses on “elevating the level of knowledge” that the users of a system have, so that they can participate in decision making at a more informed level. It is focused primarily on two kinds of communications: (1) instructions on how to use the system, comply with the rules, or change behaviour to match the needs of the system providers; and (2) information or justification about why this is necessary, desirable, morally appropriate, religiously approved,

environmentally sound, or the like. There are a number of classic formulae for awareness raising, among them the “decision-makers guides”, “key sheets”, “decision trees”, SWOT analyses, and “advantages and disadvantages” tables.

The main reason for awareness raising with regard to ecological sanitation is that the ECOSAN approach and range of alternative technical, logistical, and institutional options are at the moment relatively unknown, not only to (potential) users, but also amongst engineers, planners, decision makers, agriculturists and even sanitation professionals. The role of awareness raising is therefore to spread this knowledge and to raise the profile of ECOSAN solutions among all stakeholders, with due attention to their power in the process, their tasks, their information needs, and the ways in which this information must be presented.

The strategy of most awareness raising is to de-construct and re-construct a particular discourse about alternatives, bringing in new information, criteria, or factors which weigh differently than those in the conventional approach. In sanitation, for example, the conventional criteria have to do with microbiology, (in-house) health, and hygiene, whereas ECOSAN shifts the debate to a discussion (among others) of health and hygiene risks from contaminated surface water and insufficiently treated effluents, on water-intensivity, resource use, poverty reduction, nutrient cycles, and cultural appropriateness.

The result of bringing them into the sanitation discussion is to create a demand for comparing conventional with

new solutions, and (sometimes) creates a space for decision makers to take different decisions and support alternatives. Topics of the new discourse (for example) are:

- ◆ Participation versus top-down approaches
- ◆ Sanitation only for those who pay for it versus pro poor sanitation
- ◆ Comparing the money invested in sanitation with the gains for the national economy
- ◆ Capital cost versus labour cost and job creation
- ◆ Centralized versus decentralized
- ◆ Large infrastructure versus modest investment
- ◆ End-of-pipe versus closed loop systems
- ◆ Waste as a resource versus waste as something to be disposed of

b. Promotion of ECOSAN latrines

Promotion of ECOSAN at usually begins with educating the people on the benefits and costs of this new approach to sustainable sanitation. This may require visits to various communities that have adopted ECOSAN so that the people can see ECOSAN in operation for themselves. Once the people are convinced that ECOSAN would be good for their communities irrespective of cities/ small towns or rural areas, the next step is to make a preliminary plan and then bring that plan to the public.

Before any plan is finalized, there may be a period of further studies on different aspects of ECOSAN for different settings in the areas, such as the best ways to collect, store and utilize urine and how to transport it to farmers. Studies on alternative grey-water systems may be required.

Promotion to the public might involve meeting with smaller political units within the area to seek their feedback on the proposal and to determine what further information campaigns will be required for the public in general. Ecological sanitation systems if they are to be managed less by households, then the Households need to know how their new system works, how to use the ECOSAN devices properly and how much they need to pay.

A public education campaign needs to be designed and implemented before construction begins. Demonstration units should be built within neighbourhoods so that households can see what is coming. All sorts of civil institutions could be targeted such as men's and women's organisations, schools and religious institutions. Radio, television, newspapers and magazines can be used extensively to publicize the message.

Large-scale ECOSAN systems, however, require training at various levels:

1. Key local authorities and the people must be properly trained in the principles, technical solutions, comparative advantages and limitations of ECOSAN systems and may also need training in community empowerment methods.
2. While constructing the ECOSAN Toilets, the builders need to understand the basic principles of ECOSAN in addition to practical training in ECOSAN specific construction and installation.
3. The person responsible for collection, transport and secondary treatment must have a good understanding of sanitation-related public health, ECOSAN principles and practical issues related to ECOSAN operation and maintenance.

4. Household members must know how to operate and maintain the ECOSAN devices in their homes.

4.1.2. Socio-cultural aspects of ECOSAN

In recent years, there has been a growing realization that access to sanitation does not increase unless there is demand from the user, and as most expenditure for sanitation is at the household level, where promotional efforts are most needed here. Previous attempts to market sanitation have relied on the promotion of the health benefits that sanitation and hygienic behaviour can bring. Whilst this is clearly the most important reason for promoting sanitation and hygiene from an institutional point of view, it often proves to be much less of a motivating factor for spending money on sanitation at the individual or household level. When households contemplate a shift, other factors may prove to be a greater motivation. Research by the World Bank Water and Sanitation Programme has identified several other factors that serve to motivate even very poor households to invest in sanitation (Cairncross 2004). These include:

- ◆ Convenience and comfort
- ◆ Privacy and safety
- ◆ For women and girls, avoidance of sexual harassment and assault
- ◆ Less embarrassment with visitors
- ◆ Dignity and social status

Many sanitation projects have failed due to a poor consideration of the socio-cultural sustainability of the system. Generally projects have to realize that:

- ◆ Defecation is a highly private and intimate topic and related habits may largely differ between regions and cultures

- ◆ In some cultures handling of excreta is subject of strong taboos and may be related to aspects of human dignity
- ◆ Knowledge and perception of the reuse of excreta largely varies between cultures and regions
- ◆ Sanitation practices differ (wet versus dry hygiene, squatting versus sitting, etc.)

Problems to be addressed by projects for socio-cultural sustainable sanitation systems include:

- ◆ Household motivations to invest in sanitation
- ◆ Household expectations from the system
- ◆ Lack of awareness of hygienic risks and practices
- ◆ Traditional practices which may be wise or may pose severe hygienic risks
- ◆ The need to modify existing practices as a result of increasing urbanization in recent years

All these socio-cultural aspects have a large impact on the required design of sanitation systems, their operation, and the possible reuse of products from waste water and excreta. Therefore research is required in order to take into consideration these aspects during the preparation, implementation and operation of the sanitation systems.

Although social norms may at first complicate the introduction of innovative sanitation systems, research should concentrate on the flexibility of these systems, and determine in what way ECOSAN systems could most acceptably be introduced to society - for example after seeing the benefits through pilot/demo systems. Social acceptance is not just a simple yes or no, but a flexible parameter that changes with time.

Summarizing the above we can say that no technical sanitation solution can be successful unless it complies with the attitudes, norms and the cultural context. Social acceptance is, therefore, a major pre-requisite for promoting ECOSAN which represents a very different way of managing excreta for many people. In many societies, handling human excreta is considered to be a cultural taboo and this can be a major barrier for promoting ECOSAN. Furthermore, as flush toilets are generally associated with a modern lifestyle, most people may be hesitant towards collecting and recycling human excreta. Therefore, any programme designed to promote ECOSAN in a community should include a strong component on public awareness and community mobilization.

The term “cultural” covers a large spectrum ranging from contemporary habits and perceptions over historical heritage, religious norms, and the often unpronounceable “feelings” of the population. It is obvious that research on these viewpoints is still needed, both in general terms to allow methodologies to assess this to be developed, and in case specific studies, as each project and region has its own individual particularities, and not taking them into account may provide a false picture and lead to project failure. To allow an informed choice the decision should be based on a broad pre-selection of sanitation alternatives.

4.1.2.1. Social Marketing:

Social marketing techniques are currently seen as an extremely useful tool in promoting sanitation amongst private households. They involve the application

of commercial marketing techniques to advance social goals, in this case the safe use of excreta and grey-water through appropriate sanitation solutions. The marketing side is based on the “four Ps” - Product, Price, Place, and Promotion.

Product: Toilet and sanitary system designs must respond to what people want, rather than what sanitary engineers believe they should have.

Price: Includes all costs (monetary and non-monetary) needs to be affordable, and therefore it is necessary to offer a range of products available at different prices. This is the hardest part of selling sanitation to those who lack it. The poor, who need it most, can least afford it. Hence the need to keep costs down and market a range of products with various price tags.

Place: The product must be delivered to the right place; in particular, a toilet must be installed in the customer’s own home. This means that the supply chain has to reach every household.

Promotion: Promotion is communication with consumers about the product or service. This includes advertising, mass media, word of mouth, and anything in between. It can also include many other means to get customers’ attention and convince them to buy the product: demonstration toilets, time-limited special offers, coupons and vouchers, competitions and prizes, door-to-door sales, credit sponsored by local traders and mutual help schemes to help the poorest with the cost and the elderly with the digging.

When designing social marketing campaigns to promote sanitation and the safe use of excreta and grey-water, the possible barriers to the promotion and success of the campaign should be identified, explicitly addressed, and integrated into the campaign. With regard to sanitation Simpson-Hebert and Wood (1998) have identified 10 barriers to progress in sanitation, all of which are equally valid for the safe use of excreta and grey-water:

- ◆ Lack of political will;
- ◆ Low prestige, priority and recognition;
- ◆ Poor policy at all levels;
- ◆ Weak institutional framework and unclear distribution of responsibilities;
- ◆ Inadequate and poorly used resources;
- ◆ Inappropriate approaches;
- ◆ Failure to recognize defects of current excreta management systems;
- ◆ Neglect of consumer preferences;
- ◆ Ineffective promotion and low public awareness; and
- ◆ Women and children last.

4.1.3. Addressing gender issues

“In all societies men and women play different roles, have different needs, and face different constraints. Gender roles differ from the biological roles of men and women, although they may overlap in nearly all societies. Gender roles are socially constructed. They demarcate responsibilities between men and women, social and economic activities, access to resources, and decision making authority. Biological roles are fixed, but gender roles can and do change with social, economic, and technological change. Social factors underlie and support gender-based disparities.” (Fong, Wakeman and Bhushan 1996)

The household is the basic unit of sanitation planning, but even within the household, there are deep differences between children, women and men in terms of behaviour, preferences, power, access to resources, time spent at home, information, and skills (Khyber 1994).

Addressing gender issues in sanitation means to have a closer look at social relationships to see the different roles of community members and the complicated structure between women and men, girls and boys with regard to decision making, choice and manner of use of technology, hygiene, food security, financial security, crop production and health issues. Participation does not mean merely inviting the men from all types of households to come to a meeting and vote on toilet designs, it requires deliberate and skilled facilitation to elicit this same information from women, servants, and the social or ethnic classes who are given the “dirty work” in any particular society. The people charged with the dirty work have critical knowledge about the workings of the system, but they are frequently ignored as key stakeholders.

4.1.4. Financial aspects

The introduction of ECOSAN systems is bound to lower the total costs of urban sanitation. Conventional sewers, treatment plants and sludge disposal arrangements will cost several times as much as an ECOSAN system. ECOSAN systems require much less investment as they need no water for flushing, no pipelines for the transport of sewage, and no treatment plants and arrangements for the disposal of toxic sludge.

However, ECOSAN systems will involve costs for information, training, monitoring and follow-up that are greater than

corresponding costs for conventional on-site sanitation systems. In principle and in most cases, during the early pilot project phase, the organisation funding an ECOSAN project may need to pay the entire cost of holding workshops and courses, and building demonstration toilets, greywater systems and eco-stations. But once the project has been initiated and the local work teams have been set up along with national and international experts, the scale-up costs need to be covered by the local authorities and the users/beneficiaries.

ECOSAN systems are usually cheaper than flush toilet systems built to the same standards of quality. Experience from rural sanitation programmes around the world indicates that subsidies are often an impediment to progress in getting sanitation coverage. Either all households should be subsidized or none should be. Subsidies frequently indicate that households cannot afford to build the type of toilet that has been selected (without community involvement) by authorities from outside the community. This approach in practice, sanitation programmes involving free or highly subsidized demonstration models, are likely to fail in the long run when false expectations have been raised regarding the cost of the system. Successful sanitation relies on sound finances. In principle, households should fully repay investment and operational and maintenance costs to ensure the sustainability of the system. Furthermore, an ECOSAN system will generate economic (and ecological) value of the fertilizers produced could be significant.

ECOSAN offers a variety of options costing different amounts of money. Families should be able to select an option that they

can afford. Costs can be influenced by the type of toilet system, choice of building materials, financing arrangements, as well as whether paid labour or self-help owner constructed.

4.1.4.1. Willingness to Pay and Degree of Participation in OandM System

When adopting a demand responsive approach to sanitary provision on the basis of a freedom of choice and willingness to pay, the questions such as “whose demand?” and “whose willingness to pay?” etc. may have to be answered to address equity concerns.

“Payment” in this case may include all forms in which the users may contribute, i.e., in cash, in kind, and with time and energy for obtaining, operating, maintaining, and managing services. Also inherent in this definition is the understanding that “choice” means a lot more than technology or cost options. It can also mean who participates in which choices, i.e., which groups within the communities and households make which of the several key decisions, such as:

- ◆ initiation of the projects;
- ◆ the type of technologies and service levels;
- ◆ the location of the facilities;
- ◆ the local management, maintenance, and financing systems; and
- ◆ the candidates for training.

The “capacity to pay” can be verified through the process of facilitating for an informed choice. This is an essential requirement of the demand-responsive approach. It is not possible to assess “willingness to pay” with any accuracy in the absence of choices and full information about choices being offered

and discussed with potential consumers. Both willingness and capacity to pay can be surprisingly elastic, depending on what options are being offered, at what immediate and longer term costs, and how clearly this information is communicated to and discussed with women and men from wealthier, intermediate, and poor groups, who are all potential consumers of services. Gender-sensitive methods play an important role in assessing the overall demand for services.

In establishing demand, it is necessary and essential to investigate and control for incentives in the potential users’ environment which may distort their willingness or capacity to pay. For example, if people believe that services might be provided free of charge, they may have an incentive to say that they are too poor to pay. In such cases it may not be possible to get an accurate assessment of demand until the initial stages of project implementation are under way. At this time potential consumers can begin to see the real terms under which the services are finally being provided.

Demands and meeting demands are not static issues. Continued maintenance and use of services and user payments depend on how well the improved facilities continue to match the expectations and resources of the different groups. Users also continually compare how benefits relate to the costs of obtaining them. A close monitoring and documentation of these processes in designing and implementing the projects will provide valuable lessons for further implementation of ECOSAN systems.

4.1.5. Role of different stakeholders in promoting ECOSAN latrines

a. Women: It is particularly important that women are included in the empowerment and promotion process right from the beginning. Women are the ones normally responsible for the household water supply, sanitation, hygiene and food preparation. They generally also play a major role in the education of the children in regard to health and hygiene issues. Their views and concerns must be expressed and integrated into the programme design as well as in detailed design decisions. Special effort should be made to assure that the toilet designs take into account women's special privacy and security requirements and are ergonomically appropriate for women, men and children.

b. Key or 'model' families: No matter how effective the ECOSAN system may seem, its long-term success will depend on the credibility it enjoys with potential users. For the system to become an integral part of local culture it must first be shown to work and it must be acceptable to respected local leaders and opinion makers. A visit to a well-functioning ECOSAN toilet in a neighbour's home is one of the best ways to convert nonbelievers.

c. Local grassroots organisations: It is generally best to work through local organisations that are successful and well known within the community. Such organisations might include community water committees or health committees.

d. Local government: In the long run the support of local government will be essential for designing and installing the necessary infrastructure for supporting

ECOSAN systems on a meaningful scale. Indeed, enlightened political commitment has been perhaps the principal common critical element in the start-up of key urban ECOSAN pilot programmes, such as that in China. It can be well worth the investment to take community leaders on study tours to other communities and countries so that they can see for themselves and be convinced that ECOSAN systems do work.

e. Pilot projects: The history of technology transfer has many examples of programmes that went wrong when planners or politicians tried to go too fast without adequate attention to user participation and understanding. ECOSAN is no exception. It is advisable to begin with experimental small-scale pilot projects through which different ECOSAN devices may be assessed. During this phase the social aspects of the approach can be refined while demonstrating to a broader audience that the technology works. Broad dissemination requires in addition that hardware, if any, should be available in the market. In the pilot phase, regular follow-up at the household level is required.

4.2. Hardware components for implementation and construction

4.2.1. Components of ECOSAN latrine

a. Squatting pan

Pan is the major component of ECOSAN latrine as it diverts the urine and faeces for separate collection. The pan used in ECOSAN is quite different from the usual pan with separate holes for urine and faeces. Several types of pans are available in Nepal.

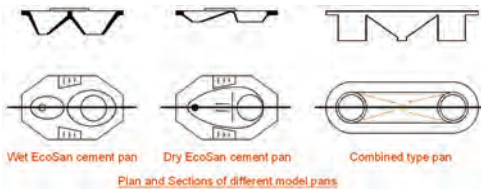
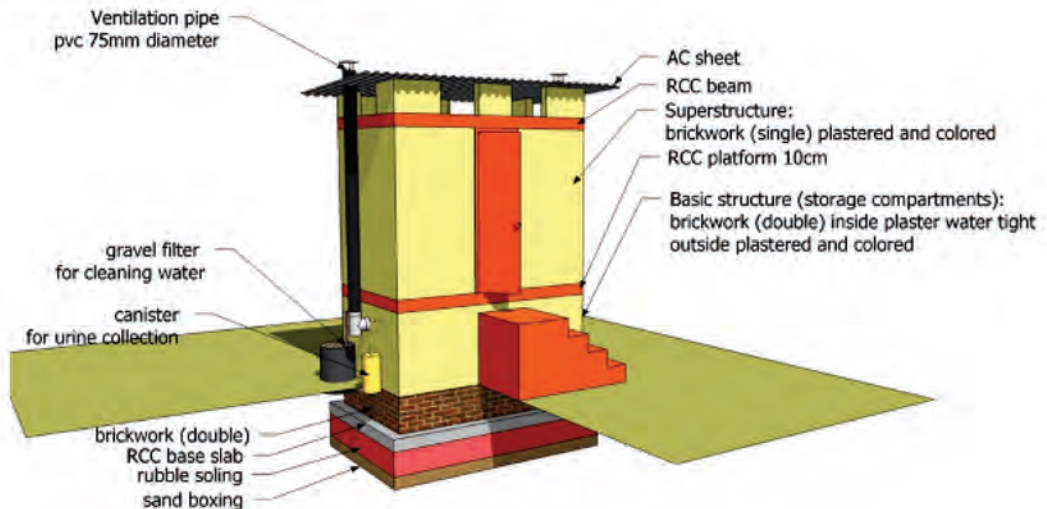

Cast in-situ type: Where especially made urine diverting pans are not available in the market, pans can be cast in-situ during construction. This is done simply by making separate holes for faeces and urine during concreting of the vault slab. This was used initially for demonstrating ECOSAN when especial ECOSAN pans were not available in the market but this is rarely used these days as it is now easier buy an ECOSAN pan.

- i. **Dry ECOSAN cement pan:** This was by designed with the help of local mason and it looks like the ordinary pan. This is popular among the users.
- ii. **Wet ECOSAN cement pan:** This type of pan is similar to the dry ECOSAN

cement pan but it is slightly larger and designed so as to facilitate flushing of the faeces with water.

- iii. **Fibre glass pan for dry ECOSAN:** This is similar to the dry ECOSAN cement pan but as it is made of fibreglass it is lighter and looks more attractive.
- iv. **Fibre glass pan for wet ECOSAN:** This is similar to the wet ECOSAN cement pan but as it is made of fibreglass it

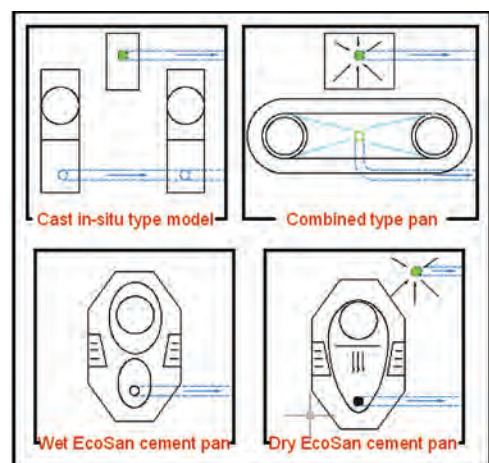

is lighter and looks more attractive. The fibre glass pans for wet and dry ECOSAN are currently made by a manufacturer in Kathmandu.

- v. **Combined type pan:** In this type of pan, there are two holes for faeces and one hole for urine. This type of pans is made of cement as well as PVC.

b. Pan cover

Pan cover is used in a dry ECOSAN to cover the hole in the pan leading to the vault to prevent fly breeding and avoid water getting into the vault. It also helps in controlling odour from vault. The lids may be made of cement, metal, PVC and plastic. A small hook can be used to open and close the lid.

c. Faeces collection tank (vault/chamber)

The faeces collection tank or vault is designed for a HH size of 6. It is generally constructed above the ground. There may be one or two vaults in a dry ECOSAN. In a single vault ECOSAN, a plastic container is placed inside the vault to collect faeces.

d. Vent pipe

The vent pipe is made of polythene or PVC and has a diameter of 75mm with cowl on top. It is provided for air circulation inside the faeces chamber in order to reduce odours inside the latrine. The vent pipe should rise above the roof level of latrine.

e. Urine pipe network and collection tank

The urine pipe consists of a 50 mm diameter PVC pipe. It is connected to the urine collection tank from urine diversion hole of pan. Urine pipe should be concealed into the PCC of the chamber cover for safety. Urine collection tank is usually a plastic container of 100 liters capacity. It must have air tight cover to

prevent the loss of nutrient in the urine. In the container, the urine pipe should be dipped in the urine up to one fourth the container height in order to avoid splashing of urine and odour problems.

f. Faeces emptying door

Each faeces vault should have an opening for emptying the vault. The size of opening should not be less than 30 cm in length and breadth. Concrete slab, slate, wooden planks, or transparent PVC sheet can be used for shutting the opening.

4.2.2. Types of ECOSAN latrines

Dehydration (Dry) ECOSAN latrines:

- a. **Double vault ECOSAN:** This latrine has two vaults each having capacity of 0.3 m³, above the ground level for faeces collection. Each vault has a length of 3 feet 4 inches, width of 2 feet and height of 2 feet, and each has an opening of 12x12 inches in the back side for emptying the faeces. In this type of ECOSAN, one vault is used for a period of approximately six months. Once it is filled, the second one is used, while the first one is left untouched for dehydration. Once the second vault is also filled, the first vault is emptied and reused. The contents of the first vault is

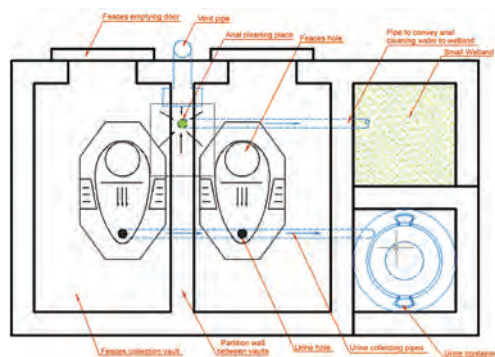

then further composted or applied directly in the fields. The vaults are thus used alternatively every six months. The vaults are constructed above the ground level to avoid ground water seepage and have a 4 inch thick brick masonry wall. Vaults are separated by 4 inch partition wall.

Outside of latrine there is urine collection tank (usually a 100 liter plastic tank) and a small wetland for the treatment of anal cleaning water.

- b. *Two vault solar model:* Two vault solar model ECOSAN is very similar to the double vault ECOSAN described previously. The only difference is that the vaults of faeces are designed slightly bigger and they extend beyond the wall of the latrine. The opening of the vaults face south and have an inclined shape with a black metal or fiber sheet as cover to capture solar heat so as to assist in the drying the faeces.

- c. *Single vault-bucket ECOSAN:* Single vault-bucket ECOSAN is similar to the double vault ECOSAN, except it only has one pan and a single vault or bucket to collect the faeces. This type of ECOSAN may be useful when there is not enough land to construct a double vault ECOSAN latrine. The size of the single vault will vary according to the available space. The vaults of this type of ECOSAN latrines built in Siddhipur had an internal dimension of 3'-4" x 3'-4" and the height varied. The vault has 4 inch thick brick masonry wall and a wide door in the backside wall. In this type ECOSAN, faeces is collected in a bucket placed on a trolley inside the vault. When the bucket is filled, it is replaced by new bucket. The bucket of faeces is covered and left for at least six months before it is used as a soil conditioner.

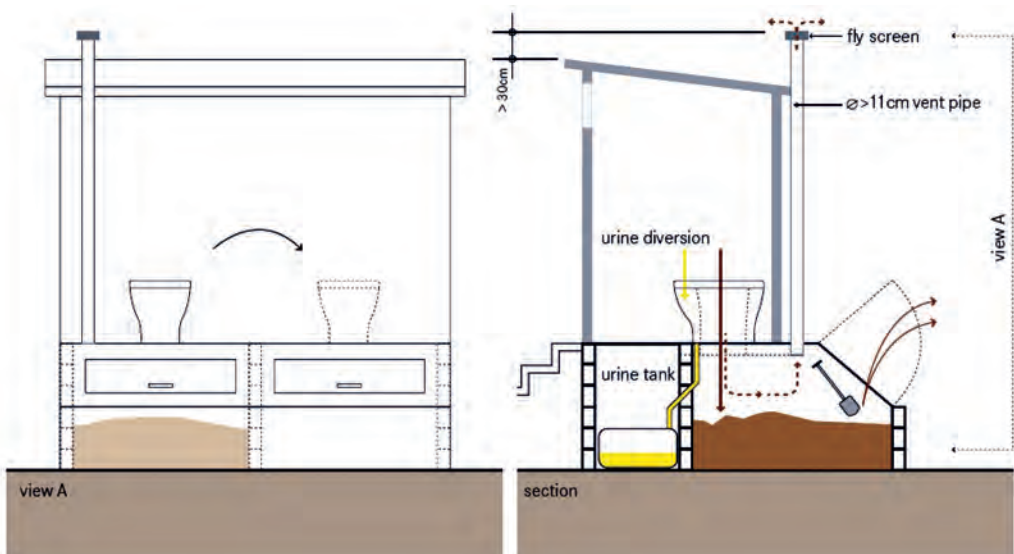

Dehydration vaults: Dehydration vaults are used to collect, store and dry (dehydrate) faeces. Faeces will only dehydrate when the vaults are watertight to prevent external moisture from entering and when urine and anal cleansing water are diverted away from the vaults.

When urine is separated from faeces, the faeces dry quickly. In the absence of moisture, organisms cannot grow and as such, smells are minimized and pathogens are destroyed. Vaults used for drying faeces in the absence of urine have various local names. One of the most common names for this technology is the Vietnamese Double Vaults.

A family of 6 will produce 500L of faeces in approximately six months. For design purposes it is recommended to assume that one person will require almost 100L of faeces storage space every six months. The vaults should be slightly oversized to account for airflow, visitors and the non-even distribution of faeces in the chamber. Each vault is sized to accommodate six months of faeces accumulation which in turn, results in a six month drying time in the out-of-service vault.

Two alternating vaults allow the faeces to dehydrate in one vault while the other vault fills. When one vault is full it is sealed with a lid and the UDDT is moved to the second vault. While the second vault fills up, the faeces in the first vault slowly dry and decrease in volume.

When the second vault is full, it is sealed, the dry material from the first vault is removed and the first vault is then put back into service.

The vaults must be watertight to keep the faeces as dry as possible. Chambers should be constructed of sealed block or formed concrete to ensure that rainwater, surface run-off, grey-water and urine are prevented from entering the vaults. Urine can be collected in a bucket and discharge to the ground (garden) or stored in a tank for future transport and use.

A vent is required to help keep the vaults dry and control flies and odours.

Adequacy: Dehydration Vaults can be installed in almost every setting from rural to dense urban because of the small land area required, the minimal odours and the ease of use. They are especially appropriate for water scarce and rocky areas. In areas that are frequently flooded, Dehydration Vaults are appropriate because they are constructed to be watertight. Furthermore, where there is no plot of land available, the vaults can be installed indoors, which also makes this technology applicable for colder climates (where leaving the house is less desirable).

Health Aspects/Acceptance Dehydration Vaults can be a clean, comfortable, and easy-to-use technology.

When users are well educated and understand how the technology works they may be more willing to accept it as a viable sanitation solution.

When the vaults are kept dry, there should be no problems with flies or odours. Faeces from the double vaults should be very dry and relatively safe to handle provided they were continuously covered with material and not allowed to get wet.

There is a low health risk for those whom have to empty or change the urine container. Faeces that have been dried for over one year also pose a low health risk.

Upgrading There is a risk however when using single vaults, that the top portion of the faeces will not be fully dried and/or hygienic. Single vaults are not recommended (because of the need to handle fresh faeces) and should, whenever possible be upgraded to a double vault.

Maintenance To prevent flies, minimize odours and encourage drying, a small amount of ash, soil, or lime should be used to cover faeces after each use. Care should be taken to ensure that no water or urine gets into the Dehydration Vault. If this happens, extra soil, ash, lime, or sawdust can be added to help absorb the liquid.

Because the faeces are not actually degraded (just dried), dry cleansing materials must not be added to the Dehydration Vaults as they will not decompose. Occasionally, the mounded faeces beneath the toilet hole should be pushed to the sides of the pit for an even drying.

Where water is used for cleansing, an appropriate User Interface should be installed to divert and collect it separately. To empty the vaults, a shovel, gloves and possibly a face mask (cloth) should be used to limit contact with the dried faeces.

Urine diversion wet (twin pit pour flush) latrines:

- a. *Urine diverting double pit latrine:*
This type of latrine is similar to a pour flush double pit latrine, except it has a separate system for collecting urine.

Typically, there are two pits made of concrete rings for collecting the faeces and wastewater and the capacity of a single pit is designed for 2 years. As in dry ECOSAN the pits are used alternatively. Urine is collected in a container fixed outside of latrine. Currently, this type of latrine is being promoted in the Terai area of Nepal where water availability is not a major problem.

- b. *Biogas attached latrine:* The biogas attached latrine recycles human excreta, along with other types of waste such as cattle dung, to produce biogas, which can be used for cooking and lighting and slurry that can be used for composting. Currently there are about 100,000 latrine attached biogas plants in Nepal. Almost all of these are fixed dome type plants with capacities of 4, 6, 8 or 10 m³. The ordinary biogas attached latrine can be slightly modified by replacing the pan in the latrine with a urine diverting ECOSAN pan to collect urine separately and send only the faeces along with the flush water and anal cleaning water to the biogas digester.

4.2.3. Construction details and other important information

A list of suitable building materials is given below:

- ◆ **processing compartments:** natural stone masonry, bricks, cement concrete solid blocks, cement concrete hollow blocks, solid blocks made from locally available rock (e.g. Laterite, etc.), etc.
- ◆ **removeable cover:** steel sheets, FRP sheets, cement concrete slabs, etc.
- ◆ **squatting slab:** reinforced cement concrete, etc.

- ◆ **cubicle:** natural stone masonry, bricks, ferro-cement slabs, cement concrete solid blocks, cement concrete hollow blocks, solid blocks made from locally available rock (e.g. Laterite, etc.), corrugated sheet metal, etc.
 - ◆ **ventilation system:** stone-ware pipes, plastic pipes, etc.
 - ◆ **urine and wash water collection system:** flexible hoses, rigid plastic pipes, etc.
 - ◆ **roofing:** corrugated cement sheets, corrugated sheet metal, Mangalore tiles, cement concrete slab, stone slab, etc.
 - ◆ **Processing compartments** shall be **sealed** (either by removable concrete slabs or lockable covers) to prevent rainwater and insects from entering the compartments.
 - ◆ The **bottom slab** of the processing chamber shall be **raised about 10 cm above** the surrounding **ground level** to prevent flood water from entering the compartment.
 - ◆ Plaster has to be applied to inner walls and the bottom slab to provide a smooth surface.
 - ◆ Squatting pans must either have a rim or be raised ca. 2 cm above the finished floor level of the latrine to prevent water used for cleaning the latrine from entering both, the processing compartments and the urine collection system.
 - ◆ Squatting pans/pedestals have to be provided **tight fitting covers** to prevent insects from entering the processing compartments.
 - ◆ Inner and outer wall areas of cubicles may be left as rough walls (without plastering). But, inner wall areas should be tiled up to a height corresponding to 60 cm from the finished floor level for ease of cleaning.
 - ◆ Each processing compartment must be provided a **straight ventilation pipe** ($\varnothing \geq 150$ mm) that **runs above the roof** (at least 50 cm), is **screened** against flies and **capped** for rain.
 - ◆ To avoid leakiness of the roof in rainy season, the vent pipes shall not be installed inside the cubicle but be attached to the outside wall for not penetrating the roofing.
 - ◆ Urine shall be drained to **sealed receptacles** (jerry can, transportable plastic tank, etc) which may be stored out-side the latrine.
 - ◆ Use **corrosion resistant material (plastic) for urine pipes, provide for proper diameter** ($\varnothing \geq 50$ mm) and **slope** ($\geq 4\%$) to avoid stagnation (reduces smell and slows down incrustation by crystallisation), **extend urine pipe to ca. 3" above bottom of receptacle.**
 - ◆ If wet anal cleansing habits should prevail in a community, **cleansing water must be diverted from faecal matter** for practical reason. Cleansing water may either be used for subsurface irrigation of nearby plants or being disposed off by infiltration into the soil.
- #### 4.2.4. Guidelines for construction
- ##### *Site selection and layout of latrine*
- ◆ Easy but important step.
 - ◆ One needs to consider the position of emptying hole, urine container and effective use of space.
 - ◆ Better to orient the emptying hole at the backside of entrance and allocate adequate space for emptying.
- ##### *Foundation work*
- ◆ Excavation is done for wall foundation. 12" inches wide and 18" depth trench is excavated for foundation wall.

Brick work and PCC work for chamber



Slab with squatting pan

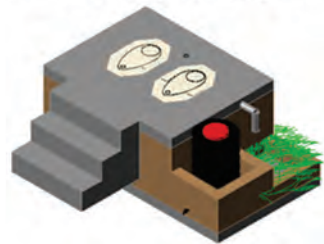

Piping System

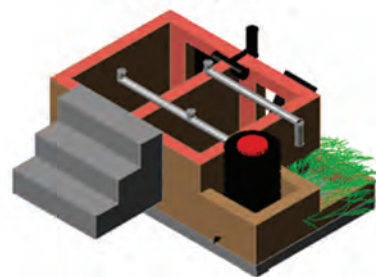

- ◆ Dry brick soling is done and brickwork for wall is started.
- ◆ Wall should rise up to 6" above existing ground level to insure flooding of water into the vault during rain.
- ◆ Concrete Platform of 4" thick (PCC) is constructed.
- ◆ Typically 4" brick wall is preferred for chamber construction which should be started after setting of platform chamber.
- ◆ Chamber is divided into two vaults by a 4" wall partition (if it is double vault, otherwise no need to partition the chamber for single vault).
- ◆ Height of chamber is generally 2 feet.
- ◆ Upon completion of wall construction internal face of wall is plastered and punning is done to reduce possibility of water seepage.
- ◆ Finally concreting of slab is casted over the chamber with pan.

Superstructure work

- ◆ After concrete slab casted over the chamber (vault) is set (normally takes 2 – 3 weeks at maximum), construction of superstructure for the latrine should then be started. The superstructure is similar to an ordinary latrine.

Implementing organisation	Size of processing chambers		
	length [m]	width [m]	height [m]
PEO/PPDO/GTZ (Philippines)	ca. 1.65 to 2.30 (sloping cover)	ca. 0.60	ca. 0.80
Practical Action (Sri Lanka)	ca. 0.90	ca. 0.60	0.60 to 0.75
ECOSAN Services Foundation (India)	ca. 1.15	ca. 0.60	ca. 0.60
ENPHO (Nepal)	ca. 1.00	ca. 0.60	ca. 0.60
SCOPE (India)	ca. 1.30	ca. 0.75	ca. 0.60



Plumbing work

- ◆ Final work of latrine is plumbing i.e. urine container, vent pipe, black water pipe etc fitting works.
- ◆ Pipe to convey urine and anal wash water is concealed in slab where as Tee for the vent pipe is fitted just under the slab.
- ◆ Pipe fitting work is more sensitive and it requires proper care to ensure that the pipe does not move during the casting of the slab. Otherwise it makes leakage of into the chamber and creates more difficulties to maintain. Therefore, plumber must be careful to control leakage but should be concealed.
- ◆ Soak pit for constructed wetland to treat black water from latrine: Generally at the side of urine container, a soak pit or constructed wetland for the waste water is constructed.
- ◆ The pit should be 12 inches deep and filled with layer of aggregate or brick

ballets in bottom and coarse sand layer at the top.

4.2.5. Quantity estimation for an ECOSAN latrine

One of the most common criticisms faced by ECOSAN promoters is that the latrine is expensive. No doubt, there is a cost associated with building structures that can separately collect and store faeces and urine properly; ECOSAN latrines do cost more than simple pit latrines. However, one needs to understand that ECOSAN is more than a latrine; it is a latrine as well as a treatment or recycling system. In this context, the cost of ECOSAN is significantly less than other latrines and treatment systems.

The construction cost associated with ECOSAN can vary from place to place depending materials used, designs adopted and fluctuations in market place. Overall the construction cost can be divided into two parts: (a) Substructure (up to Pan Level) construction and (b) Superstructure construction

Substructure (up to pan level) construction:

This includes two vaults for faeces storage, a urine storage tanks and two pans in case of dry ECOSAN. As the price rate of the materials required for the construction of an ECOSAN latrine differs from one place to another, therefore, only quantity estimates has be broken down as follows. The provided quantities when multiplied by unit rate give the cost of the materials. The sum total of all the material cost required for an ECOSAN latrine gives the cost for an ECOSAN Latrine. The quantity estimates for constructing ECOSAN up to its pan level is presented in **Annex – 2(A)**.

From the experience of promotion of ECOSAN latrines in Nepal, it was observed that the subsidy amounting approximately 60 % of the total costs was normally provided. The provision of subsidy has definitely been instrumental in generating demand even when the technology is relatively new and most people are either not aware of it or still not confident enough about its application and benefits. As people become more aware about the benefits of the technology, the subsidy should be gradually reduced or replaced by provision of low interest loans through revolving funds.

Superstructure (above pan level)

construction: This is almost the same as for any other latrine and this cost will vary significantly depending on the materials used for building the walls and roofing.

The average cost of a dry double vault ECOSAN latrine with brick and cement superstructure in Kathmandu Valley is approximately Rs. 20,000 (US\$ 250). The comparison of cost for ECOSAN latrine and other latrines is presented below in **Annex – 2(B)**.

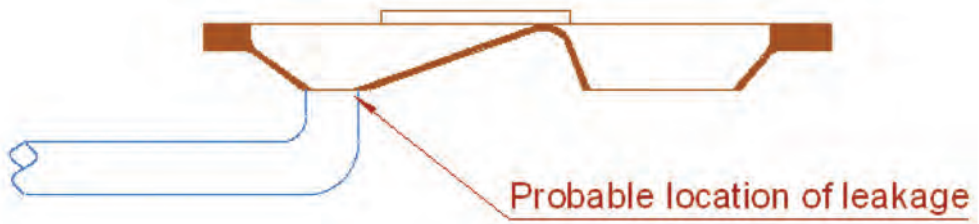



Common problems and trouble shooting; potential problems and constraints; dos and don'ts

5.1 Common problems and trouble shooting

1. Leakage of urine through the joint between pan and urine pipe:

Urine leakage can be a problem in an ECOSAN toilet. Masons must be careful during construction, specially casting of slab, to ensure that the joint between pan and urine pipe is fitted properly. If such problem occurs, cement putting can be applied at the urine hole.

2. Water enters into the faeces chamber during toilet cleaning: In the dry ECOSAN, the faeces vault needs to be kept as dry as possible to assist in the dehydration of the faeces and accelerate the die-off rate of pathogens in the faeces. However sometimes, water may enter the vault through the pan, through the vault opening or seepage from the walls or ground. The following measures should be taken to prevent water entering the vault:

- ◆ The pan should be raised slightly (about 1cm) above the floor
- ◆ Special care needs to be taken while cleaning the toilet to avoid water from getting in the vault
- ◆ Users, especially guests, should be instructed not to put water in the vault
- ◆ The vault opening should be tightly closed
- ◆ If water does get into the faeces vault, some more ash or other dry materials should be put in the vault to assist in the absorption of the water.

3. Smell of urine inside the toilet: When urine is collected, it is important to store it in such a way to prevent odours and loss of nitrogen to the air. The loss on nitrogen to the air can be minimized by storage in a covered container with restricted ventilation, however this can create odour problem inside the toilet. Following measures should be taken to minimize the odour of smell inside the toilet:

- ◆ The end of urine collection pipe should be inserted below the lowest level of urine collected in the container
- ◆ After each urination, small amount of water should

4. Urine collection pipe gets blocked: If inadequate slope is provided to urine collection pipe, there is a chance of urine getting crystallized blocking the flow of urine. To prevent this problem, pipe should be placed with proper slope and during casting of slab care should be taken that the pipe does not move.

- ◆ Excavation of dried faeces is easier than faecal sludge
- ◆ No real problems with flies or odours if used correctly
- ◆ Does not require a constant source of water
- ◆ Suitable for all types of user (sitters, squatters, washers and wipers)
- ◆ Low (but variable) capital costs depending on materials; no/low operating costs
- ◆ Small land area required
- ◆ Requires education and acceptance to be used correctly
- ◆ Requires constant source of ash, sand or lime
- ◆ Requires a use/discharge point for urine and faeces
- ◆ Urine and faeces require manual removal

5.2 Potential problems and constraints

- ◆ Can be built and repaired with locally available materials
- ◆ Because double pits are used alternately, their life is virtually unlimited
- ◆ Good in rocky and/or flooded areas

5.3 Dos' and don'ts with ECOSAN latrines





TOO CLOSE TO FENCE



VENT PIPE DIA. OK. STRAIGHT, RUNS ABOVE ROOF, SCREENED & CAPPED



COVER MATERIAL & WASTE BIN FOR DISPOSAL OF TOILET PAPER



URINAL FOR MALES. SOAP & WASH BASIN ARE PROVIDED



VENT PIPE TOO SHORT



INPROPER DISCHARGE OF GREYWATER & CLEANSING WATER



TOO SMALL DIAMETER & TOO MANY BENDS



PROPER DIAMETER & SLOPE OF PIPE OF URINE COLLECTION PIPE



POOR DESIGN OF SLOPING COVER ALLOWING RAINWATER TO ENTER PROCESSING CHAMBERS



PIPE TOO SHORT (SHOULD END ABOUT 3" ABOVE BOTTOM)



DIAMETER TOO SMALL

References

- Briscoe J and Steer A (1993) *New approaches to structural learning*. Ambio 22 (77): 456 and WHO, Environmental Health Newsletter 27 (Supplement, 1997)
- Del Porto D and Steinfeld C (1997) *The Composting Toilet System Book*. Concord, Mass.: Center for Ecological Pollution Prevention
- Esrey S A Gough J, Rapaport D et al (1998) *Ecological Sanitation*. Stockholm: SIDA
- Esrey S A (2000) *Rethinking Sanitation: Panacea or Pandora's Box*. In: Chorus I, Ringelband U, Schlag G and Schmoll O (eds), Water, Sanitation and Health, International Water Association, London
- Feachem R G, Bradley D J, Garelick H et al (1983) *Sanitation and Disease: Health Aspects of Excreta and Wastewater Management*. New York: John Wiley and Sons
- GTZ (2005) *Urine diverting dry toilets programme dissemination (data sheet), GTZ, Germany*. Available: www.gtz.de (General overview of Dehydration Chambers with some dimensioning and materials lists)
- Guadarrama R O (2000) *Human urine used as a source of nitrogen in the production of organic crops, in Cuernavaca, Morelos, México: a case study*
- Jönsson H (1997) *Assessment of sanitation systems and re-use of urine*. In: Drangert J-O, Bew J, and Winblad W, Ecological Alternatives in Sanitation, Proceedings from SIDA Sanitation Workshop, Balingsholm, Sweden
- Jönsson H, Stenström T-A and Sundin A (1997) *Source separated urine, nutrient and heavy metal content, water saving and faecal contamination*. Wat. Sci. Tech. 35(9): 145-152

Kabir Rajbhandari (2008) *Ecological Sanitation Latrines: The Experience of Nepal. Beyond Construction: Use by all – A collection of case studies from sanitation and hygiene promotion practitioners in South Asia.* WaterAid, IRC and WSSCC

Manual del Sanitario Ecologico Seco. Available: www.zoomzap.com
(A very comprehensive manual on dry chamber construction including detailed instruction and material lists. In Spanish.)

Morgan P (1999) *Ecological sanitation in Zimbabwe – an overview.* Paper presented at the International Workshop, Ecological Sanitation – Closing the Loop to Food Security, 17-21 October 1999, Cuernavaca Mexico

Raloff J (1998) *Drugged waters: does it matter that pharmaceuticals are turning up in water supplies?* Science News 153: 187-189

Stenström T-A (1999) *Health security in the re-use of human excreta from on-site sanitation.* Paper presented at the International Workshop, Ecological Sanitation – Closing the Loop to Food Security, 17-21 October, 1999, Cuernavaca Mexico

Stockholm Vatten et al (2000) *Urinsortering – en del av kretsloppet.* Stockholm: Byggforskningsrådet

WaterAid (2008) *A Report on “Assessment of Urine Diverting ECOSAN Toilets in Nepal.* www.nepal.wateraid.org

Winblad U and Simpson-Herbert M (eds) (2004) *Ecological Sanitation - revised and enlarged edition. SEI, Stockholm, Sweden.* (A general description of various designs and adaptations, especially Chapter 3)

Wolgast M (1993) *Rena vatten - om tankar I kretslopp.* Uppsala, Sweden: Creanom HB

Women in Europe for a Common Future (2006) *Urine diverting Toilets: Principles, Operation and Construction.* Available: www.wecf.de (Photos and explanation of how to build a double vault and superstructure)

World Health Organisation and United Nations Children’s Fund (2000) *Global water supply and sanitation assessment 2000 Report.* Geneva: WHO and UNICEF

Annex: 1

Sample drawings of ECOSAN latrines

Module: "Urine-Separation Vermitoilet"

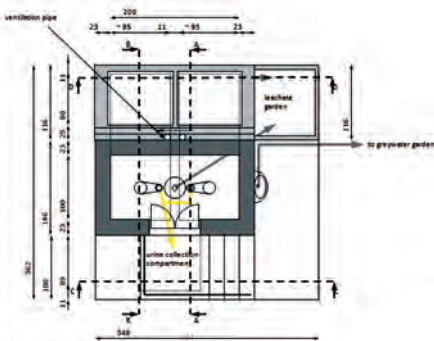

Module "Urine-Separation Vermitoilet" (cont.)

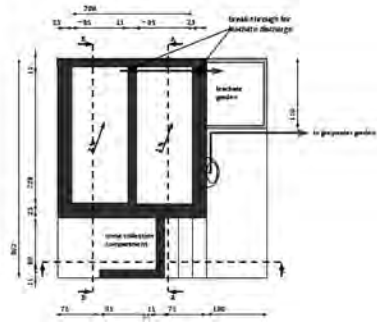

Module "Urine-Separation Vermitoilet" (cont.)

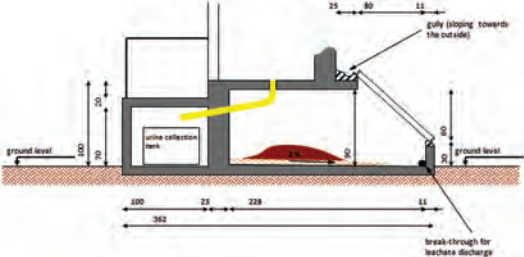

Detail processing Chamber

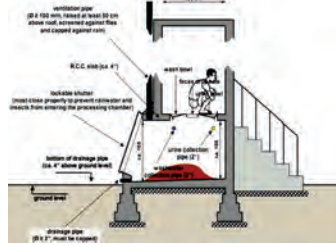
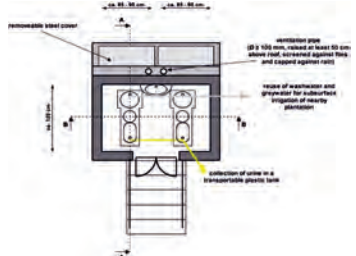
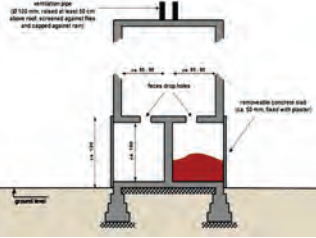
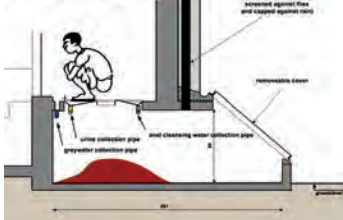

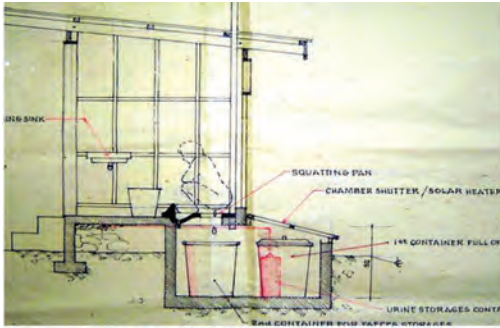

Dehydration toilets with movable bins, Bohol, Philippines



Double-vault dehydration toilets, Bohol, Philippines

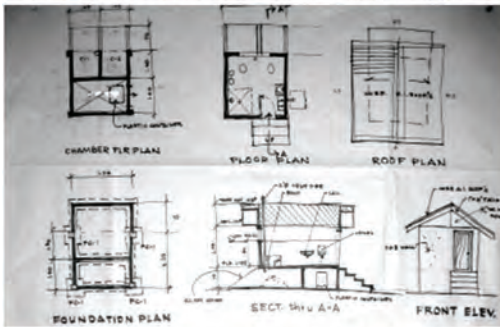

Double-vault dehydration toilets, Bohol, Philippines

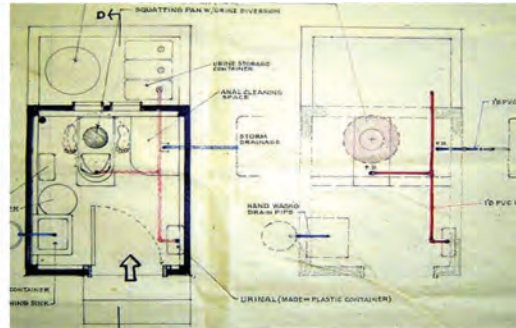
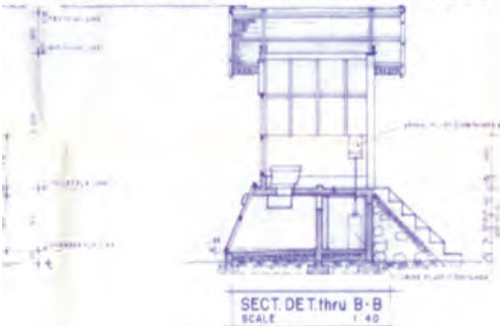

Dehydration toilets with movable bins, Bohol, Philippines

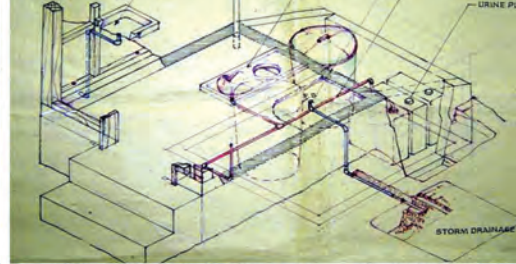

Double-vault dehydration toilets, Bohol, Philippines



Double-vault dehydration toilets, Bohol, Philippines

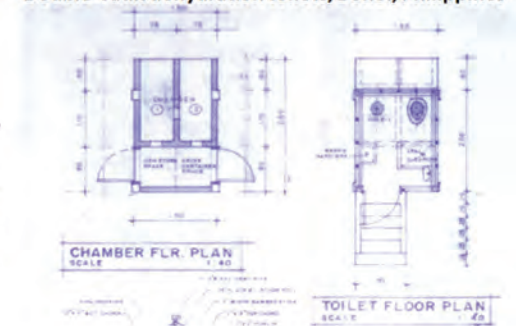

Annex: 2a

Comparison of cost between ECOSAN and other latrines

S.N.	Description	Toilet with septic tank	Twin pit sulabh	Single pit sulabh	Flush toilet with modern treatment facilities	Flush toilet with reed bed treatment facilities	ECOSAN toilet	Remarks
1	Individual Toilet Cost	6,000	6,000	6,000	6,000	6,000	16,000	
2	Septic Tank and Soakage Pit	12,000	6,000	3,000				
3	Sewer Line				12,000	12,000		@ 2000 per capita assuming average HH size is 6
4	Treatment Plant cost				3,000			@500 per capita excluding land cost
5	RBT Treatment plant cost					11,000		@11000 per family excluding land cost
6	Operation Cost (Basically for desludging)	600	200	300	300	60	200	@ 50/capita/year in modern treatment and 10/capita/year for RBT
8	Maintenance cost	186	140	100	250	300	185	@1% maintenance cost for all types of facilities
9	Monetary value of Urine and Faeces	No	Low	Low	No	Low	2,100	Extracted from financial analysis of ECOSAN Toilet
	Total	18,786	12,340	9,400	21,550	29,360	14,285*	*[(sum of 1 to 8) – (9)]
10	Fertilizer Value	No	Low	Low	No	Low	High	Note: All the amount is expressed in Nepalese currency
11	Water Requirements	High	Medium	Medium	High	High	Low	
12	Risk of GW Pollution	Medium	High	High	No	No	No	

Source: Assessment of ECOSAN Latrines in Nepal, WaterAid and ENPHO, 2006

Annex: 2b

Materials for double vault dry ECOSAN latrine up to pan level

S.N.	Description of work	Quantity	Unit	Price Rate	Amount
1	Bricks	650	bag		
2	Cement	5	cuft		
3	Sand	35	cuft		
4	Aggregate	15	cuft		
5	MS bar	10	kg		
6	Mason	6	nos		
7	Pan	2	nos		
8	Pipe and Fittings				
	* 3" Poly bend	1	nos		
	* 3" Poly tee	1	nos		
	* 3" Poly cowl	1	nos		
	* 3" Poly pipe	6	rft		
	* 2" PVC tee	1	nos		
	* 2" PVC bend	3	nos		
	* 2" PVC net cap	3	nos		
	* 2" PVC pipe	1	rm		
	* 1/2" GI nipple	2	nos		
	* 1/2" GI socket	1	nos		
	* Plastic tap	1	nos		
	* 100 liter plastic container	1	nos		
				Total	



WaterAid transforms lives by improving access to safe water, hygiene and sanitation in the world's poorest communities. We work with partners and influence decision-makers to maximise our impact.

For more information, please contact:

WaterAid in Nepal

Kupondole, Lalitpur, Nepal

GPO Box: 20214, Kathmandu, Nepal

Telephone: + 977 1 5552764/ 5552765/ 5011625

Fax: + 977 1 5547420

Email: wateraidnepal@wateraid.org

www.nepal.wateraid.org