

RESOURCE RECOVERY & REUSE SERIES 2

2

Technological Options for Safe Resource Recovery from Fecal Sludge

Josiane Nikiema, Olufunke Cofie and Robert Impraim



About the Resource Recovery and Reuse Series

Resource Recovery and Reuse (RRR) is a sub-program of the **CGIAR Research Program on Water, Land and Ecosystems (WLE)** dedicated to applied research on the safe recovery of water, nutrients and energy from domestic and agro-industrial waste streams. This sub-program aims to create impact through different lines of action research, including (i) developing and testing scalable RRR business models, (ii) assessing and mitigating risks from RRR for public health and the environment, (iii) supporting public and private entities with innovative approaches for the safe reuse of wastewater and organic waste, and (iv) improving rural-urban linkages and resource allocations while minimizing the negative urban footprint on the peri-urban environment. This sub-program works closely with the World Health Organization (WHO), Food and Agriculture Organization of the United Nations (FAO), United Nations Environment Programme (UNEP), United Nations University (UNU), and many national and international partners across the globe. The RRR series of documents present summaries and reviews of the sub-program's research and resulting application guidelines, targeting development experts and others in the research for development continuum.



IN PARTNERSHIP WITH:



RESOURCE RECOVERY & REUSE SERIES 2

Technological Options for Safe Resource Recovery from Fecal Sludge

Josiane Nikiema, Olufunke Cofie and Robert Impraim

The authors

Dr. Josiane Nikiema holds a Master's and a PhD in Chemical Engineering for design and optimization of processes. She is adjunct professor in Chemical and Civil Engineering at the Université de Sherbrooke in Canada and is a Researcher - Environmental Sciences based at IWMI's West Africa Office in Accra, Ghana. j.nikiema@cgiar.org

Dr. Olufunke O. Cofie is a senior researcher with a background in soil science. She is Head of IWMI's West Africa Office in Accra, Ghana, and worked over the past 14 years in the interface of sanitation and agriculture. o.cofie@cgiar.org

Mr. Robert Impraim holds a master's in Crop Science and is a Junior Research Officer - Recycling and Reuse at the IWMI-Ghana office. r.impraim@cgiar.org

Nikiema, J.; Cofie, O.; Impraim, R. 2014. *Technological options for safe resource recovery from fecal sludge*. Colombo, Sri Lanka: International Water Management Institute (IWMI). CGIAR Research Program on Water, Land and Ecosystems (WLE). 47p. (Resource Recovery and Reuse Series 2). doi: 10.5337/2014.228

/ faecal coliforms / sewage sludge / waste treatment / excreta / resource management / recycling / organic wastes / soil fertility / water quality / gravity flow / filtration / composting / dewatering / nutrients / sanitation / wetlands / case studies /

ISSN 2478-0510
e-ISSN 2478-0529
ISBN 978-92-9090-804-3

Copyright © 2014, CGIAR Research Program on Water, Land and Ecosystems, International Water Management Institute (IWMI).

Unless otherwise noted, you are free to copy, duplicate or reproduce, and distribute, display, or transmit any part of this paper or portions thereof without permission, and to make translations, adaptations or other derivative works under the following conditions:

ATTRIBUTION. The work must be attributed but not in any way that suggests endorsement by WLE or the author(s).

NON-COMMERCIAL. This work may not be used for commercial purposes.

SHARE ALIKE. If this work is altered, transformed, or built upon, the resulting work must be distributed only under the same or similar Creative Commons license to this one.

Front cover photograph: IWMI

Editor: Robin Leslie
Designer: Michael Dougherty

Acknowledgements

This report is based on research funded in part by the Bill & Melinda Gates Foundation, UK Department for International Development (DFID), Grand Challenges Canada, African Water Facility (AWF)/African Development Bank (AfDB), French Ministry of Foreign Affairs, Swiss National Centre of Competence in Research (NCCR) North-South, and Zweckverband Kehrichtverwertung Zürcher Oberland (Waste Disposal Services Zürcher Oberland) (KEZO) in Switzerland. The findings and conclusions contained within are those of the authors and do not necessarily reflect positions or policies of the funders.

The International Water Management Institute (IWMI) would like to thank the following research and development partners for their direct and indirect support towards the research conducted in relation to this publication: Department of Water and Sanitation in Developing Countries (SANDEC) of the Swiss Federal Institute of Aquatic Science and Technology (EAWAG), Dübendorf, Switzerland; Waste management departments of the cities of Kumasi, Tema and Sekondi Takoradi, all in Ghana; Council for Scientific and Industrial Research - Water Research Institute (CSIR-WRI), Accra, Ghana; Biotechnology and Nuclear Agriculture Research Institute (BNARI), Accra, Ghana; Rapha Consult, Accra, Ghana; and the University of Ghana, Valley View University (VVU) and Kwame Nkrumah University of Science and Technology (KNUST), all in Ghana.

The authors are also grateful to Dr. Pay Drechsel, Dr. Philip Amoah, Dr. Surendra Pradhan (all at IWMI) and Mr. Moritz Gold (EAWAG, Dübendorf, Switzerland) for providing comments on the document; and to Mrs. Christine Müller (Bioburn), Mr. Fredrik Sunesson (Slamson Ghana Ltd.) and Mr. Massimo Zanette (Particle Separation Systems) for providing data included in this report.



CONTENTS

LIST OF TABLES	vi
LIST OF FIGURES	vii
ACRONYMS AND ABBREVIATIONS	viii
SUMMARY	ix
1 INTRODUCTION	1
2 CHARACTERIZATION OF FECAL SLUDGE	1
3 RECOVERY OF SOLIDS FROM LIQUID FECAL SLUDGE	2
3.1 Generalities	2
3.2 Thickening Systems	3
3.2.1 Most Common Process: Gravity Thickener	4
3.2.2 Possible Additional Processes	5
3.3 Dewatering Systems	6
3.3.1 Non-mechanical Processes: Drying Beds	6
3.3.1.1 Sand Drying and Filtration Beds	7
3.3.1.2 Paved Drying Beds	9
3.3.1.3 Planted Drying Beds	12
3.3.2 Mechanical Dewatering Systems	14
3.4 Adjustment to the Moisture Content	15
3.5 Discussion	15
4 PROCESSES FOR LIQUID EFFLUENT TREATMENT	17
4.1 Waste Stabilization Ponds	17
4.2 Constructed Wetlands	19
4.3 Discussion	20
5 TREATMENT PROCESSES	20
5.1 Conventional Method: Composting	20
5.2 Pelletization of Dewatered Fecal Sludge or Composts	23
5.3 Possible Additional Processes	29
6 CONCLUSION	30
7 REFERENCES	32
8 APPENDIXES	35

LIST OF TABLES

Table 1. Characteristics of FS from septic tanks and public toilets in selected cities	2
Table 2. Key features, advantages and disadvantages of gravity thickening	4
Table 3. Comparison between selected/advanced thickening processes	5
Table 4. Key features, advantages and disadvantages of drying beds	6
Table 5. Key design features of a sand drying and filtration bed	7
Table 6. Characteristics of the paved drying beds in the Slamson technology	11
Table 7. Cost features of the Slamson Ghana technology for fecal sludge dewatering.....	11
Table 8. Key design features of a planted drying bed	13
Table 9. Comparison between selected/advanced dewatering processes.....	14
Table 10. Typical relative costs of selected thickening technologies for conventional wastewater treatment plant sludge thickening	16
Table 11. Main characteristics of the sludge dewatering process	16
Table 12. Comparison between typical sewage wastewater and LFS dewatering/thickening effluent	18
Table 13. Key features of selected treatment options for liquid effluents from dewatering units.....	19
Table 14. Typical characteristics of co-compost feedstock in Ghana.....	21
Table 15. Characteristics of compost heaps on day 1	22
Table 16. Types of pelletizers	23
Table 17. Key features, advantages and disadvantages of the IWMI pelletizing process	24
Table 18. Optimum moisture content and characteristics of produced pellets	26
Table 19. General requirements for co-compost pellet production.....	27
Table 20. Features, advantages and disadvantages of the Ladepa unit	28
Table 21. Additional characteristics of the Ladepa unit for different community sizes	28
Table 22. General requirements for Ladepa pellet production	28
Table 23. Key features, advantages and disadvantages of selected processes for FS recycling	29

LIST OF FIGURES

Figure 1. Conventional processes implemented for safe recovery of nutrients and organic matter in fecal sludge for agriculture	3
Figure 2. Schematics of three variants of settling tanks	4
Figure 3. Typical covered drying bed	6
Figure 4. Design characteristics of a sand filter	7
Figure 5. Manual sludge removal from a drying bed (Sludge drying beds at a sewage treatment plant, Bugolobi, Kampala, Uganda)	8
Figure 6. Case study: Tema, Ghana, September 2011	8
Figure 7. Paved drying bed	9
Figure 8. The pumping and polymer dosing unit	10
Figure 9. The on-site dewatering container (AVC)	10
Figure 10. The paved drying beds of Slamson Ghana Ltd., FS treatment plant	11
Figure 11. Planted drying bed	12
Figure 12. Energy requirement for selected dewatering/drying processes	17
Figure 13. Land requirement for dewatering/drying process implementation	17
Figure 14. Typical scheme of a waste stabilization system: An anaerobic, facultative and maturation pond in series	18
Figure 15. Overview and cost distribution of selected sewage plants	20
Figure 16. Heap composting of dewatered FS	21
Figure 17. Formation of three compost heaps (Accra, Ghana)	22
Figure 18. Monitoring of a typical heap (Accra, Ghana)	22
Figure 19. Temperature changes during co-composting of DFS:SD (1:3) heap	23
Figure 20. IWMI process for pelletization	24
Figure 21. a) The grinder, b) raw DFS, c) C-DFS not ground, and d) ground C-DFS	24
Figure 22. DFS compost enrichment-mixer (a) side, (b) top views, and (c) newly produced enriched DFS compost	25
Figure 23. Pellet production – a) pelletizer being operated, b) newly produced pellets, and c) final pellets (after drying and sieving)	25
Figure 24. Ladepa pilot plant; pellets from raw ‘solid’ FS in South Africa	27
Figure 25. Biochar produced from fecal sludge in Accra (Ghana)	30
Figure A8.1.1. Flow diagram of a rectangular flotation thickener	35
Figure A8.1.2. Rotary drum thickening system	35
Figure A8.1.3. Gravity belt thickening system	35
Figure A8.1.4. Filter belt press for sludge	36
Figure A8.1.5. The Bioburn plant	36
Figure A8.2.1. The Hosoya system applied in Greece and the United States	36

ACRONYMS AND ABBREVIATIONS

€	Euros
AVC	On-site dewatering container
BOD	Biochemical oxygen demand
C	Carbon
C-DFS	Compost of DFS
COD	Chemical oxygen demand
C-SDFS	Co-compost of DFS + sawdust
CSIR	Council for Scientific and Industrial Research
DFS	Dewatered fecal sludge
DOD	Diesel pumping and polymer dosing unit
EC-DFS	Enriched compost of DFS
EC-SDFS	Enriched co-compost of DFS + sawdust
EOD	Electrical pumping and polymer dosing units
FS	Fecal sludge
K	Potassium
FWSW	Free water surface wetland
LFS	Liquid fecal sludge
GI	Germination index
MIR	Medium wave infrared radiation
IWMI	International Water Management Institute
N	Nitrogen
NH ₄	Ammonium
NO ₃	Nitrate
O&M	Operation and maintenance
OMW	Organic market waste
P	Phosphorus
SD	Sawdust
SS	Suspended solids
SSFW	Subsurface flow wetland
TKN	Total Kjeldahl nitrogen
TN	Total nitrogen
TP	Total phosphorus
TS	Total solids, in percentage or in mg per L
US\$	United States Dollar
VFCW	Vertical-Flow Constructed Wetlands
WHO	World Health Organization
WSP	Waste stabilization ponds

SUMMARY

Fecal sludge (FS) contains important quantities of organic matter and nutrients that are valuable for agricultural production. Several approaches have been attempted over time for recovery of these assets. Presently, resource conservation and proper use of available materials are highly valued practices. This document describes technical solutions for the recycling of FS to benefit agriculture; this is particularly important for developing countries where there is an urgent need to enhance, at low cost, soil fertility for agricultural purposes.

First, the physical, chemical and biological properties of FS are described. In most cases, resource recovery from liquid FS starts with pretreatment which removes unwanted elements such as plastics and other foreign bodies. This is followed by dewatering which removes excess fluid. Key thickening and dewatering technologies are presented in detail, along with case studies. They are also compared with respect to the main selection criteria for technologies, such as costs or land requirements. As the liquid FS is dewatered, a liquid effluent is created which must also be processed via the technologies described. Dewatering allows for the

generation of a 'cake' or solid material that is suitable for further processing.

Composting of dewatered or dry FS is not mandatory. But it is often preferred to other sanitizing options because the final product is stabilized and fit for agriculture. In addition, composting can generate a marketable pathogen-free end product at a relatively low cost. In this context, the composting process is described in detail, covering variants of composting as well as key factors affecting compost quality. The procedures for quality control and monitoring are essential to guarantee continuous quality of the final end product.

To increase the compost's market value, work by the International Water Management Institute (IWMI) has shown that pelletization could be an appropriate approach. The benefits of pelletization, for example, include reducing compost bulk density, as well as storage and transportation costs. A case study of FS-based pellets produced with locally constructed machinery is provided. Other case studies on pellets produced from non-composted dewatered/dry FS are also given to highlight the key achievable features of different technologies.



Photo: Neil Palmer

1 INTRODUCTION

Each day, humans excrete in the order of 30 grams (g) of carbon, 90 g of organic matter, 10-12 g of nitrogen (N), 2 g of phosphorus (P) and 3 g of potassium (K). Most of the organic matter is contained in the feces, while most of the N (90%) and P (70-80%) is contained in urine. Potassium is equally distributed between urine and feces (Sobsey 2006). In developing countries, most of the population relies on on-site sanitation technologies. Currently, the management of fecal sludge (FS), the (semi-) liquid waste collected from onsite sanitation facilities is characterized by poor or unaffordable collection services and dysfunctional or inexistent treatment plants, resulting in indiscriminate disposal into the environment. Yet the increasing need for food products in the context of declining soil fertility, increasing levels of poverty, depletion of naturally occurring sources of nutrients such as rock phosphate and increase in the cost of fertilizer demand that sustainable solutions be sought to enhance agricultural productivity.

The organic matter and nutrients contained in excreta can be recovered and recycled as fertilizer-cum-soil conditioner – an effect not shared by chemical fertilizers – that is direly needed in tropical soils. Decomposed excreta improve soil structure by increasing water-holding capacity, reducing pests and diseases and neutralizing soil toxins and heavy metals (Cofie and Adamtey 2009). While farmers in some developing countries strive to apply animal manure and farm residues to improve soil fertility, in many cases such products are not readily available. This is not the case for human manure which is mostly readily available, especially in urban and peri-urban areas. However, its use is being constrained in some areas due to technical challenges for safe use, high transportation costs (due to volumes involved) and social challenges which include negative perceptions of using excreta in agriculture.

The objective of this document is to present an overview of stages and technical solutions available for safe recycling of FS and its by-products, mainly in agriculture, and to allow preliminary design by an implementer. Design of a process is a generic term which includes the identification of the appropriate process to be implemented in order to achieve a given goal as well as the sizing of the facility and definition of operating conditions. The identification of the right technology to be applied will depend on several factors such as the amounts of raw materials to be processed, the available financial resources (for construction, operation and maintenance), the level of complexity for the technology to be implemented and so forth. This paper describes and compares the different options to guide the preliminary design. Stages considered include the liquid FS drying processes, composting or co-composting and finally pelletization. Selected comprehensive solutions which have proven effective in some parts of the world are also presented. Experience acquired from several cases over

the world has also confirmed that adequate processing of FS-based materials could contribute to improving social acceptance of FS-based products.

When successfully implemented, the recycling of FS improves livelihoods by enhancing agricultural productivity, improving urban sanitation and creating employment for youth, women or marginalized people.

2 CHARACTERIZATION OF FECAL SLUDGE

Globally, it is estimated that over 2 billion people rely on on-site sanitation installations in urban areas, either at the household level or through shared facilities such as public toilets (Koné et al. 2010; Kvarnström et al. 2012). Such installations include latrines, aqua privies and septic tanks and constitute the main options for capturing human excreta. On a regular basis, they must be emptied either mechanically or manually – public toilets or at the household level – and ideally are treatable for disposal.

Fecal sludge is the waste extracted from the on-site facilities. It is a mixture of human excreta more or less diluted with flush water and toilet paper, and sometimes other waste types such as sponges, bones, wood, textiles, plant seeds, stones, plastics and sand (Niwagaba et al. 2014). As shown in Table 1, the characteristics of FS are highly variable from country to country and, within the same country, depending on the type and origin of the sanitation facility being used (Koné et al. 2010; Nartey 2013). If we consider just the physical properties of the liquid fecal sludge (LFS), two main types can be distinguished (Heinss et al. 1998):

- The low-strength (diluted) type usually comes from households' septic tanks. It is often stabilized (digested) due to its age (about one to three years on average) and therefore has a dark brown or black color. It contains from less than 10,000 mg [milligrams] per liter [l] up to 30,000 mg per liter total solids [TS]. In such liquid waste, the chemical oxygen demand (COD) levels are usually below 15,000 mg per liter.
- The high strength (concentrated) type is often obtained from public toilets, bucket latrines or any pour-flush or non-flush sanitation facility. This type of sludge contains more than 30,000 mg per liter of TS and has a COD level above 20,000 mg per liter. It has a yellowish/brown color and is less than a year old (typically as low as one week).

This classification is only indicative as factors such as rain, temperature or groundwater intrusion in the septic tank may influence the physical properties of the LFS. LFS accumulation in septic tanks varies also; for example it was on average 135-180 l per capita per year in Thailand (AIT 2012). The density of collected LFS depends on its origin (type of sanitation facility or country). It was typically 1,092-

1,159 kg [kilogram] per liter in Thailand (AIT 2012) and 1,000-2,200 kg per liter in Botswana [with the higher values being caused by the presence of sand and earth in LFS] (Radford and Sugden 2014). In Kampala, mean density was reported to be 1,001 kg per liter in 2014 and 1,423 kg per liter in 1985 (Radford and Sugden 2014).

FS is considered to be 'dry' (i.e. TS > 200,000 mg l⁻¹)¹ if originating from dry toilets or pit latrines (also called semisolid cake [Gonçalves et al. 2007]) and in such cases, recovery does not necessarily require a dewatering or drying step. Filling rates of pit latrines are lower than that of septic tanks, ranging on average between 25 and 75 l per capita per year (FSMS 2011). Compared to sewage wastewater, raw FS contains higher levels of pathogens (e.g. *Ascaris*, *Trichuris*) which could be responsible for deadly diseases if inadequately treated before being spread into the environment. In low-strength LFS, concentration of helminth eggs is typically about 4,000 eggs per liter of LFS while in the high strength LFS, values reaching 60,000 eggs per liter have already been reported (Heinss et al. 1998).

3 RECOVERY OF SOLIDS FROM LIQUID FECAL SLUDGE

3.1 Generalities

To recover solids from raw LFS, it is essential to remove the various non-organic wastes, such as plastic materials, prior to processing. This can be achieved by allowing the LFS to pass through a grid (manually or automatically cleaned) before reaching the receiving container or the processing unit (Kengne and Tilley 2014). Excess water in the LFS, which can be free, adsorbed, maintained by capillary forces or part of the cellular structure, can then be extracted through a variety of mechanisms. While free water can be removed by gravity, other cases require flocculation (to minimize adsorption) or a mechanical process (van Haandel and Lettinga 1994; von Sperling and Chernicharo 2005; Wakeman 2007). Depending on the level of water removal, the process is called thickening or dewatering. These processes have been studied extensively for sewage wastewater sludge treatment but less so for FS treatment.

TABLE 1. CHARACTERISTICS OF FS FROM SEPTIC TANKS AND PUBLIC TOILETS IN SELECTED CITIES.

PARAMETERS	SEKONDI/TAKORADI (GHANA)		ACCRA (GHANA)		YAOUNDÉ (CAMEROON)	BANGKOK (THAILAND) ¹	ALCORTA (ARGENTINA)	THAILAND
	Septic tank	Public toilet	Septic tank	Public toilet	Septic tank	Septic tank	Septic tank	Various
TS (mg l ⁻¹)	1,430-5,510 (3,245)	7,270 - 66,990 (37,200)	12,000	52,500	37,000	2,200-67,200 (15,350)	6,000-35,000	830-288,840 (17,426 ^a ; 10,500 ^b ; 189,975 ^c)
BOD ₅ (mg l ⁻¹)	700-1,300 (1,080)	3,500-9,800 (6,180)	840	7,600		600-5,500 (2,300)	750-2,600	3,290-33,090 (20,432 ^a ; 14,941 ^b ; 14,978 ^c)
COD (mg l ⁻¹)	1,400-9,200 (4,650)	8,300-56,200 (26,600)	7,800	49,000	31,000	1,200-76,000 (15,700)	4,200	
Total N (mg l ⁻¹)					1,100	300-5,000 (1,100)	190	
NH ₄ -N (mg l ⁻¹)	46-1,259 (472)	408-1,055 (577)	330	3,300	600	120-1,200 (415)	150	
NO ₃ -N (mg l ⁻¹)	9.2-40.2 (15.2)	2.3-49.5 (17.7)						
<i>Ascaris</i> (eggs number gTS ⁻¹)			13-94 ^d		2,813	0-14	0.1-16	
Total P (%)	1.2-4.5 (2.0)	0.3-1.9 (0.9)						
Total K (%)	1.9-15.4 (7.5)	1.0-11.9 (5.9)						
Electrical conductivity (µS cm ⁻¹)	1,000-6,000 (2,900)	8,100-54,000 (27,350)						
pH	8.0 ± 0.2	7.9 ± 0.4						

COD = chemical oxygen demand; BOD = biochemical oxygen demand. Value in brackets is an average.

^a: Non-commercial septic tank; ^b: Cesspool or cesspool system; ^c: Commercial septic tank. ^d: Data for Kumasi (Ghana). In addition, the concentration of *Trichuris* eggs was 2-24 eggs per gram of TS.

Sources: Cofie et al. (2006); Koné et al. (2007, 2010); AIT (2012); Nartey (2013).

¹ The water content remains high, but at such TS levels, the material has a texture that resembles paste or wet soil.

Thickening processes are primarily meant to reduce the volume of the sludge and/or to increase the dry matter content in order to facilitate the handling and processing of LFS in a dewatering system. Recent advances in solids' thickening and dewatering have increased performance and solids' capture rates while often reducing chemical and polymer consumption, electrical usage, space requirements and odor potential. In addition, automation can reduce the degree of operator attention required, thereby reducing, in some cases, the costs of operation (less staff required, optimal use of input per products).

and crops is also desirable (EPA 2000a). Treatment plants should be designed in a modular way for process security and potential extension.

To validate the selection of a technical option over others, it is essential to conduct a good analysis of the investment (land and equipment), operation (staff, electricity and other inputs) and maintenance (frequency of repairs, staff, spare parts) costs needed for normal operation while taking into account climatic conditions, input quality, output requirements and so forth.

Figure 1 presents the general process options and the steps to follow, depending on the desired end product, for processing of FS. Among general principles, the FS treatment plant should be designed to ensure that all incoming sludge can be processed during operating hours. To minimize odor generation (i.e. avoid higher organic sulfide emissions), it is important to reduce liquid storage time prior to processing to less than 24 hours. Selection of a polymer (if applicable)² that is non-toxic and has minimal impact on the environment

3.2 Thickening Systems

Thickening of the sludge may be required before dewatering of LFS. This process reduces sludge volume, usually by 50 to 90% by allowing the solids' concentration to increase to 5 to 10% in mass (Metcalf and Eddy Inc. 2003; Gonçalves et al. 2007; Kilian and Shimada 2009). When LFS is not stabilized, removal of water is difficult to achieve and addition of a polymer (for example chitosan; cellulose; starch; polyacrylamide; polyvinylpyridinium; polyacrylate;

FIGURE 1. CONVENTIONAL PROCESSES IMPLEMENTED FOR SAFE RECOVERY OF NUTRIENTS AND ORGANIC MATTER IN FECAL SLUDGE FOR AGRICULTURE.

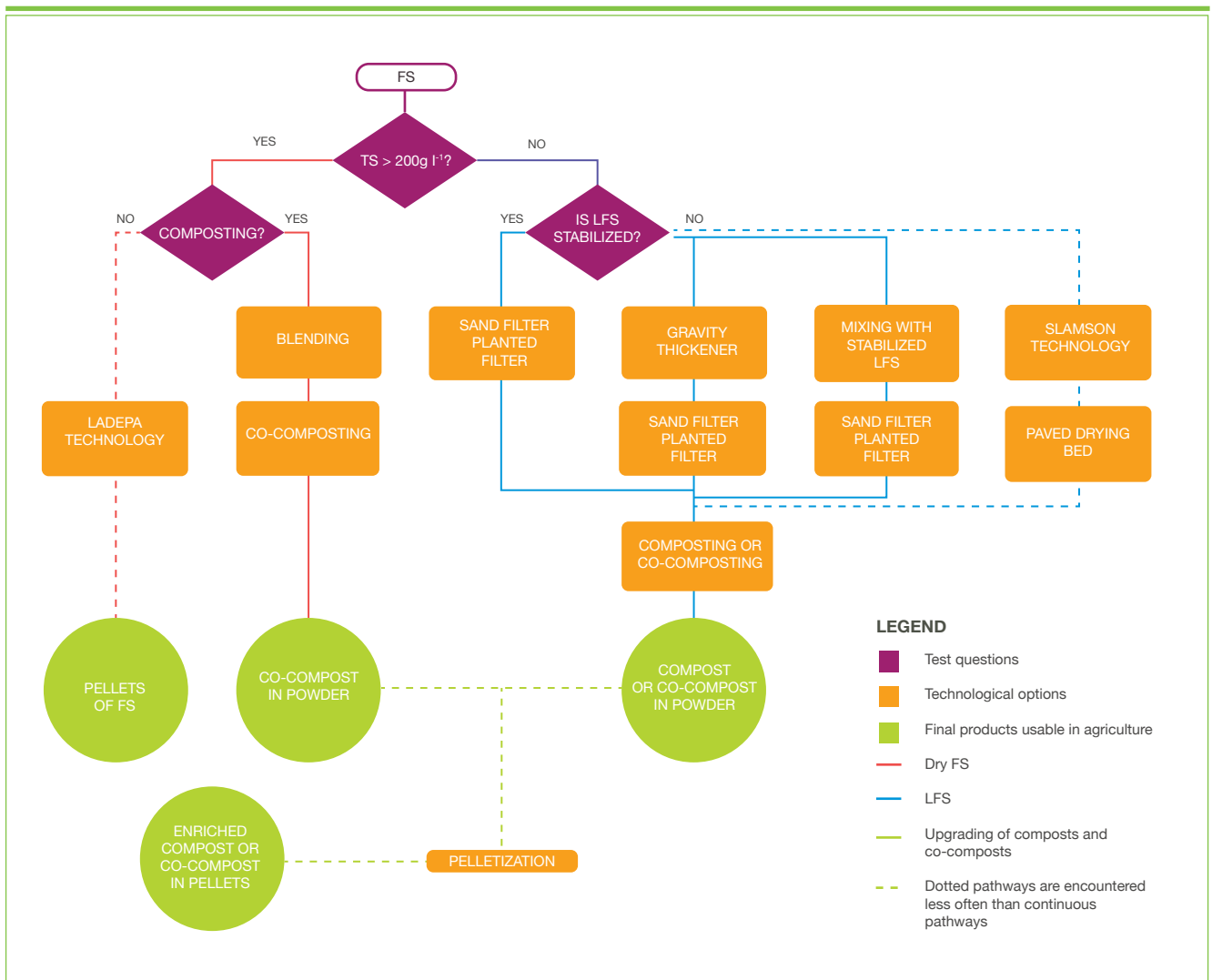

² The use of polymers increases the operation cost and is not advised. On the other hand, they may negatively influence reuse in agriculture, especially if non-biodegradable.

alum) may be required to facilitate the process. This induces flocculation in the FS, i.e. an aggregation of solids resulting in an increase in the size of the particles. This phenomenon facilitates the physical separation of the water and solid phases (von Sperling and Chernicharo 2005). Tests are recommended to verify that a given LFS can be thickened using any of the methods presented below and eventually the polymer dosage required.

3.2.1 Most Common Process: Gravity Thickener

A gravity thickener is a settling tank or a decanter in which solids are removed through gravity only. The system can also operate in batch mode (i.e. intermittently), to avoid the need for a sophisticated collection system for the thickened sludge. In such cases, at least two units are required and operate alternately. The settling unit can be of various shapes and sizes (depending on convenience) (Figure 2). In a typical case, the rectangular sedimentation tank had 3 meters (m) of depth while being 24 m long and 8.3 m wide (Heinss et al. 1998). But smaller tanks are also encountered (in Cambérène FS treatment facility in Dakar, Senegal,

each of the two tanks has 155 m³ of capacity) (Dodane and Bassan 2014). The design of the tank surface must facilitate the distribution of LFS flow. Consequently, a long and narrow basin should be favored (width to length ratio ranges from 0.1 to 0.3). The settling tank can also be a more sophisticated unit and consists of a circular tank (up to 25 m diameter and 3-4 m deep) with a conical bottom (slope between 1:6 and 1:3) equipped with collectors or scrapers to allow a continuous operation. Additional features, advantages and disadvantages of gravity thickening are presented in Table 2.

The overall BOD feeding rate is 1,000-1,500 g per m³ of tank per day (i.e. 3-5 times the normal feeding rate of a conventional anaerobic pond). The loading time of LFS into the settling unit depends on the size of the tank and is typically one to four weeks (Dodane and Bassan 2014). Then, it is given sufficient time to settle (from a few hours up to four weeks). The clarified water is then removed (to be treated subsequently) while the concentrated solid fraction becomes available for recycling.

FIGURE 2. SCHEMATICS OF THREE VARIANTS OF SETTLING TANKS.

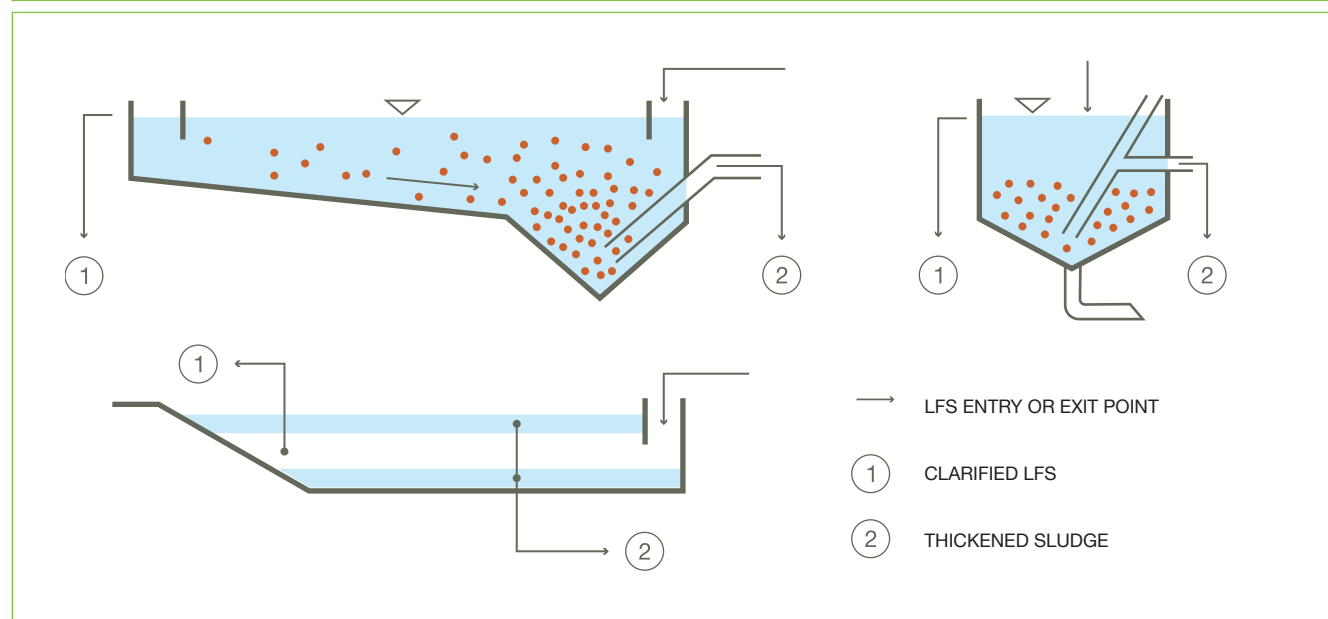

Source: EAWAG (2006).

TABLE 2. KEY FEATURES, ADVANTAGES AND DISADVANTAGES OF GRAVITY THICKENING.

KEY FEATURES	ADVANTAGES	DISADVANTAGES
<ul style="list-style-type: none"> ▪ TS in the settled sludge: 2-6% in mass for a residence time of 1-2 days and up to 15% for a residence time of 4 weeks ▪ TS in feeding LFS: variable ▪ Suspended solid (SS) recovery from the LFS: 60-80% ▪ COD removal: 30-50% ▪ TS loading rate: 1,200 kg m⁻² year⁻¹ ▪ Energy consumption: 0-20 kWh per metric ton of solids ▪ Land requirement: 0.006 m² per capita 	<ul style="list-style-type: none"> ▪ Simple to operate and maintain (does not require special skills) ▪ Lowest operating costs among thickeners ▪ Low power demand ▪ Low footprint (i.e. area of land required for implementation is low) compared to drying beds ▪ With long residence time, can process non-stabilized LFS 	<ul style="list-style-type: none"> ▪ Cyclic operation only (if low-cost) ▪ Can be odorous ▪ Most effective for diluted and stabilized/digested LFS ▪ Does not always remove floating particles, so the liquid fraction remains highly concentrated in SS, pathogens and organics ▪ Thickened sludge removal could require specialized/expensive equipment ▪ Thickened LFS must be dewatered further, e.g. using drying beds or a bulking agent must be added to it before (co-)composting

Sources: Heinss et al. (1998); Montangero and Strauss (2004); Dodane and Bassan (2014).

By allowing solids to sediment through gravity action, this process is one of the easiest and cheapest methods for thickening LFS. When the residence time is about less than one week, the thickened sludge (TS: 6-7%) from the bottom of the tank can be removed by pumps while powerful vacuum trucks could serve for the most compacted sludge and scum (Dodane and Bassan 2014). But it remains too wet to be recycled as such through, for example, composting. This explains why drying beds then have to be used to process it further to lower moisture levels. When the residence time in the settling tank/thickener is as high as four to eight weeks, it is possible to reach 18% of TS in the scum (resulting from natural flotation of light particles while sun-exposure contributes to its drying) and 15% of TS in the sediments (which corresponds to the maximum attainable in this type of system when sludge conditioning is not performed) (Heinss et al. 1998). For such residence time, a loss of 14% of organic matter (probably through natural decomposition) is also observed.

Conditioning of LFS, i.e. addition of a coagulant/flocculant (e.g. lime, alum, polymers at a dosage of between 1.5 and 5 g kg⁻¹ of dry solids) is being practiced in many developed countries but seldom in developing countries given the cost involved. The aim of this step is to improve the solids' capture from raw sludge and enhance the TS concentration at the bottom of the gravity thickener (Metcalf and Eddy Inc. 2003; EPA 2003; ACEE 2009; Kilian and Shimada 2009). However, addition of non-biodegradable or potentially toxic coagulant/flocculants may disqualify the dried FS from use in agriculture.

The operating and maintenance (O&M) cost of this type of system seems to be higher than that of sand drying beds or planted drying beds, but their investment costs are similar (Montangero and Strauss 2004).

3.2.2 Possible Additional Processes

Table 3 presents a comparison between flotation, rotary drum and gravity belt methods, i.e. three advanced thickening technologies.

Flotation is appropriate for separation of light solid particles that cannot easily settle but rather have the tendency to float. Gas (usually air) is artificially introduced into the separation system at pressures in excess of atmospheric pressure. The bubbles then attach themselves to the solid particles or become enmeshed in the solids matrix, forming gas-solid aggregates with density (ideally 0.6-0.7 kg l⁻¹) lower than that of the liquid. This causes the gas-solid aggregates to rise to the surface of the fluid and through skimming they can be collected. The major components of a flotation system include a pressurizing pump, an air injection unit, a pressure retention tank, a back pressure regulating device and a flotation unit (Appendix 8.1, Figure A8.1.1). The key operating components are air pressure, recycle ratio, solid input concentration, retention time, hydraulic loadings and ratio of air to solids. Polymers are sometimes used to enhance solid separation and create a thicker sludge blanket. Natural flotation, i.e. without addition of air, is observed in gravity thickeners (Heinss et al. 1998; Kilian and Shimada 2009).

The rotary drum has wedge wires, perforations and a porous media which could be of stainless steel and/or polyester

TABLE 3. COMPARISON BETWEEN SELECTED/ADVANCED THICKENING PROCESSES.

	KEY FEATURES	ADVANTAGES	DISADVANTAGES
Flotation	<ul style="list-style-type: none"> TS in the final product: 2-5% for a residence time of 1-2 days Solids recovery: 92% Hydraulic load: 0.8-5 m³ m⁻² day⁻¹ Typical diameter of the thickener: 17 m Energy consumption: 60-100 kWh per metric ton of solids 	<ul style="list-style-type: none"> Very efficient for conventional wastewater (non-LFS) biological sludge Requires similar area compared to gravity thickeners 	<ul style="list-style-type: none"> Can be odorous Higher operating cost than gravity thickeners Higher power requirement than gravity thickeners Works best when the sludge volume index (SVI) is < 50
Rotary-Drum	<ul style="list-style-type: none"> TS in the final product: usually 4-10% Water removal: 50-80% Feed capacity: < 86 m³ h⁻¹ Rotation speed of the drum: 5 to 20 rpm Energy consumption: 10-30 kWh per metric ton of solids 	<ul style="list-style-type: none"> Requires relatively less space Has relatively low capital cost Flexible operation possible (i.e. LFS & polymer feed rates and drum speed can be varied easily) Easy odor control because the unit is enclosed 	<ul style="list-style-type: none"> High concentrations of polymer required (2-10 g kg⁻¹ TS; typical: 4.5 g kg⁻¹ TS). This increases O&M cost Requires operator attention, unless automated
Gravity Belt	<ul style="list-style-type: none"> TS in the final product: 4-7% (up to 30% or more when coupled with a press) Solids recovery efficiency: 85-98% Belt width: 0.5-3.5m TS loading rate: 200-600 kg m⁻¹ h⁻¹ LFS loading rate: 90-680 kg m⁻¹ h⁻¹ Hydraulic load: 5-22 m³ m⁻¹ h⁻¹ Energy consumption: 10-60 kWh per metric ton of solids 	<ul style="list-style-type: none"> Easy start and shut-down Reduced noise nuisance (especially when compared to centrifuges) Low staffing requirements for O&M Automation of the operation is possible (10% increase of capital costs). Automation will reduce overall labor costs, polymer use and improve the efficiency of the process 	<ul style="list-style-type: none"> Polymers required at high concentrations (typical polymer dosage: 4.5 g kg⁻¹ TS) Poor control of odor More operator attention needed if feed in is not uniform in time The belt requires regular cleaning with water (typically at the end of each shift) Presence of oil, grease or foreign bodies (sharp objects) can blind or damage the belt Workers at the belt press area could be exposed to pathogens and hazardous gases

Sources: Metcalf and Eddy Inc. (2003); Turovskiy and Mathai (2006); Uggetti et al. (2010); IWK (2012).

fabric. To start the process, a polymer is often added to the feed LFS in a fixed drum. The mixture is later fed into the rotating-screen drum which separates the flocculated solids from the water by allowing free water to drain through the porous media while solids are retained on the media (Appendix 8.1, Figure A8.1.2). Solids are conveyed along the drum by a continuous internal screw or diverted angle flights and exits through a discharge chute. Rotary drums are often used as a thickening step in combination with a press for dewatering.

A gravity belt consists of a belt moving over rollers. The sludge is deposited on the belt, which allows dewatering by gravity drainage (sometimes with vacuum aid). Simultaneously, the concentrated sludge moves towards the discharge in the end (Appendix 8.1, Figure A8.1.3). In most systems, the belt unit is composed of 1) a polymer-conditioning zone; 2) a gravity drainage zone on the belt and 3) a squeezing zone (at low and high pressure). The gravity belt thickener is often coupled with a press system for further dewatering (Appendix 8.1, Figure A8.1.4; Section 3.3.2).

3.3 Dewatering Systems

Dewatering of LFS is a process which leads to an increase of the TS content in the LFS to at least 20%. At these moisture levels, the dewatered fecal sludge (DFS) has a texture ranging from thick paste (when the TS content is around 20%) to moist soil (when the TS content is 40%) and can easily be recycled. There are two main options applicable for dewatering/drying FS, i.e. non-mechanical and mechanical dewatering systems. The selection of the appropriate technology will depend on the type of FS to be processed as well as the required characteristics (such as moisture content) of the dewatered product.

3.3.1 Non-mechanical Processes: Drying Beds

When using non-mechanical systems, high dryness can be achieved in a one-step process, i.e. no thickening is required. These processes rely mostly on percolation to remove the free water and evaporation to remove the remaining water (adsorbed, maintained by capillary forces or part of the cellular structure). Such facilities are usually recommended

for small plants, i.e. expected to operate at community level (EPA 2000a; von Sperling and Chernicharo 2005).

Drying beds are the cheapest and most frequently used technology for LFS drying. Key factors known to influence their performance include precipitation (rain) and evaporation rates. They are advantageous for warm arid and semi-arid climates (Table 4). There are different types of drying beds for LFS. They include: sand drying beds, paved drying beds, planted drying beds and many variants, including wedge-wire drying beds or vacuum-assisted drying beds which are not discussed in this paper (Cofie et al. 2006; Wang et al. 2007; Kengne et al. 2009).

Drying beds can be odor sources. This is why they must be located at least 100 m from dwellings. They can also be covered with greenhouse-type enclosures to avoid rain effects (Figure 3). Cheapest covering options (such as plastic caps) could also be applied. Covered beds can require 25 to 33% less land than open units (Wang et al. 2007). Table 4 presents the key features, advantages and disadvantages of drying beds.

FIGURE 3. TYPICAL COVERED DRYING BED.



Source: Poppendieck (2008)

TABLE 4. KEY FEATURES, ADVANTAGES AND DISADVANTAGES OF DRYING BEDS.

GENERAL KEY FEATURES	ADVANTAGES	DISADVANTAGES
<ul style="list-style-type: none"> ▪ Normal residence time: 7-42 days ▪ TS in the final product: 20-45% ▪ SS recovery: 70-95% ▪ No energy consumption in most cases ▪ Operation in batch mode (i.e. per cycle) 	<ul style="list-style-type: none"> ▪ Low/no energy consumed ▪ Low capital cost where land is readily available ▪ Little attention and skill needed for O&M ▪ Low/no chemical consumption ▪ Tolerate some level of sludge composition variability ▪ The final product is usually dryer compared to mechanical methods 	<ul style="list-style-type: none"> ▪ Cyclic operation only ▪ Not well suited for drying non-stabilized/digested sludge alone ▪ Requires larger land area than mechanized methods ▪ Drying level/time depend on climatic condition and therefore could lack consistency ▪ Sludge removal is labor-intensive, especially for sand beds ▪ Can be smelly or unsightly ▪ Nitrogen loss to the air and organic matter loss through decomposition may occur

Sources: Montangero and Strauss (2004); Koné and Strauss (2004); Cofie et al. (2006); Wang et al. (2007); Kuffour et al. (2009); SSWM (2013d).

3.3.1.1 Sand Drying and Filtration Beds

Sand drying beds are the oldest and most common drying bed type (Figure 4). They include filters using sand/gravel as media on which batch loads of sludge are dewatered. Two physical mechanisms are involved in the drying process: filtration (especially over the first one to three days) concerns 50 to 85% of the water removed and evaporation (the remaining days) for the balance. The total duration of the drying cycle depends on the climate and LFS type which affects its level of natural stabilization (Section 2). Table 5 presents key design features for a sand drying and filtration bed.

Digested/stabilized sludge, which is not readily amenable to mechanical dewatering, is best dried through this technology. However, fresh (nearly undigested) sludge has difficulty being dewatered on drying beds given that most of its water content is not free, i.e. drainable (as it is for stabilized sludge). So, direct drying of public toilet septage alone should be avoided since drying performance is often low and unpredictable (Heinss et al. 1998; Cofie et al. 2006). But introducing anaerobic digestion of LFS as a pretreatment to facilitate drying with sand filters would not

necessarily simplify the process, i.e. reduce operating costs for the drying, reduce the duration of the drying bed cycle or facilitate the implementation of the reuse process. Unless the end-goal is to produce and use the biogas, introducing anaerobic digestion could result in a more technologically complex process, more expensive than 'direct' drying. Indeed, proper management of biodigesters is a complex science which could require significant training and follow up. On the other hand, anaerobic digestion for biogas production could cause a delay of up to three to five years before the sludge would be available for co-composting. This is because most of the carbon contained in the LFS would be converted into methane and carbon dioxide, leaving mainly nutrients in the slurry flowing out of the digester. For subsequent co-composting, large amounts of carbon-rich waste would have to be added. This should also result in lower amounts of co-compost being generated while biogas is being produced. Also, if digestion is not thermophilic, the need for a thermophilic process, such as co-composting, to render the reused product safe in a reduced period of time would still remain. Otherwise, sanitization would require extended storage of six months up to more than one year before it could be safely applied as a fertilizer (Cofie et al.

FIGURE 4. DESIGN CHARACTERISTICS OF A SAND FILTER.

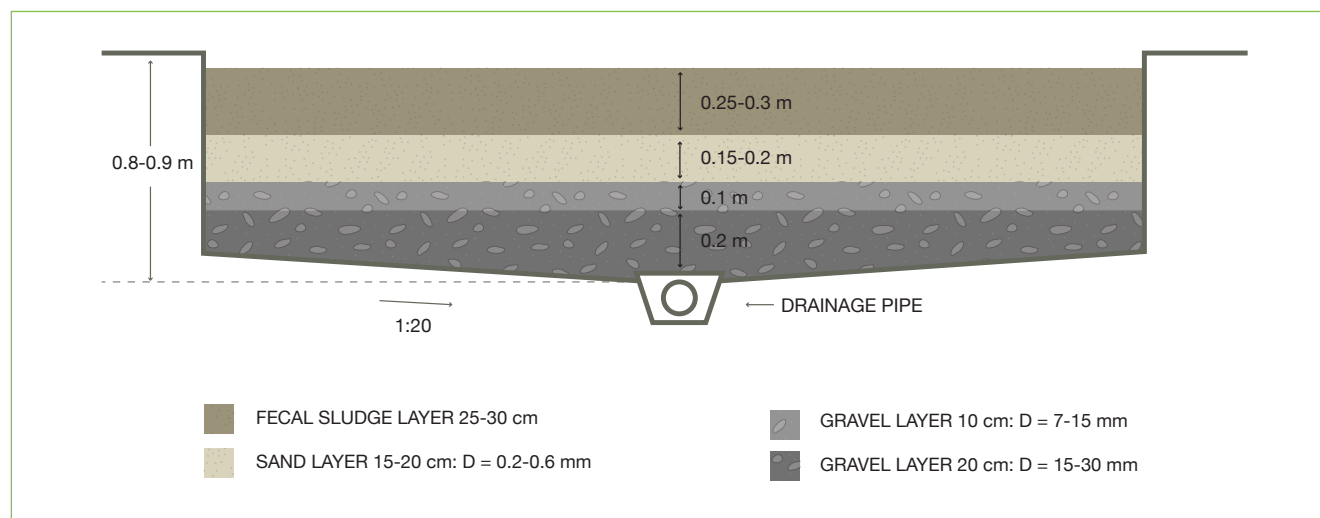

Source: Cofie et al. 2006

TABLE 5. KEY DESIGN FEATURES OF A SAND DRYING AND FILTRATION BED.

<ul style="list-style-type: none"> ▪ TS in feeding LFS: up to 4.5% ▪ LFS feed layer height: 20-30 cm upon feeding ▪ Loading rate: 100-475 kg TS m⁻² year⁻¹ (longer drying time is required when load is high) ▪ Width of the bed: 4.5-18 m ▪ Length: 6-45 m (excluding the LFS dumping point, if any) ▪ Drying time: 7-35 days to reach 20% TS, which is the minimum level for spadability ▪ General land requirements: > 0.05 m² per capita for a 10-day drying cycle ▪ SS removal: 60-95% ▪ COD removal: 70-90% ▪ NH₄⁺-N removal: 40-60% 	
<p>Sand characteristics</p> <ul style="list-style-type: none"> ▪ Height of layer: 10-30 cm (typical: 15 cm) ▪ Effective size: 0.2-1.2 mm (typical: 0.1-0.6 mm) ▪ The sand layer is replaced once every 4 cycles. 	<p>Gravel characteristics</p> <ul style="list-style-type: none"> ▪ Height of layer: 10-45 cm (typical: 25 cm) ▪ Effective size: graded from 7-30 mm (typical: 10 & 19 mm)

Sources: Strauss et al. (1997); Heinss et al. (1998); Metcalf and Eddy Inc. (2003); Koné and Strauss (2004); Montangero and Strauss (2004); Cofie et al. (2006); Kuffour et al. (2009); Kuffour et al. (2013).

2014). The best way to dewater public toilet septage remains therefore to mix it with household septage and dewater it using drying beds.

Experiments conducted in Ghana showed that over an eight-day period, levels of TS in the dried sludge were 70, 40 and up to 29% for mixtures of household septage and public toilet septage raw LFS (volume ratio: 4:1), sludge thickened in a pond (gravity thickening) and public toilet septage LFS, respectively (Heinss et al. 1998). Earlier work established that a mixture of household septage and public toilet septage (volume ratio of 2:1) was appropriate for dewatering, requiring seven to 21 days per cycle, depending on climatic conditions (Cofie et al. 2006; Kuffour et al. 2009; Kuffour et al. 2013). Additional details are given in the following case study description.

Removal of sludge from sand drying beds is usually performed manually (Figure 5), when the TS content reaches 20-30% (i.e. it no longer sticks to the sand layer), which makes operational labor significant. This is because small tractors or loaders cannot be operated on loose sand or are not supported by the sand structure. For manual removal of the sludge, the labor requirement is in general 0.5 to 4.3 hr

m⁻² year⁻¹ (i.e. 1-9 hours per metric ton of TS) (Metcalf and Eddy Inc. 2003; SSWM 2013a; IWMI 2013; Dodane and Ronteltap 2014). If mechanization of this step is mandatory, specialized equipment for cake scraping must be used and the cake should have 20 to 30% TS content.

FIGURE 5. MANUAL SLUDGE REMOVAL FROM A DRYING BED (SLUDGE DRYING BEDS AT A SEWAGE TREATMENT PLANT, BUGOLOBI, KAMPALA, UGANDA).



Source: "Reproduced from DMTC (2011) with permission from DMTC". Photo taken by R. Kyeyune.

Case Study: Dewatering of Fecal Sludge Using Sand Drying Beds in Greater Accra at a Pilot Scale

Raw LFS was experimentally dewatered on sand drying beds located at the LFS treatment site of Nungua Farms (Accra, Ghana). The LFS treatment facility has four drying beds, of which two served in the present trial. The dimension of each drying bed was 18.3 x 12.2 m (i.e. 223 m²). A mixture of sludge from public toilets septage (three truckloads, each having a capacity of 10 to 12 m³) and households' septage (six truckloads) was loaded onto each drying bed at an approximate volume ratio of 1:2 (Figure 6).

For public latrines, the retention time at source was two to four weeks (average: 2.4 weeks) and the TS content was 30-50 g l⁻¹. For household LFS, the retention time at source was one to three years (average: 1.6 years) and the TS content was 5-10 g l⁻¹. The duration of the drying cycle was seven to 21 days (average of 10 days), depending on climatic conditions.

FIGURE 6. CASE STUDY: TEMA, GHANA, SEPTEMBER 2011.



a. A cesspit emptier desludging onto a drying bed.³



b. Fresh FS on the drying bed (on day 1).

³ Under an ideal situation, the LFS should have been filtered to allow removal of plastics and other non-organic wastes. It would have also been poured onto the sand bed through a distribution system. This was not done because the available unit did not allow that.



c. Almost dried FS (after one week).



d. DFS collected into sacks (after two weeks).

Source: IWMI (2011).

The removal of DFS from drying beds required two to four hours of labor per metric ton. The DFS produced typically contained 27 g kg^{-1} of N, 12 g kg^{-1} of P and 6 g kg^{-1} of K that could be recycled. The amount of DFS obtained was 10 to 25 kg m^{-3} of LFS mixture or 4 to 12 kg DFS m^{-2} of the drying bed per drying cycle (Nikiema et al. 2013). This difference was in part due to the variability of TS composition of the raw LFS being dried as well as the size and filling level of the LFS truckloads. An extrapolation allows conclusion that the TS collection rate achieved in this case is potentially $200 \text{ kg DFS m}^{-2} \text{ year}^{-1}$. Earlier research under similar operating conditions has demonstrated that use of drying beds allows reduced concentrations of helminth eggs in DFS, typically by 35-60% for a drying time of seven to 10 days (moisture content of 80% in DFS) (Koné et al. 2007). The characteristics of the percolate from the drying beds were as follows: TS = $5,100\text{-}5,700 \text{ mg l}^{-1}$ (80% removal); SS = $290\text{-}600 \text{ mg l}^{-1}$ (97% removal); COD = $3,600\text{-}5,600 \text{ mg l}^{-1}$ (87% removal); BOD = $870\text{-}1,350 \text{ mg l}^{-1}$ (88% removal); helminth eggs: 0 eggs per liter (100% removal) (Cofie et al. 2006).

3.3.1.2 Paved Drying Beds

The main advantages of paved drying beds (Figure 7) are that they require less bed maintenance than sand filters. Indeed, capital costs, O&M of sand drying beds could typically be three and four times that of paved beds, respectively (Wang et al. 2007). Also, an automated device or a mechanical

tool can easily be used to occasionally mix the sludge being dried or remove it from the paved bed. But they also require more area than sand beds, which has contributed to limiting their use globally. In an arid climate, paved beds could be preferred to sand drying beds given the potentially high evaporation rate.

FIGURE 7. PAVED DRYING BED.

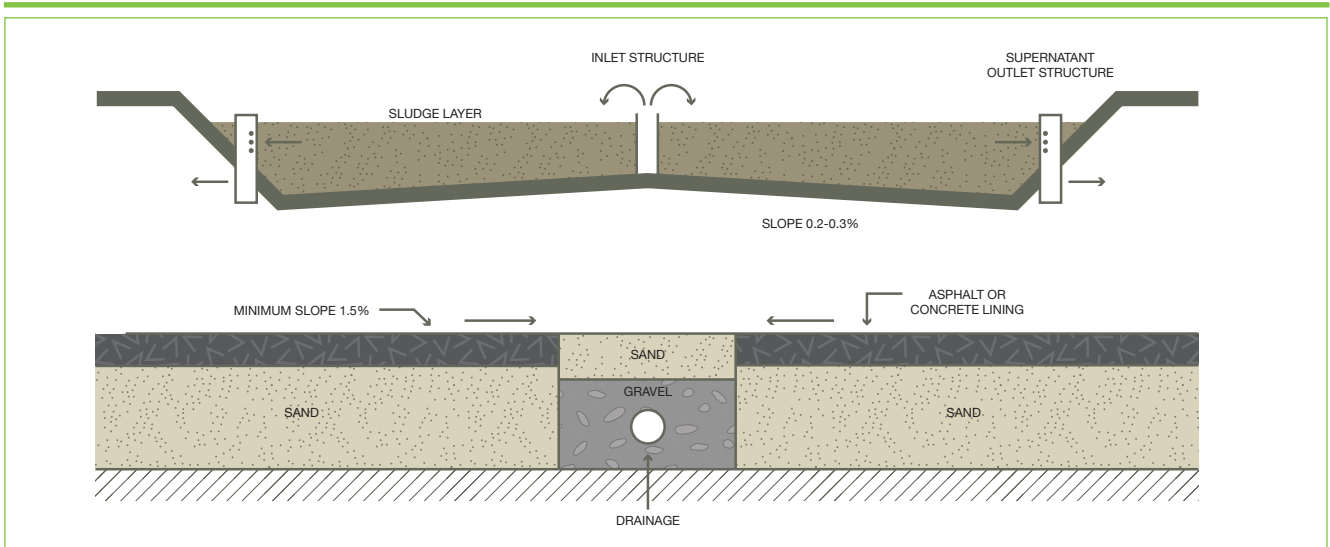

Sources: a. Reproduced from von Sperling and Chernicharo, C.A.D.L. (2005), with permission from the copyright holders, IWA Publishing; b. Wang et al. (2007).

Case Study: Dewatering of LFS Using Gravity Thickening and Paved Drying Beds

Slamson Ghana Ltd. operates a plant which involves the use of the 'Simon Moos AVC & DOD/EOD' system (Danish technology) to thicken 600 m³ of LFS per day generated in Accra (Ghana) reducing volumes by up to 90%.

The Accra thickening system is composed of two main components, the first being the pumping and polymer dosing unit (Figure 8). During this step, the LFS discharged by trucks in a reservoir equipped with a grid for plastic and other coarse material removal, is pumped out (Design TS = 66 g l⁻¹) and mixed with a polymer. This, i.e. ZETAG[®] 7861, is a cationic polyacrylamide dispersed in light mineral oil. The addition of the polymer causes flocculation of the particles (i.e. increase in their mass and volume) in the LFS that increases the speed and efficiency of the water extraction process. The selection of the polymer is mainly influenced by its cost. Typically, 5-6 l of polymer solution for 1,000 l of LFS are needed during the process. Fewer amounts could be used if residence time in the subsequent phase is increased. The actual amount of polymer injected can be regulated by adjusting the speed of the polymer pump. However the pump could be damaged when crude debris such as stones, heavy sand and metal is present in the LFS. If that is the case, a cyclone system for the addition of the polymer could be used in lieu of the pump. The energy required for the operation of the pump can be supplied through a diesel engine (as in the Accra case) or electricity.

FIGURE 8. THE PUMPING AND POLYMER DOSING UNIT.

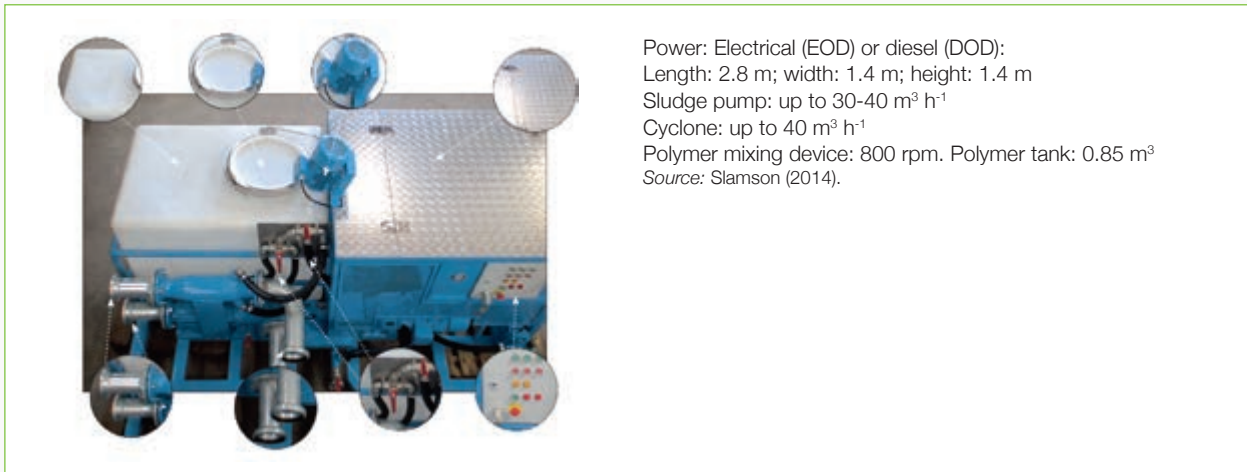

Next, the flocculated LFS is sent through a filler pipe into the bottom of the on-site dewatering container (AVC) (Figure 9). This AVC is a gravity-thickening system, constructed as a container, and equipped on the inside with filtration screens along the two sides and down the center. The filtration screens drain the free water and therefore thicken the flocculated sludge. The reject water is discharged through valves on the front of the AVC. The sludge volume reduction achieved in the AVC is 80% to 95% (90% on average), depending on the initial TS content of the sludge. The rear of the AVC container is equipped with a full-width door, through which the dewatered sludge is emptied. Each container can process 100 m³ per day of conditioned LFS, so all six containers are used daily under a full operation scenario (600 m³ per day of LFS). A machine for lifting each container is required to empty its content on paved drying beds each day (Table 6). The AVC and the dosing unit are mobile and simple to operate.

FIGURE 9. THE ON-SITE DEWATERING CONTAINER (AVC).

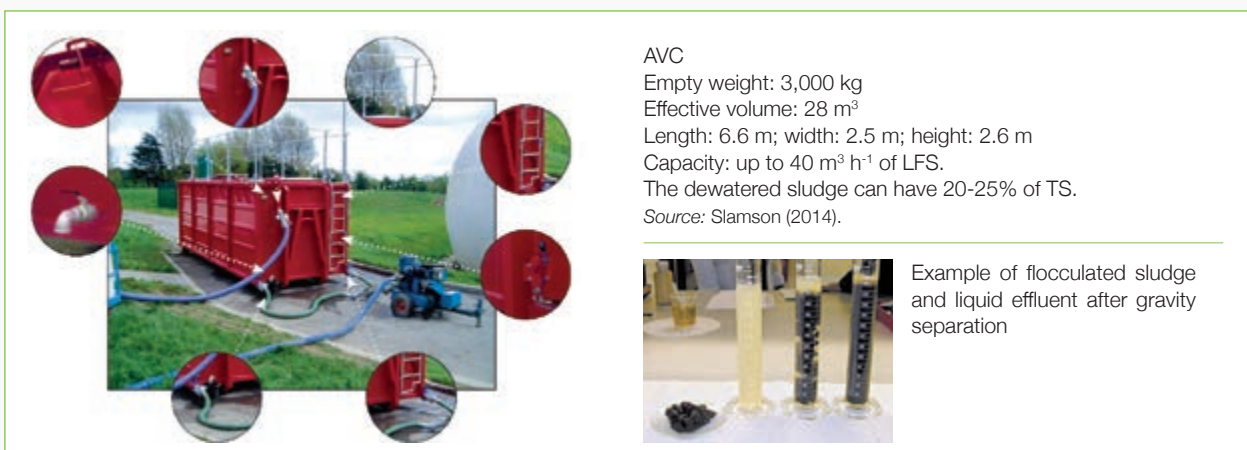

TABLE 6. CHARACTERISTICS OF THE PAVED DRYING BEDS IN THE SLAMSON TECHNOLOGY.

TYPE OF DRYING BED	DRAINAGE ¹
Number of drying beds	5
Length	30 m
Width	8 m
Construction material	Reinforced concrete
Slope	1.67%
Feeding rate per drying bed	Up to 60 m ³ of dewatered sludge
Average residence time on drying beds	4-5 days

¹In practice, drainage is limited, and most of the water is removed through evaporation.

Source: Slamson (2014).

A residence time of four to five days is used for drying with paved drying beds (Figure 10). The dewatered fecal sludge (DFS) produced which typically contains 41 g kg⁻¹ of N, 28 g kg⁻¹ of P and 6 g kg⁻¹ of K can be recycled. Through this process, it is claimed that 80, 95 as well as 85% reduction of BOD (design inlet: 8,630 mg l⁻¹), COD and TS in the liquid is achieved (depending on the polymer dosage), respectively. In the future, it is planned to use a horizontal subsurface flow constructed wetland to polish the process liquid effluent (Section 4.2). The total N (design TKN level is 4,633 mg l⁻¹) and P recovered in the solid phase are 60 and 70%, respectively.

FIGURE 10. THE PAVED DRYING BEDS OF SLAMSON GHANA LTD., FS TREATMENT PLANT.



Source: IWMI (2014).

The capital expenditure for setting up such a plant (600 m³ per day) is approximately US\$ 1 million and it will have a life time of at least 10 years if properly maintained. Operational costs are approximately US\$ 250,000 annually (for six days of operation per week). Currently, energy consumption is less than 10 l of diesel per day. In the long term, solar energy is being considered. Table 7 presents the costs for a similar plant with various capacities. There is also an option to purchase second-hand equipment at 50% of the normal cost in Table 7.

TABLE 7. COST FEATURES OF THE SLAMSON GHANA TECHNOLOGY FOR FECAL SLUDGE DEWATERING.

CAPACITY	OPERATING COST (US\$)	CAPITAL EXPENDITURE (US\$)
300 m ³ day ⁻¹ or 93,900 m ³ year ⁻¹	150,000 ^a	600,000-700,000 ^a
600 m ³ day ⁻¹ or 187,800 m ³ year ⁻¹	250,000 ^a	1,000,000 ^a
1,400 m ³ day ⁻¹ or 438,000 m ³ year ⁻¹	700,000 ^a 730,000 ^b	3,990,000 ^a 4,340,000 ^b

^aExcluding or ^bincluding the treatment plant for the residual liquid.

Source: Slamson (2014).

3.3.1.3 Planted Drying Beds

The planted drying bed (or vertical-flow constructed wetlands [VFCW]) is known as a low cost and effective technology for LFS dewatering (Figure 11). The process involves selected emergent plants which are responsible for the dewatering of sludge by allowing high evapotranspiration (depending on climatic conditions) through the vegetation while the root system facilitates the drainage and biofiltration of water (SSWM 2013d). The plants also stabilize the sand surface to avoid the formation of erosion channels (Kengne et al. 2012). Criteria for plant selection include capacity to grow a deep rhizome and root system, good multiplication in the presence of LFS, toleration of different water levels, variable pH or high salinity and resistance to insects/pest attacks (Kengne et al. 2012). Examples of plants are *Echinochloa pyramidalis*, reed (*Phragmites australis*) and cattail (*Thypha latifolia*). The initial density of plants is 4-12 rhizomes m^{-2} . Following each application of the raw LFS to the surface of the drying bed, its dewatering occurs subsequently for one to seven days before new feed is added. The duration of the resting time depends on operating conditions, such as TS content of the LFS. Removal of solids accumulated is not required before applying a new feed. So, with time, the dry matter accumulating on the surface is being stabilized and mineralized (Kengne and Tilley 2014).

In such treatment systems, removal efficiency of NH_4^+-N is typically 78% while that of TN, COD or SS is higher than 90% (Kengne et al. 2009; Kengne et al. 2012). Based on the same study, the loading rate must be maintained around 100-250 kg TS $m^{-2} year^{-1}$ to avoid clogging. Parasites and

helminth eggs are trapped at the surface of the filtering matrix but drained liquid often requires further treatment before it can be released safely or recycled to irrigate crops. However, the amount and quality (typically, COD: 250-500 $mg l^{-1}$; TS: 1,500-4,000 $mg l^{-1}$; SS: 100-300 $mg l^{-1}$) of liquid are lower and better than that from a conventional sand filter, respectively (Montangero and Strauss 2004; Koné and Strauss 2004).

Table 8 presents the key design features of planted drying beds. Planted drying beds are as vulnerable as sand drying beds to sludge accumulation (Cofie et al. 2006; Kengne et al. 2009). Clogging is the most critical and encountered operational problem in planted drying beds, and its occurrence rate must be minimized (Uggetti et al. 2010). The harvesting rate of the plants depends on their type and LFS loading rate. Typically, it must be once every year, but could also be conducted owing to other factors such as the need to sell the plants at a given time or the need to mitigate insect attacks. Replanting plants is not required when the harvesting is done properly. Removal of sludge however should occur once every three to five years (Heinss et al. 1998; SSWM 2013d). It is to be noted that sludge removal and regrowth is laborious and results in a periodic interruption of the operation. The dry matter generated from the system contains less than 70% of water and typically contains 2% N, 22.6% C and 1% of P. About 100-150 dry metric tons of plant biomass per hectare could be generated with such systems.

FIGURE 11. PLANTED DRYING BED.

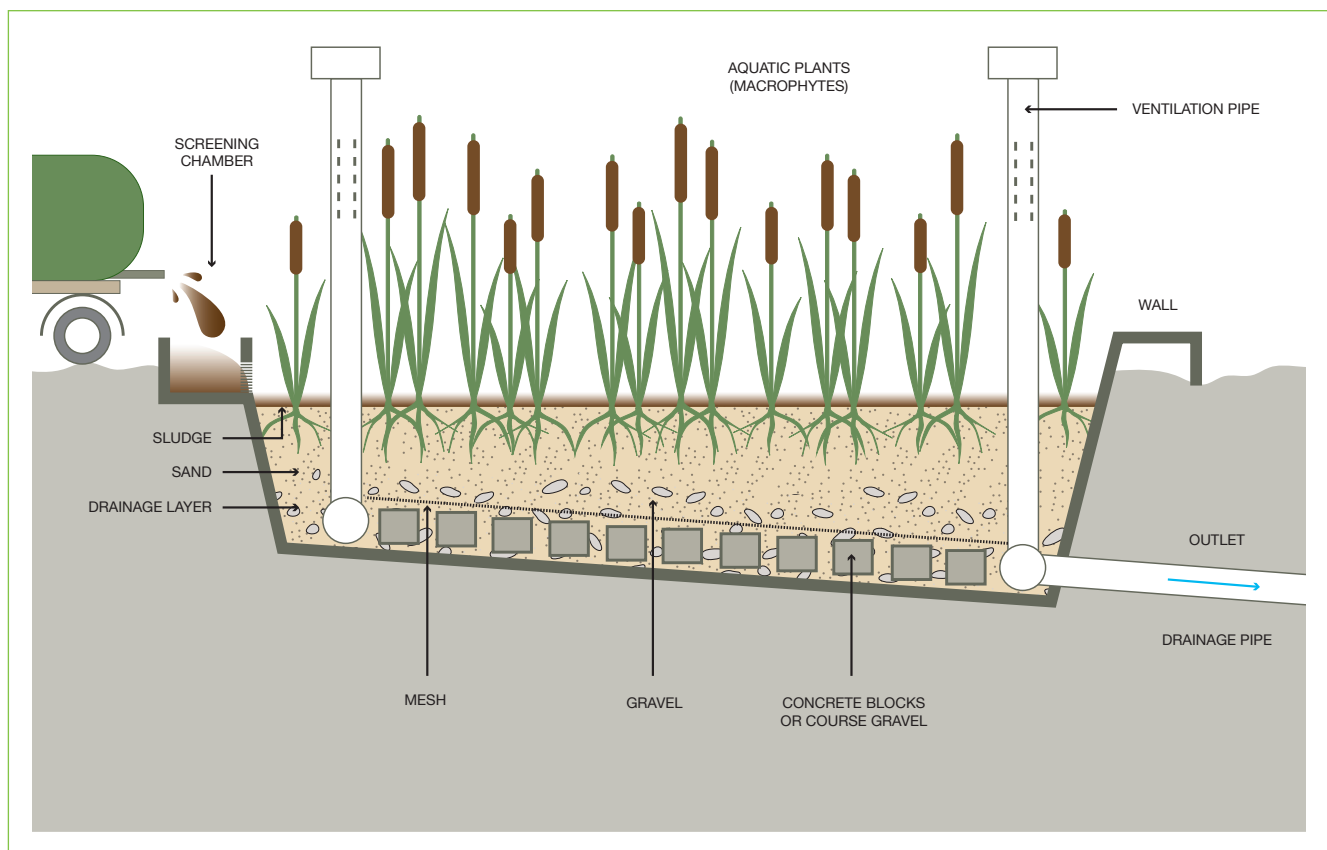

Source: Morel and Diener (2006).

TABLE 8. KEY DESIGN FEATURES OF A PLANTED DRYING BED.

Key features		
<ul style="list-style-type: none"> ▪ TS in feeding LFS: 3% ▪ Drying cycle duration: typically 1-7 days ▪ Sludge height: 10 cm per cycle ▪ Total bed depth ▪ Filter medium: 0.3-0.7 m ▪ Maximum sludge layer: 1.5-1.6 m (or the operation is stopped when the sludge layer is 20 cm below the walls of the bed) ▪ Loading rate: 100-250 kg TS m⁻² year⁻¹ (typically 100 kg TS m⁻² year⁻¹) ▪ Land requirement: Typically 0.025 m² per capita ▪ Width of the bed: 4.5-18 m ▪ Length: 6-45 m 		
Sand characteristics	Gravel characteristics	Stone characteristics
<ul style="list-style-type: none"> ▪ Height of layer: 10-15 cm ▪ Effective size: 0.5-1.0 mm 	<ul style="list-style-type: none"> ▪ Height of layer: 20-30 cm ▪ Effective size: 2-10 mm 	<ul style="list-style-type: none"> ▪ Height of layer: 15-25 cm ▪ Effective size: 20-50 mm

Sources: Montangero and Strauss (2004); Kengne et al. (2009, 2012); SSWM (2013d).

The harvested by-products of this technology, i.e. plants and biosolids, can be recycled in agriculture as soil amendments or animal feed, respectively (Montangero and Strauss 2004; Kengne et al. 2009; Kengne et al. 2012; SSWM 2013d). However, pathogen levels could remain high in the sludge (e.g. 79 eggs per g TS), therefore requiring extended storage (at least six months, either directly on the bed or after the sludge was extracted) or composting before farm use. In the wetland, 25-30% of organic matter is lost. Planted beds

can accept high concentrations of TS in the LFS (typically 2.5-124.4 g l⁻¹ of TS in the LFS). Planted drying beds were reported to favor breeding of mosquitoes in some instances, more than sand drying beds (Dodane et al. 2011).

The investment costs of planted drying beds versus sand drying beds are typically similar, but operation/maintenance cost is slightly lower for planted drying beds (Montangero and Strauss 2004).

Case Study: Dewatering of Liquid Fecal Sludge Using Planted Drying Beds at the Cambérène Treatment Facility (Dakar, Senegal)

Test planted drying beds could have been in operation since 2008 at the Cambérène treatment facility in Dakar, Senegal. The 130 m² plant is a scaling up from a pilot unit of 4 m² of surface area. *Echinochloa pyramidalis* was preferred to *Typha australis* and *Phragmites vulgaris* as growing plants. At the time of planting (depth of 5 cm), the stems were 20 cm high and the root had at least two nodes. The bed was humidified with a low-strength fecal sludge (i.e. decanted LFS) before and after planting was achieved. Then, the LFS feeding rate was gradually increased from 50 to 200 kg TS m⁻² year⁻¹ (i.e. normal operation feeding rate) over a period of three to four months (e.g. +25 kg TS m⁻² year⁻¹ after two weeks). During this transition period, frequency of sludge feeding was at least twice a week. The sludge accumulation was 0.1 m at the end of this period. The density of plants which was initially 9-12 plants m⁻² increased to about 1,000 stems m⁻² (height being 3 m on average) during the same period (Dodane et al. 2011). Removal of coarse and other foreign bodies from LFS prior to introduction onto the bed is essential (Kengne and Tilley 2014).

This initial stage requires proper monitoring and frequent moisturizing (or ponding) because the sand filter normally dries quickly given the lack of sufficiently accumulated sludge, which could result in plant mortality. Salt accumulation as a result of evaporation must also be controlled through frequent flushing. As much as possible, start-up should occur during the rainy season to facilitate the process. As much as possible, sludge distribution must be uniform to avoid wilting in areas that receive insufficient or excess sludge (Dodane et al. 2011). This can be achieved by allowing the drying bed to be equipped with 2 feeding points. Once the start-up phase is complete, the planted drying bed can be operated successfully for years.

From this preliminary experience in Dakar, it appeared that during normal operation, a daily feeding was necessary to minimize impact on plants of high evaporation rates. The performance of the plant in Senegal was 97, 99 and 91% for total solids, suspended solids, COD and ammonium (Barro 2012).

3.3.2 Mechanical Dewatering Systems

They imply water-removing mechanisms such as filtration (vacuum filters), squeezing/compaction (press), capillary action or centrifugation. The sludge feeding the mechanical dewatering system is often thickened, even though this is not absolutely required. As a general rule, sludge that is less compressible, less gelatinous and lower in organic content (established through measuring of volatile solid content) is generally easier to dewater with mechanical processes (SSWM 2013a). This explains why digested sludge is not readily amenable to mechanical dewatering. This also explains the need for preconditioning of the digested sludge through, for example, addition of polymers (to induce flocculation of the sludge) (von Sperling and Chernicharo 2005). During the dewatering process, high shear dewatering and conveying devices can increase odor release. Mechanical dewatering is usually cost effective only for large plants, i.e. it is not meant for community-level operation (SSWM 2013a). Table 9 presents comparisons between belt filter, centrifuge and thermal drying, three advanced dewatering processes.

Belt filter presses have at least one moving belt for dewatering using a combination of gravity drainage and compression (Table 9). Solids are dewatered following three operational stages: chemical conditioning, gravity drainage and compaction in a pressure and shear zone (Appendix

8.1, Figure A8.1.4). Therefore, the performance of belt filter presses is influenced by the physical properties of the material to be dewatered, type of chemical conditioning and the belt pressure. The operation of the belt filter press begins when the polymer-flocculated solids enter the gravity drainage zone. Filtrate from the gravity zone is collected and piped into a drain system. The thickened solids leave the gravity zone and enter the compression zone. Dewatering occurs as the solids are squeezed between two porous belts. The pressure increase begins in the wedge zone where the two belts are brought back together, following the gravity zone. Pressures continue to increase as the solids pass through the wedge zone and enter the high pressure or drum pressure stage of the belt filter press. The belts travel around several drums or rollers of varying diameters to maximize shearing action. The shear forces in the high pressure section are designed to be great enough to release some of the bound water and possibly some intercellular water.

There are also additional types of presses which could be used for LFS dewatering such as the **recessed-plate filter press**. This type of process is among the oldest of dewatering devices. Among mechanical dewatering equipment, it produces the highest cake solids' concentration (TS: 20-40%). Unless the inorganic content of the feed solids is high, preconditioning (addition

TABLE 9. COMPARISON BETWEEN SELECTED/ADVANCED DEWATERING PROCESSES.

	KEY FEATURES	ADVANTAGES	DISADVANTAGES
Belt filter presses	<ul style="list-style-type: none"> TS in the final product: Up to 30% Solid capture rate: 80-90% Hydraulic loading rate: 10-15 m³ h⁻¹ m⁻¹ Solid loading rate: 218-272 kg TS h⁻¹ m⁻¹ Energy consumption: 10-60 kWh per metric ton of TS 	<ul style="list-style-type: none"> Lower energy requirements and operation costs (compared to other mechanical dewatering processes) Relatively lower capital required Less complex and therefore easier to maintain Minimal effort needed to shut down the system Can produce very dry sludge (when using high pressures) 	<ul style="list-style-type: none"> High levels of polymers could be needed: 1-10 g kg⁻¹ of solids High odor potential Very sensitive to incoming sludge characteristics Requires a sludge grinder in the feed stream Automatic operation is not advised, in general Workers in the belt press areas could be exposed to pathogens Difficult cleaning of filter clothes
Centrifuge	<ul style="list-style-type: none"> TS in the final product: 4-20% (up to 35% if needed) Solids' recovery efficiency: 85-98% (down to 55% when no polymer used) Energy consumption: 20-300 kWh per metric ton of solids 	<ul style="list-style-type: none"> Easy odor control because the unit is enclosed Versatile (with higher operation complexity) and compact Polymers required at lower concentrations (typical dosage: 2 g kg⁻¹ TS) Efficient even when the other methods are not Low capital cost-to-capacity ratio Can be used where space is limited (reduced footprint) 	<ul style="list-style-type: none"> Requires skilled operators Highly skilled staff required for maintenance Requires a grit removal and possibly a sludge grinder in the feed system Fairly noisy
Thermal drying	<ul style="list-style-type: none"> Requires external sources of heat. Type of heat source depends on the dryer type To dewater sludge to 65% of moisture content, the energy requirements are typically 120 l or 30 kWh per metric ton of solids for fuel oil and electricity, respectively 	<ul style="list-style-type: none"> High TS achievable in final product Dried sludge is usually sanitized Low footprint requirement 	<ul style="list-style-type: none"> High energy consumption Odors and dust may be generated High capital cost May lead to air pollution Requires qualified operating staff and considerable maintenance

Sources: EPA (2000b); Metcalf and Eddy Inc. (2003); National Biosolids Partnership (2005); Bratby (2006); Flaga (2007); Uggetti et al. (2010).

of polymers) of the sludge is required for successful filter press dewatering. This type of filter press is commonly used in industrial applications rather than in municipal wastewater facilities (EPA 2000c) and can only be used as a batch process (each dewatering phase lasts one to three hours).

A **centrifuge** uses centrifugal force to dewater LFS (Table 9). The efficiency of the process depends on factors such as the characteristics of the feed (water-holding structure and sludge volume index), the rotational speed of the centrifugation bowl and so forth. Centrifuges are versatile, i.e. they can be used to thicken or dewater the sludge to different levels, by varying the operating conditions. But they are also complex to operate (for example, start-up and shut down may take an hour during which the speed of the centrifuge will increase/decrease gradually), have high power consumption, high maintenance costs and are fairly noisy (Appendix 8.1, Figure A8.1.5). Polymer addition is recommended in most cases and the needed concentrations are usually less than 4 g kg⁻¹ dry solids (EPA 2000a; Metcalf and Eddy Inc. 2003; Bratby 2006).

Thermal drying removes moisture through evaporation following input of artificial thermal energy (Table 9). Because water evaporation typically requires 800 to 1,100 kWh per metric ton of water evaporated, heat dryers are energy demanding (Huber Technology 2013). Nevertheless, dry TS concentration of up to 90% can be achieved in the final product. In many cases, fossil fuel is far too expensive to be burned solely for sludge drying. When there is a lack of heat, it could be provided from a power-heat cogeneration system, typically generating 0.6 kWh of power for every 1.0 kWh of heat. As power is usually more expensive than heat (typically three times), the benefit/cost ratio is increased (EPA 2006). When heat is available, the heat exchange can be achieved through convection (for example when a hot gas is used), conduction or ultraviolet radiation. Thermal dryers are often used, in order to achieve a high dryness. This is required, e.g. when dried sludge is to be incinerated.

Thermal drying technologies can be grouped into three main types (Chabrier 1999):

- Indirect drying or by contact, where heat is transferred to the wet sludge deposited on a medium, thus allowing the evaporation of the water.
- Direct drying or by convection, where the heat is transferred directly from the hot gas to the sludge and the gas absorbs the humidity of the sludge.
- Mixed drying, i.e. a combination of drying by contact and by convection.

Examples of drying equipment for sludge include drum dryers, flash dryers, fluidized dryers, infrared dryers, disk dryers, etc. One key benefit of thermal drying is that the dried sludge is sanitized and could come in a granulated

state. A case study involving the use of thermal drying is presented in Section 5.2.

3.4 Adjustment to the Moisture Content

In some instances, the raw or the dewatered FS may have a consistency that makes it unsuitable for further processing. Blending with a bulking agent such as sawdust, rice husks or wood chips can reduce the moisture content of the sludge (Montangero and Strauss 2004). This technique is widely applied in Asia to facilitate FS extraction from pit latrines or septic tanks at the time of desludging. Blending is a cheap option for moisture-level adjustment but can be achieved only when such blending materials are available in high quantities and at low cost. It should be noted that blending increases volumes of material to be processed.

3.5 Discussion

In many instances, gravity thickeners have been successfully employed in developing countries to thicken LFS but they present the drawback of requiring long residence time (four to eight weeks) under normal operation, i.e. without chemicals being added. For example, Heinss et al. (1998) discuss extensively the Achimota FS treatment plant (Accra, Ghana) which was recently decommissioned after successful operation over years while other cases are mentioned in Senegal and various Asian countries (Montangero and Strauss 2004; Dodane and Bassan 2014). Such processes are appropriate for decentralized treatment of FS but may show limits when expected to treat large amounts of liquid waste, i.e. for large urban areas, because of the extended land requirement.

When looking for alternatives, one can consider using chemicals to facilitate the coagulation/flocculation and therefore reduce the sedimentation time typically to a day. However, use of chemicals may negatively affect the recycling potential of the dewatered sludge. Gravity belts and rotary drums, i.e. the only thickening technologies which can in principle achieve more than 6% TS in the thickened sludge over a reduced period of time (a few days), could also be used. However, these technologies have rarely been tested at full scale even though some local pilot attempts are mentioned in the literature (e.g. in Malaysia (IWK 2012)). All these mechanized options come with significant cost.

Table 10 present the typical capital, operation and maintenance costs involved for selected technologies applied for wastewater sludge thickening in the United States. Data in this table are only indicative as the situation would be different in other countries and for a different load. To process wastewater sludge, the capital cost for the gravity belt thickeners was US\$ 3.4 million while the operation and maintenance cost was US\$ 4.8 million over the lifecycle (20 years) for a plant with a capacity of 1,650 kg TS h⁻¹ (Kilian and Shimada 2009). Values for the equivalent rotary drum or centrifuge technologies are given as the ratio to that of the gravity belt thickener (taken as a reference).

TABLE 10. TYPICAL RELATIVE COSTS OF SELECTED THICKENING TECHNOLOGIES FOR CONVENTIONAL WASTEWATER TREATMENT PLANT SLUDGE THICKENING.

	GRAVITY BELT ²	ROTARY DRUM	CENTRIFUGE
Capital cost ratio	1	1.17	1.85
Operation and maintenance cost ratio	1	1.02	0.92
Chemicals (%) ¹	75.9	74.0	40.0 [0.5]
Electricity (%) ¹	7.6	7.4	29.9 [3.93]
Labor (%) ¹	2.2	2.0	2.1
Maintenance (%) ¹	14.3	16.6 [1.18]	30.0 [2.01]
Total cost ratio	1	1.09	1.30

¹ The value in brackets corresponds to the ratio between the actual cost and the corresponding value (that of the gravity belt thickener). It is provided only when it is different from 1. The values in italics indicate the exact cost share (in %) for each technology.

² The final concentration of TS is 7% for the centrifuge and 6% for each of the two other processes.

Source: Killian and Shimada (2009).

Data from Table 10 confirm that gravity belts are among the cheapest mechanical thickening technologies. But they could still remain inaccessible for developing countries unless there is a strong governmental will to improve sanitation.

Following thickening of LFS, an extra step is often required to further reduce the moisture content through addition of a bulking material or any mechanical/non-mechanical dewatering process. Table 11 presents a comparison between selected drying processes. It shows that drying beds are in general the cheapest to implement but require extensive land area. In developing countries, several successful cases involving use of drying beds have been identified (e.g. in the Cambérène FS treatment plant, Senegal). Because they require little attention, they have proven to be manageable by local authorities or communities. On the other hand, mechanical methods such as centrifuges are much more expensive than non-mechanical systems and may only be used under specific conditions, i.e. when skilled staff

is available while space is not sufficient for other cheaper processes to be implemented (e.g. for a mobile treatment unit, or a treatment unit in a confined area). Use of thermal drying in such movable plants is reported in a case study (Section 5.2, Case 2) but it is unclear how effective the other mechanical technology could be for LFS treatment.

Operating costs of technologies are mainly affected by energy consumption, input (e.g. polymers) demand and staff cost. Figure 12 presents the energy demand for some technologies. It shows that drying beds, gravity thickeners and blending are the least demanding in terms of energy while thermal dryers have the highest consumption. Figure 13 shows the qualitative scale of variation of land demand for thickening and dewatering technologies. Non-mechanical processes (drying beds and gravity thickeners) require extensive land while centrifugation is suitable for reduced available land. In between, depending on space availability, devices such as gravity belts and rotary drums may be appropriate.

TABLE 11. MAIN CHARACTERISTICS OF THE SLUDGE DEWATERING PROCESS.

CHARACTERISTICS	DRYING BED	BELT PRESS	CENTRIFUGE
Land requirements	+++	+	+
Energy requirements	-	++	++
Implementation cost	+	++	+++
Operational complexity	+	++	+++
Maintenance requirements	+	+++	++
Complexity of installation	+	++	++
Influence of climate	+++	+	+
Sensitivity to LFS quality	+	++	+++
Sensitivity to type of LFS	++	++	+
Chemical product requirement	+	+++	+++
Dewatered sludge removal complexity	++	++	+
Level of dryness	+++	++	++
Odors and vectors	++	+	+
Noise and vibration	-	++	+++

Source: Adapted from von Sperling and Chernicharo 2005.

FIGURE 12. ENERGY REQUIREMENT FOR SELECTED DEWATERING/DRYING PROCESSES.

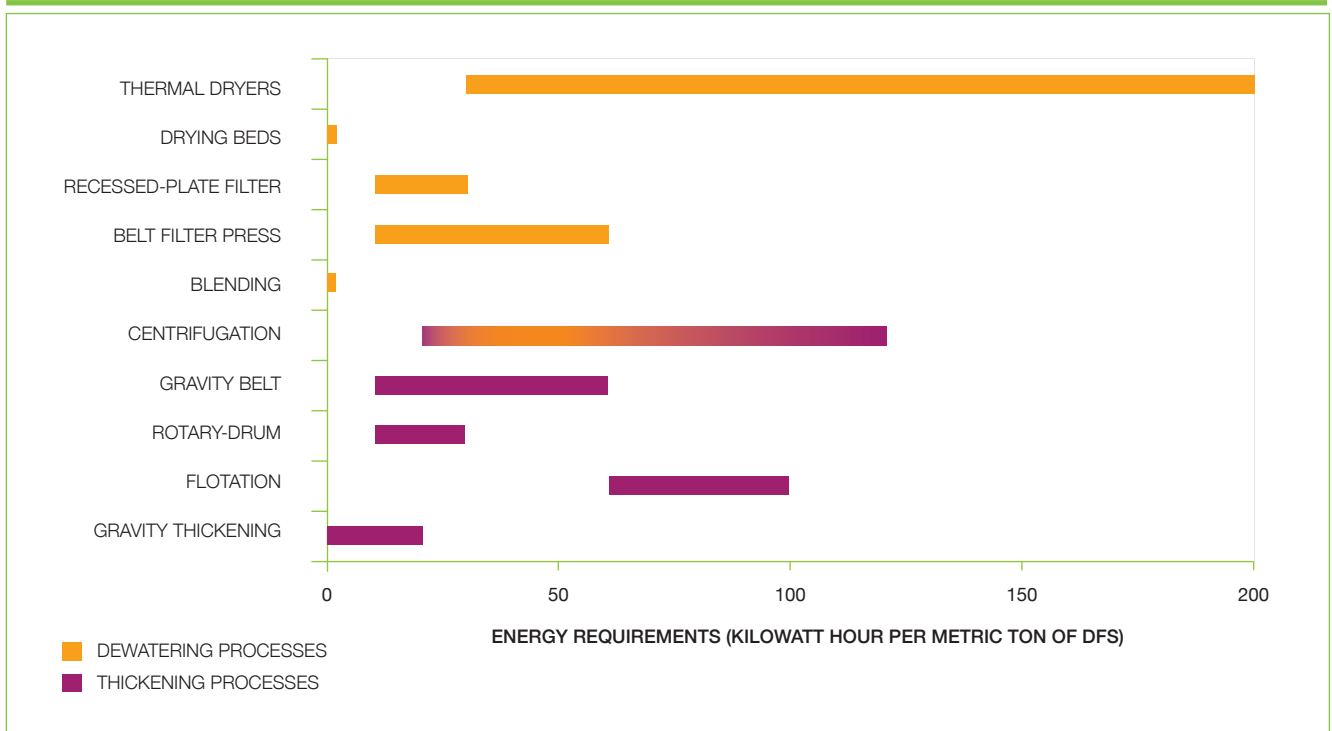
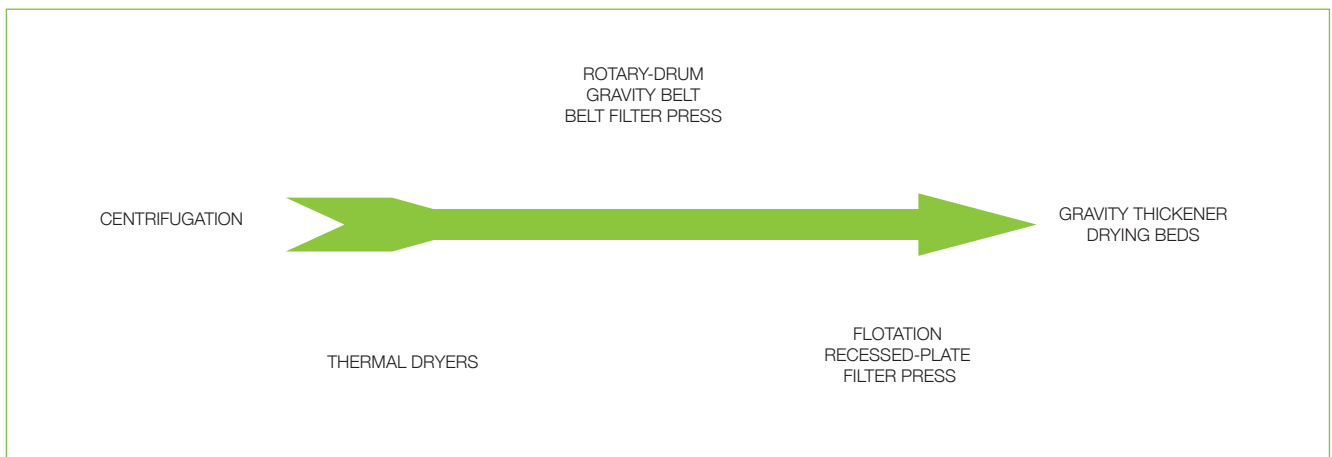

FIGURE 13. LAND REQUIREMENT FOR DEWATERING/DRYING PROCESS IMPLEMENTATION.



4 PROCESSES FOR LIQUID EFFLUENT TREATMENT

The liquid effluent from the dewatering process, if any, should be monitored. Planted drying beds may not generate water when the evapotranspiration rate is high but for drying beds, 39-79% of LFS volume typically emerges as percolate (Cofie et al. 2006). Often, this liquid effluent requires additional treatment to meet discharge quality standards. A low-cost technology (waste stabilization ponds; wetlands; etc.) should therefore be implemented. Filtered or settled LFS has variable characteristics, but sometimes, its composition is similar to that of conventional sewage wastewater, except for the high COD rate (Table 12). The treated effluent can be reused for watering compost windrows at the early stages of composting or as irrigation water in peri-urban farming provided its quality meets the standards set for unrestricted cultivation (WHO 2006).

4.1 Waste Stabilization Ponds

Waste stabilization ponds (WSP) are a good option for wastewater treatment in developing countries because of the low capital and O&M costs (SSWM 2013b). In general, they consist of a series of ponds named after their function – anaerobic, facultative or maturation – in which water under treatment is allowed to stay for 20 to 180 days, thereby reducing organic, nutrient and pathogen loadings through both sedimentation and biodegradation under anaerobic, anoxic and/or aerobic conditions (Figure 14). To prevent water infiltration, the ponds could be lined with clay, asphalt or any impervious material. In the case of LFS dewatering/thickening effluent, features of WSP will vary with its characteristics. For instance, effluent coming from drying beds is already well clarified and may not require treatment in a separate anaerobic pond. However, effluent from settling tanks may still be high in SS and therefore could require such

TABLE 12. COMPARISON BETWEEN TYPICAL SEWAGE WASTEWATER AND LFS DEWATERING/THICKENING EFFLUENT.

PARAMETERS	BOD (MG L ⁻¹)	COD (MG L ⁻¹)	SS (MG L ⁻¹)	TS (MG L ⁻¹)	TN (MG L ⁻¹)	HELMINTH EGGS (NUMBER L ⁻¹)	SOURCE
Sewage wastewater in PRESEC school, Ghana	774-868	1,343-1,357	390-480	1,180-1,420	-	-	IWMI (unpublished)
Sewage wastewater in Kumasi, Ghana	285	696	-	-	43 ¹	-	Awuah et al. (2004)
Effluent from sand filter beds in Ghana	870-1,350	3,600-5,600	290-600	5,700-5,100	-	0	Cofie et al. (2006)
Effluent from sand filter beds in Senegal	-	3,600	1,900	2,500	-	-	Dodane and Ronteltap (2014)
Effluent from a settling tank (Ghana)	150	650 3,000	1,000	-	104 ²	-	Koné and Strauss (2004)
Effluent from planted drying beds (Cameroon)	-	250-500	100-300	1,500-4,000	100-200 (50-150 ²)	0	
Effluent from Slamson dewatering unit (Ghana) ³	172	-	1,726	-	92	-	Slamson (2014)

¹Inorganic N; ²NH₄⁺-N; ³design parameters.

a treatment. The volumes of ponds and type of maintenance required will be determined by the effluent characteristics which can be highly variable as shown in Table 12.

The anaerobic pond (typical BOD loading rate: 159-350 g m⁻² of pond surface per day or 100-300 g m⁻³ of pond per day) (hydraulic retention time: one to seven days) is usually 2 to 5 m deep and primarily designed to allow removal of

SS, anaerobic degradation of organic matter (60 to 85%), but could also inactivate viruses, bacteria, helminthes and other pathogens (Kayombo et al. 2004; SSWM 2013b). The biogas resulting from the anaerobic decomposition could be collected and reused when the pond is covered. In that case, longer residence time should be allowed (20-50 days) (SSWM 2013b). The sludge accumulating in the pond must be removed periodically, typically once every three to five

FIGURE 14. TYPICAL SCHEME OF A WASTE STABILIZATION SYSTEM: AN ANAEROBIC, FACULTATIVE AND MATURATION POND IN SERIES.

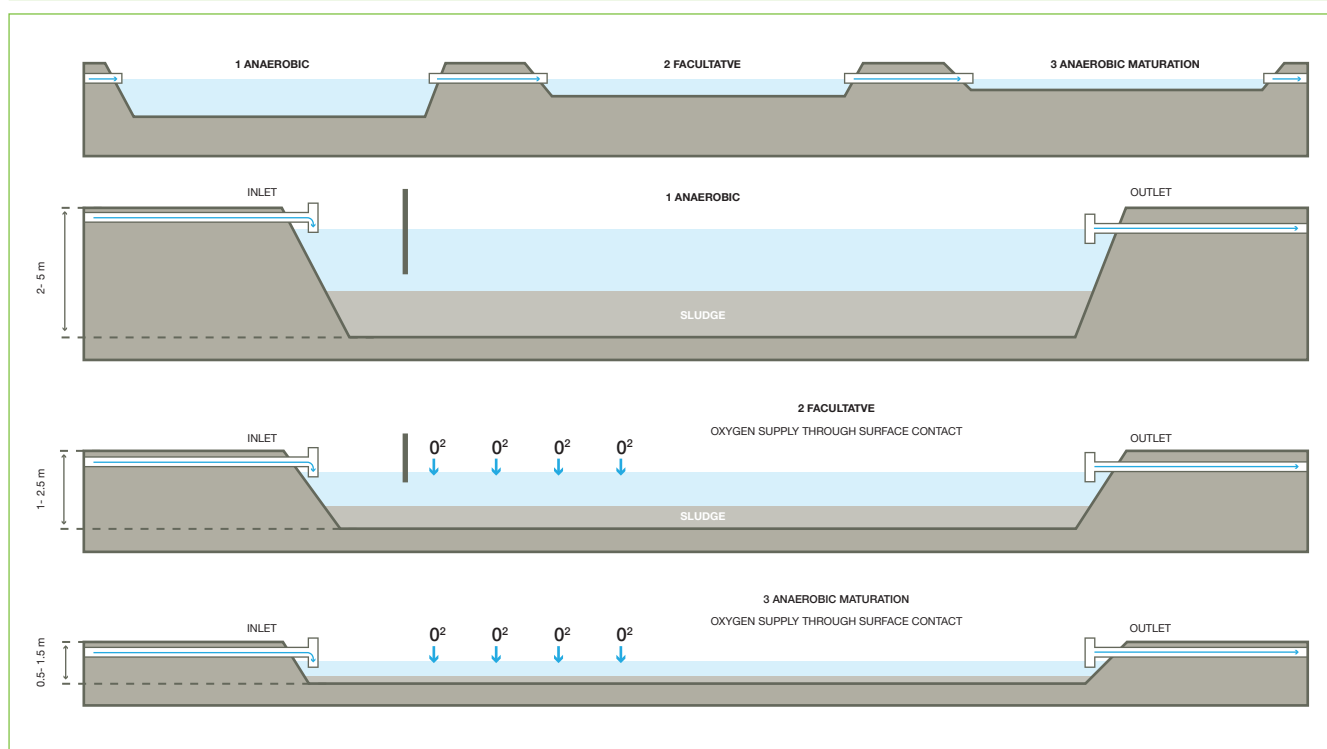

Source: SSWM (2013b).

years (Heinss et al. 1998). The rate of sludge accumulation rate in ponds treating conventional wastewater was found to be 21-36 l per capita per year in Mexico (AIT 2012; Nelson et al. 2004). Rates for LFS treating ponds should be in a similar range. Anaerobic ponds do not allow, in general, growth of algae.

The facultative pond (typical BOD loading rate: 10-49 g m⁻² of pond surface per day) is an algae-covered anoxic pond with 1 to 2 m depth (hydraulic retention time: five to 30 days). It serves to allow little sedimentation of solids (the liquid to be treated must nearly be solid-free) while degrading dissolved organic matter (80-95%), nutrients (e.g. ammonia: 80-95%, in part through volatilization) and inactivating pathogens as a result of the pH increase (caused by algae development). Because of the algae they contain, these ponds are often green in color (Kayombo et al. 2004). Other plants such as duckweed and water lettuce could be grown in these ponds for a commercial/recycling process if the water quality permits (Awuah et al. 2004; Koné 2002). Typically, growth rate of water lettuce is 18.2 kg dry weight m⁻² of pond per year when treating low-strength sewage wastewater.

The aerobic or maturation pond (typical BOD loading rate: 67 g m⁻² of pond surface per day) serves to remove the remaining pathogens (via solar disinfection and pH), nutrients and SS (hydraulic retention time: 15 to 20 days) (Mara et al. 1992; Tilley et al. 2008). This pond can also be used for algae or fish harvesting.

Additional features of waste stabilization ponds are given in Table 13.

The size of each of these ponds is determined by the quality of the effluent to be treated as well as the desired performance. Evaporation will also contribute to reducing

the amount of water available after treatment. Typically, the cost of a WSP unit is US\$ 100 to US\$ 420 per population equivalent. This variability depends on soil characteristics which affect excavation costs (Weissenbacher et al. 2014). On the other hand, a treatment plant treating 47 m³ day⁻¹ of LFS and composed by a gravity thickener, followed by sand drying beds for the thickened sludge and WSP (i.e. one anaerobic pond plus one facultative pond) would cost, in Togo (West Africa), about US\$ 120,000. In this case, the addition of an extra maturation pond would result in a US\$ 30,000 extra cost (WSA 2009).

4.2 Constructed Wetlands

There are three types of constructed wetlands for wastewater treatment. In the free water surface wetland (FWSW), the treated water flows horizontally and above the ground while in the subsurface flow wetland (SSFW), the water flows horizontally and underground (5 to 15 cm below the surface). The vertical-flow constructed wetland (VFCW) operates as a planted drying bed. One major difference between VFCW and FWSW/SSFW wetlands is of course the direction of the flow path of the wastewater. This results in intermittent aerobic-anaerobic conditions in the VFCW while the other two systems are always operating under aerobic conditions. On the other hand, the horizontal-flow systems are more sensitive to clogging, which may be caused by high SS concentration in the liquid to treat. So, they should be used mostly to remove dissolved contaminants while the VFCW is effective in removing suspended solids. FWSW, SSFW and VFCW can be combined in a hybrid unit to allow proper treatment of wastewater. In wetlands, plants facilitate oxygen transfer and support bacterial attachment (SSWM 2013c; Mthembu 2013; Tilley et al. 2008). Additional features of wetlands are given in Table 13. Design of FWSW and SSFW is similar to that of planted drying beds (a variant of VFCW) discussed earlier (Section 3.3.1.3).

TABLE 13. KEY FEATURES OF SELECTED TREATMENT OPTIONS FOR LIQUID EFFLUENTS FROM DEWATERING UNITS.

	KEY FEATURES	ADVANTAGES	DISADVANTAGES
Waste Stabilization Ponds	<ul style="list-style-type: none"> Consists of bioreactors in series operating under anaerobic, facultative and aerobic conditions BOD removal: 80-95% Residence time: 20-60 days 	<ul style="list-style-type: none"> Low construction costs Low O&M costs; main O&M requirement includes weeding (to prevent breeding of mosquitoes) and removal of scum Low energy demand Appropriate for treating high-strength effluent 	<ul style="list-style-type: none"> Requires large land area May promote breeding of insects Odor may be generated in some cases Well suited for tropical and subtropical countries
Wetlands	<ul style="list-style-type: none"> Organic loading rate: 30-110 g COD m⁻² d⁻¹ (typical: 75 gBOD₅ m⁻² d⁻¹) Hydraulic residence time: typically 3-6 days 	<ul style="list-style-type: none"> Does not require chemicals, energy or high-tech infrastructure Suited for combination with aquaculture or sustainable agriculture (irrigation) Good control of odor Low construction, O&M costs High reduction in BOD, SS and pathogens possible Attractive landscape features 	<ul style="list-style-type: none"> Requires large land area Delayed operational status (vegetation establishment needed for peak removal efficiency might take 2-3 years) Pretreatment of the effluent may be required to prevent clogging of the filter bed Not very tolerant to cold climates

Source: Waterbiotech (2013); SSWM (2013b); SSWM (2013c); Masi (2012).

Investment cost of wetlands is influenced by the availability of sand/gravel and cost of land (Hoffmann et al. 2011). Specific data for treatment of settled/filtered LFS are not readily available. However, costs from sewage wastewater treatment could be used for indication. It could range from € 10,000 to € 18,000 for a 120 population equivalent (p.e.) plant (surface area of 30-60 m²).⁴ It is € 150,000 to € 600,000 for a 1,000 to 3,500 p.e. plant (i.e. flow of 350 m³ day⁻¹ and surface area of 1,500-4,500 m²). For much larger plants, investment cost could typically reach € 3,800,000 for a plant treating 27,000 p.e. wastewater. The operating cost per year is typically 1 to 2% of investment (Masi 2012).

4.3 Discussion

Unlike the stabilization ponds which can facilitate solid and dissolved contaminants removal, constructed horizontal flow wetlands (SSFW and FWSW) are designed mainly for dissolved contaminants. For filtered/settled LFS, ponds are therefore more resilient to a variation in feed quality (e.g. TS content) than horizontal flow wetlands. Nevertheless, the effluent from these two processes is relatively rich in nutrients and can be reused in agriculture and aquaculture (Rose 1999). Although stabilization ponds and constructed wetlands require relatively more land and space, they have the advantage of low operating costs (SSWM 2013b, 2013c) as shown in Figure 15 which presents an overview of costs generated by selected sewage wastewater treatment plants in West and North Africa.

In the event that WSP or wetlands are not suitable (e.g. because of a lack of sufficient space), cost-effective advanced processing methods could be envisioned (Waterbiotech 2013; Libhaber and Orozco-Jaramillo 2013).

5 TREATMENT PROCESSES

5.1 Conventional Method: Composting

Composting is often considered as a low-cost and easy-to-operate technical option for sludge sanitization in low- and middle-income countries. Composting is a process which involves microbial degradation of organic solid waste. It can be achieved under aerobic (i.e. with oxygen) or anaerobic (i.e. without oxygen) conditions and even alternate between the two modes. To date, open/aerobic systems such as windrows and static piles (low cost) have been used for DFS composting. They are preferred to other methods because they allow temperatures to rise during composting and material to be sanitized more quickly. Heat remains, indeed, the most reliable sanitization method (Vinnerås 2007). Composting methods which do not result in sufficient temperature increase (e.g. vermicomposting) should be avoided as much as possible because they require longer periods for compost products to be sanitized.

Heap (open) composting (Figure 16) is appropriate for FS. When composting at a small scale (e.g. 200 kg per heap),

FIGURE 15. OVERVIEW AND COST DISTRIBUTION OF SELECTED SEWAGE PLANTS.

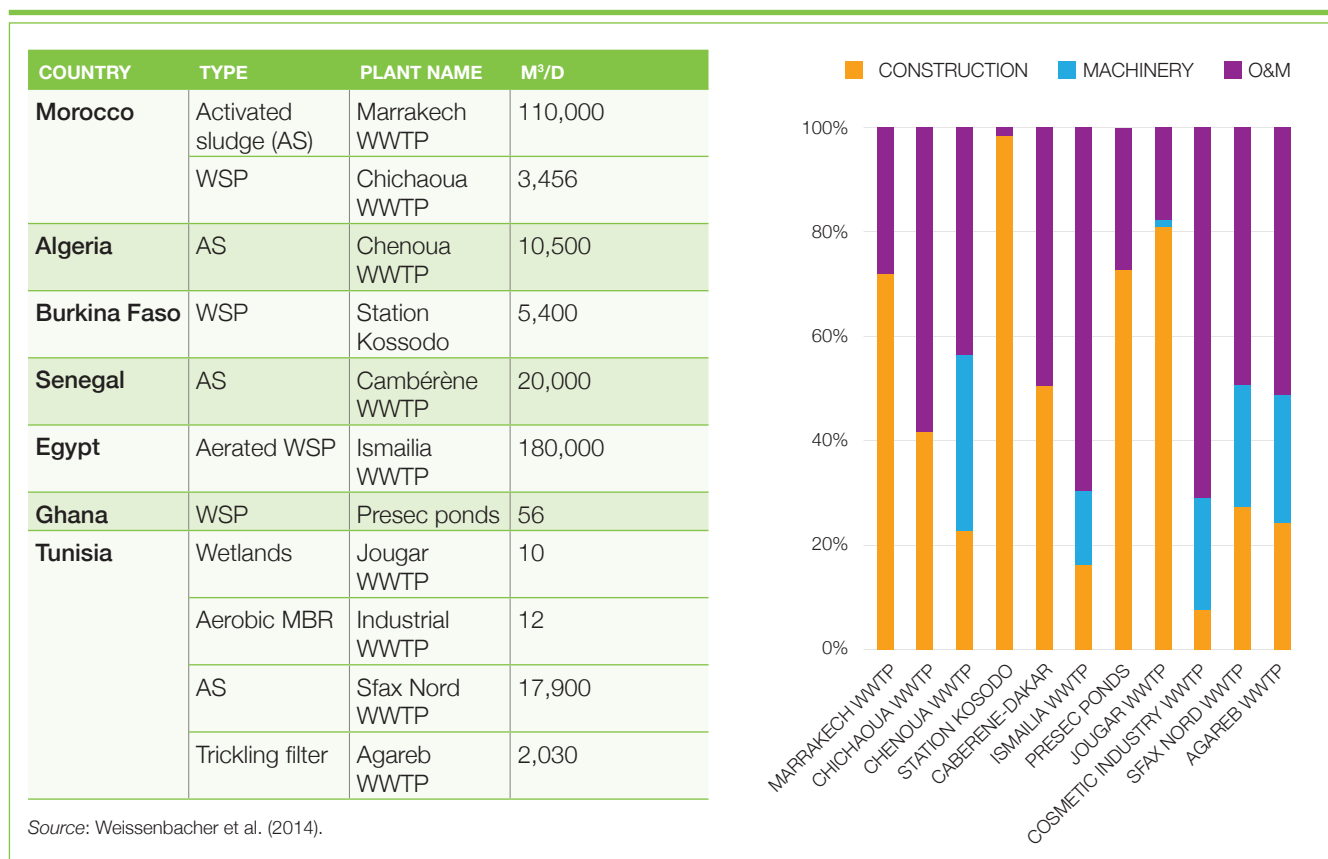

⁴ 1 p.e. = 60 g BOD day⁻¹, 15 g TKN day⁻¹ and 4 g TP day⁻¹.

FIGURE 16. HEAP COMPOSTING OF DEWATERED FS.



Source: IWMI (2012).

the vessel must be insulated to ensure that sufficiently high temperatures are achieved for pathogen inactivation. Otherwise, the heap/pile must be high enough to allow good insulation (Vinnerås 2007). The minimum windrow size must be 2-3 m³ while the minimum composting duration, to comply with World Health Organization (WHO) guidelines for safe recycling of FS, is two months (Koné et al. 2007). During composting, aeration is ensured through regular turning of the feedstock. Additional factors influencing the composting process include the carbon to nitrogen (C/N) ratio (20-35 initially) of the waste, moisture content (50-60% ideally), particle size (preferably reduced), pH (6.5-9.6 during the thermophilic stage) and type of micro-organisms involved in the process.

It is usually easy to meet most of these requirements during composting of DFS; e.g. the DFS solids can be manually broken down to ensure a suitable reduced particle size and the pH is also often satisfactory. But DFS is rich in nitrogen and therefore does not always satisfy the C/N ratio requirement

which leads to high N losses during composting or insufficient temperature increase during the thermophilic composting stage. To minimize this phenomenon, it is advisable to compost DFS with carbon-rich waste which must be carefully selected. The resulting process is termed co-composting.

DFS can be co-composted with any organic material which has high carbon content. However, the type of added material will affect the duration of the co-composting. Typically, with market waste, the minimum duration is three months, while with sawdust, it reaches four months. In addition, incoming organics should not have contaminants that negatively affect environmental and human health in the long term. To ensure that the quality of the produced compost is acceptable, it must be confirmed that any heavy metal content meets safety standards. Under normal circumstances, FS contains acceptable levels of heavy metals, i.e. within the acceptable range for reuse, according to current standards (Nikiema et al. 2013; Cofie and Adamtey 2009; Kengne et al. 2009; Heinss et al. 1998). However, when it is being co-composted with other waste types, caution must be taken to ensure that the added material is also acceptable.

The compost/co-compost must be stabilized and matured (a minimum of two to four months required, depending on the feedstock, composting technology and management technique) before being used on agricultural land. Stability is confirmed through the final C/N ratio, which must be ≤ 25 (EPA 2006) and a final nitrate/ammonium ratio of 2.00-6.25 (Fuchs 2002; Bernal et al. 1998). On the other hand, maturity can be confirmed through determination of the seed germination index (GI), which must lie in the range of 50-80% (Bernal et al. 1998; Tiquia and Tam 1998). Finally, one must ensure that the viable helminth eggs' content of the compost does not exceed the WHO standard of 1 *Ascaris* egg gTS⁻¹ while the *E. coli* level must remain below 1,000 CFU g⁻¹ (WHO 2006).

Case Study: Composting and Co-Composting in Accra, Ghana

The DFS used in this study was obtained from an unplanted drying bed as described in Section 3.3.1.1. It was combined for co-composting either with sawdust produced from a local timber sawmill or organic market waste at a mass ratio of three parts of organic waste per part of DFS. This mass ratio was selected because the resulting co-compost contained higher N and C needed for plant growth and for soil organic matter respectively, compared to other mixing ratios (Cofie et al. 2006). The initial C/N ratio was about 25-47 depending on the type of waste added to the DFS. Sorted organic market waste was obtained from Madina market (Accra). Before use, excess water in the OMW was removed by sun-drying on a platform for four days.

The typical DFS characteristics of co-compost feedstock in Ghana are given in Table 14.

TABLE 14. TYPICAL CHARACTERISTICS OF CO-COMPOST FEEDSTOCK IN GHANA.

PARAMETERS	UNIT	DEWATERED FECAL SLUDGE	MARKET WASTE
pH		7.45 ± 0.04	9.04 ± 0.37
Acidity	cmol kg ⁻¹	-	2.15 ± 1.48
Moisture	%	35.44 ± 5.23	68.05 ± 1.34

CONTINUED

TABLE 14. TYPICAL CHARACTERISTICS OF CO-COMPOST FEEDSTOCK IN GHANA. (CONTINUED)

PARAMETERS	UNIT	DEWATERED FECAL SLUDGE	MARKET WASTE
Carbon	%	12.30 ± 5.24	32.81 ± 19.08
Nitrogen	%	2.66 ± 0.02	1.25 ± 0.93
C:N		8.39 ± 3.39	28.49 ± 6.00
K	%	0.61 ± 0.05	0.94 ± 0.03
P	%	1.24 ± 0.03	0.54 ± 0.07
<i>E. coli</i>	10 ⁸ CFU g ⁻¹	4.07 ± 2.04	5.70 ± 3.54
Total bacteria	10 ⁶ CFU g ⁻¹	6.10 ± 1.05	2.71 ± 2.40
Total fungi	10 ⁶ CFU g ⁻¹	4.67 ± 1.54	5.75 ± 5.02
Clostridium	10 ⁶ CFU g ⁻¹	4.93 ± 1.48	4.50 ± 3.82
Helminth	eggs/gTS	25–83	-

Sources: IWMI (2013); Cofie et al. (2009).

Heap composting was applied in this case. The characteristics of the initial heaps are provided in Table 15 while photo examples are given in Figure 17. Heaps were turned, and moistened to the required levels at three-day intervals during the first month and at a one-week interval later (Figure 18). This turning frequency, during earlier work, ensured uniform sanitization and composting (Figure 19).

TABLE 15. CHARACTERISTICS OF COMPOST HEAPS ON DAY 1.

COMPOST HEAP	HEAP WEIGHT (KG)	HEAP HEIGHT (M)	HEAP CIRCUMFERENCE (M)	VOLUME HEAP (M ³)	VOLUME OF H ₂ O ADDED (L)	INITIAL TEMP (OC)
DFS:SD (1:3)	800	0.90	9.25	2.8	1,196*	31.8
DFS:MW (1:3)	1,000	0.80	7.35	2.0	156	32.0
DFS only	1,000	0.87	8.90	2.6	533	33.3

* Sawdust requires a lot of water to reach 65% moisture content, hence the large volume of water used. In the heaps, the excess water was collected and reused on the following days during turning.

Source: IWMI (2011).

FIGURE 17. FORMATION OF THREE COMPOST HEAPS (ACCRA, GHANA).

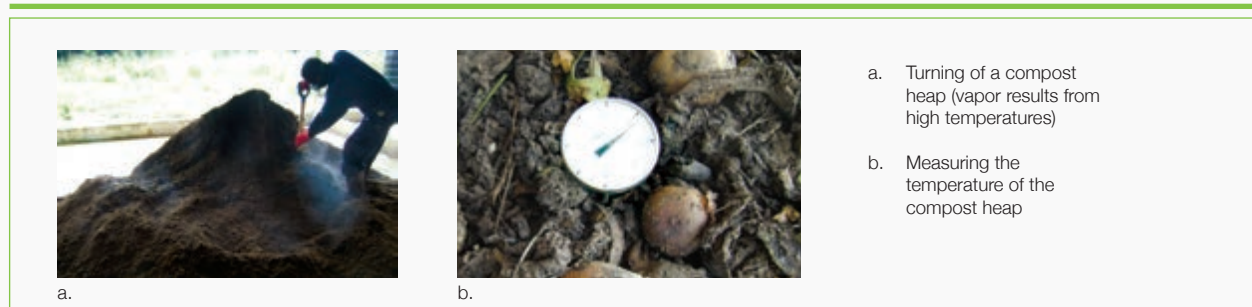

Source: IWMI (2011).

FIGURE 18. MONITORING OF A TYPICAL HEAP (ACCRA, GHANA).

- Turning of a compost heap (vapor results from high temperatures)
- Measuring the temperature of the compost heap

Source: IWMI (2011).

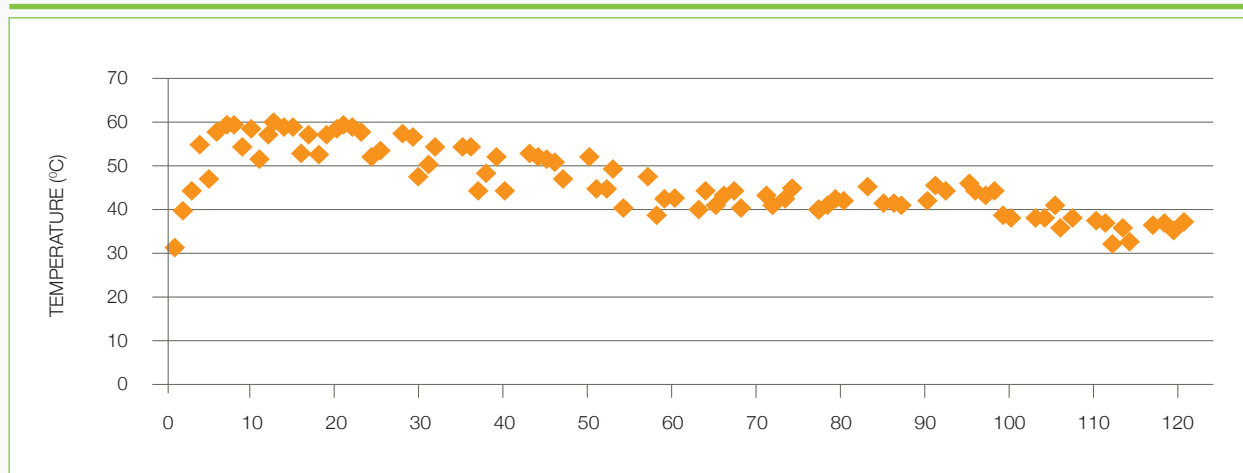
FIGURE 19. TEMPERATURE CHANGES DURING CO-COMPOSTING OF DFS:SD (1:3) HEAP.



Source: IWMI (2011).

Under these conditions, the required maturation time was about 60 days for C-DFS (compost of DFS) and 120 days for C-SDFS (co-compost of DFS and sawdust). After production, both materials were spread on the platform to be sun-dried to reach moisture content of less than 10%. The N, P and K levels of the final composts were 12-18 mg g⁻¹, 3-11 mg g⁻¹ and 2-5 mg g⁻¹, respectively (Nikiema et al. 2013). During similar experiments in Kumasi, it was confirmed that 90-100% removal of Ascaris eggs was reached after 80 days of co-composting with market waste.

5.2 Pelletization of Dewatered Fecal Sludge or Composts

The production of pellets is meant to increase the marketability of FS-based products by addressing technical, social and environmental challenges linked with FS. Pellets are small particles often created by compressing the original material. The required characteristics of the compost pellets are:

- Durability: Not being crushed during handling, especially transportation;
- Malleability: Easily spread, even mechanically, with no/little dust generation;
- Good/constant nutrient content.

There are two main methods involved in the formation of pellets: extrusion and compaction. Pelletizing equipment using extrusion are called extruders while a variety of pelletizers use different forms of compaction (such as disk pelletizers, granulators); they are described in Table 16.

Pelletization of vegetable compost has been practiced for years in developing countries (e.g. Nigeria, India, China). However, pelletization of FS-based products appears to be a new area with limited cases reported so far. In the sections below, some all-in-one systems are presented.

TABLE 16. TYPES OF PELLETIZERS.

TYPES AND CHARACTERISTICS	DISK PELLETIZER	EXTRUDER PELLETIZER
Description	<ul style="list-style-type: none"> ▪ The compost is fed between the disks (1 or 2) and/or roller, and rotation forces compost into disk holes. It requires low moisture (typically 20-30%). 	<ul style="list-style-type: none"> ▪ It has a barrel into which the raw material is forced by a screw into a die. It requires higher moisture levels (typically 40%).
Advantages	<ul style="list-style-type: none"> ▪ It does simultaneous grinding 	<ul style="list-style-type: none"> ▪ The temperature can be controlled by adjusting the pressure ▪ The shapes of pellets are easily changed by replacing the die
Limits	<ul style="list-style-type: none"> ▪ It can be severely damaged by foreign bodies (e.g. long fibers and small stones) 	<ul style="list-style-type: none"> ▪ It is easily blocked by foreign bodies or when the product has low fluidity
Key operating parameters¹	<ul style="list-style-type: none"> ▪ Feeding rate 	<ul style="list-style-type: none"> ▪ Speed of the screw ▪ Moisture content of the product

¹ Depends on the feed properties.

Sources: Hara (2001); Nikiema et al. (2013).

Case Study 1: The IWMI-developed Process

The process optimized by IWMI is presented in Figure 20. It is easy to implement because it uses locally available material and is expected to increase the marketability of the FS-based products while also addressing health and environmental challenges generated by FS (Table 17). The specific components used for the pilot plant are presented in Figures 21, 22 and 23.

FIGURE 20. IWMI PROCESS FOR PELLETIZATION.

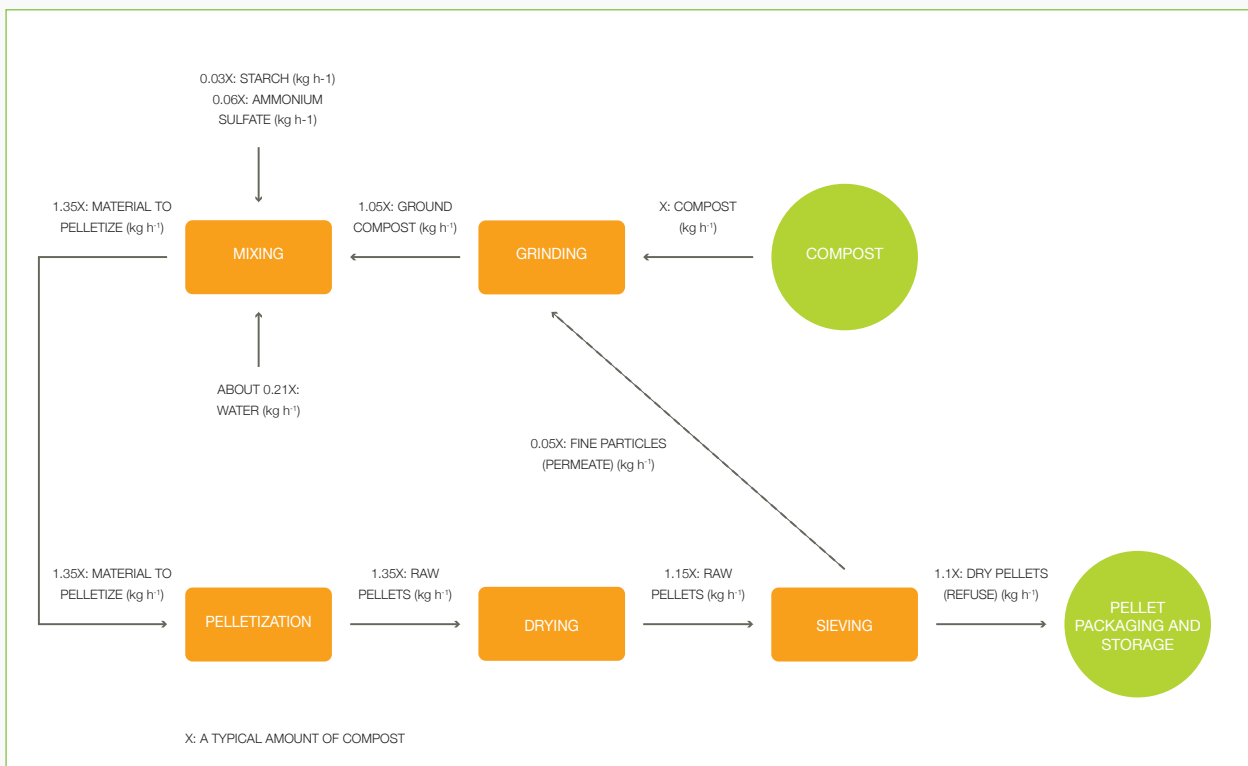

TABLE 17. KEY FEATURES, ADVANTAGES AND DISADVANTAGES OF THE IWMI PELLETIZING PROCESS.

KEY FEATURES	ADVANTAGES	DISADVANTAGES
<ul style="list-style-type: none"> Converts raw FS from pit latrines, public toilets and household septic tanks into enriched and pelletized compost Processing time^a: 1-7 days^b Up to 57 kWh per metric ton of pellets 	<ul style="list-style-type: none"> Low-cost technology, with limited energy requirement Versatile, i.e. applicable to various liquid waste types Equipment is locally available Easy O&M Pellets are made from stabilized composts 	<ul style="list-style-type: none"> High footprint due to drying and composting Risk of odor/nuisance generation during LFS drying and composting High processing time compared to other non-composting methods Could be labor-intensive

^a For pelletization only. If starting from LFS drying and including all subsequent phases, 70-150 days per batch may be needed.

^b Depend on the drying method and weather conditions.

Source: IWMI (2012)

FIGURE 21. A) THE GRINDER, B) RAW DFS, C) C-DFS NOT GROUND, AND D) GROUND C-DFS.



Source: IWMI (2012)

FIGURE 22. DFS COMPOST ENRICHMENT-MIXER (A) SIDE, (B) TOP VIEWS, AND (C) NEWLY PRODUCED ENRICHED DFS COMPOST.



Source: IWMI (2012).

FIGURE 23. PELLET PRODUCTION – A) PELLETIZER BEING OPERATED, B) NEWLY PRODUCED PELLETS, AND C) FINAL PELLETS (AFTER DRYING AND SIEVING).



Source: IWMI (2012).

The DFS in this case was obtained as described in Section 3.3.1.1. The compost and co-composts were obtained as described in Section 5.1. Therefore, two organic materials, i.e. composted dewatered fecal sludge (C-DFS) and co-composted dewatered fecal sludge with sawdust (C-SDFS) were generated. They were ground with a hammer mill machine constructed by the Council for Scientific and Industrial Research (CSIR), Ghana (Figure 21). Grinding of compost is recommended before pelletization to protect the pelletizer from any incoming coarse material and to ensure adequate binding. Part of the ground product was enriched to form enriched C-DFS (EC-DFS) and enriched C-SDFS (EC-SDFS). So, 62 g and 86 g of ammonium sulfate ($[(\text{NH}_4)_2\text{SO}_4]$) were dissolved in a reduced amount of water which was then incorporated using a mixer to each a kilogram of the ground C-DFS or C-SDFS, respectively, increasing their respective N content to 3% (Figure 22).

During pelletization (Figure 23), binding material (or binder) can be used even though not always required. The binder limits breakdown of the pellets until they are applied to the soil and is relevant when the material is difficult to pelletize (e.g. for sawdust co-compost). The decision to use a binder should be taken while considering market behavior (e.g. are users willing to purchase the product even with a certain percentage of fine particles?) and the cost implications. One of the most important characteristic of a binding material is plasticity, i.e. its ability to undergo permanent deformation under load. Criteria to be considered for selection of a binder include binding ability/strength (to avoid the use of high amounts of binder), availability of binder, its handling and storage requirements, ease of use during pelletization and cost as well as its impact on pellets; for example disaggregation rate, nutrient content, etc. (Nikiema

et al. 2014). Theoretical⁵ examples of binders include dry starch, dry sugars, beeswax, primary clay, secondary clay (bentonite), gums, alginates and lignosulfonates.

Preliminary investigations revealed that cassava starch and clay were possible binding materials that can be used for pelletization in Ghana given their availability (Nikiema et al. 2014). Comparing the performance of these two materials, i.e. cassava (varieties: Ankrah and Yepesivi) starch and 1:1 kaolinite clay, (concentration: 0-10% in mass) for pelletization of C-SDFS led to identification of cassava starch as the most appropriate binder while the added concentration was set at 3%. Before use, starch must be pregelatinized to increase its binding ability (pregelatinized starch could also be purchased separately). The pregelatinization process involved combining the required amounts of water ($85 \pm 5^\circ\text{C}$) with dry starch under manual stirring. This led to the formation of a paste which, in fact, is a mix of water and pregelatinized starch. It was then incorporated into each organic material (C-DFS, C-SDFS, EC-DFS, EC-SDFS) to produce pellets.

The diameter of the pellets produced was 7.5-7.7 mm. This could be attributed to the uniform die hole size of 8 mm, with the small variation being the result of the contraction of the pellet following drying. The IWMI pelletization process was influenced by several factors such as the moisture content of pelletizer feedstock, the binder type and concentration, the raw materials used in composting and so forth. These must be optimized on a case-by-case basis. Table 18 presents the moisture requirements of various composts as well as the characteristics of resulting pellets. The followed pelletization response parameters included amount of fine materials, generated during the processing which must be recycled, length distribution of pellets, stability of pellets and pellet disintegration rate in soils and water. When pelletizing DFS compost, the mass ratio of pellets formed to raw DFS is about 0.66. In the case of DFS co-compost, the mass ratio is higher, typically reaching up to 2.2 when co-composting is done with organic waste (market waste or sawdust) in the mass ratio of three parts of organic waste for one part of DFS.

TABLE 18. OPTIMUM MOISTURE CONTENT AND CHARACTERISTICS OF PRODUCED PELLETS.

PARAMETER		C-DFS ¹	EC-DFS ¹	C-SDFS ¹	SIGNIFICANT FACTORS
Optimal moisture content (%) when using starch		27-31	18-25	39-46	<ul style="list-style-type: none"> ▪ Type of pelletized material ▪ Type of binder ▪ Concentration of binder
Percentage of fine materials generated by the process		10	8	19	<ul style="list-style-type: none"> ▪ Starch concentration ▪ Moisture content ▪ Type of pelletized material
Pellet length distribution (%)	0.5-1.0 cm	71	21	-	<ul style="list-style-type: none"> ▪ Starch pretreatment method ▪ Type of pelletized material
	1.0-1.5 cm	24	49	-	
	1.5-2.0 cm	4	24	-	
	2.0-2.5 cm	1	4	-	
Bulk density for dried materials	Raw	0.71	0.71	0.37	<ul style="list-style-type: none"> ▪ Type of pelletized material ▪ Starch pretreatment method ▪ Moisture content
	Ground	0.77	0.77	0.39	
	Pelletized	> 0.92	> 0.90	> 0.47	
Disintegration time in the presence of water²		-	54 h	-	<ul style="list-style-type: none"> ▪ Starch content ▪ Type of pelletized material
Stability (% of pellets keeping a length > 5 mm after shaking [300 motion min⁻¹, 2 h])³		87-90	88-98	92 (typical value)	<ul style="list-style-type: none"> ▪ Type of pelletized material ▪ Binder concentration ▪ Moisture content

¹ C-DFS: compost of DFS; C-SDFS: co-compost of DFS with sawdust (1:3 mass ratio); EC-DFS: enriched C-DFS. Enrichment is performed after the C-DFS is ground.

² This test measures the minimum time needed for pellet particles to disintegrate in the presence of water. Fifty pellets (length: 14-18 mm) were placed in a transparent plastic container (height: 14 cm; diameter: 10.8 cm) and then 200 cm³ of water were added. The time needed for the pellets to disintegrate was recorded.

³ This test was designed to simulate the handling challenges that pellets might undergo, from production stage to usage. In the absence of standard equipment, a shaker (HS 501D, IKA-WERKE) was used. Therefore, 120 g of pellets were placed into a transparent glass bottle (height = 12.7 cm; diameter: 7.0 cm) until it was half full and was then shaken at 300 motions per minute for up to two hours. The stability (%) represents the mass percentage of pellets maintaining more than 5 cm of length.

Sources: IWMI (2012); Nikiema et al. (2013).

⁵ These materials are known to express good binding abilities under various conditions, but only a few have been tested to produce FS-based pellets.

With the pilot plant, electricity consumption per metric ton of dry pellets produced was 36 to 57 kWh. This electricity is used for the grinding, mixing and pelletizing of the compost, but is not required for drying LFS (solar energy) or composting (manual labor). The energy cost therefore represents 15 to 25% of the pellet production cost while other utilities (mainly ammonium sulfate for enrichment and cassava starch) constitute some 40% of the total cost (Nikiema et al. 2013). The production cost in Ghana for pellets is about US\$ 0.2 per kilogram of pellets but could be lower in other countries (for example < US\$ 0.06 per kilogram of pellets in India).

The general minimal requirements to obtain 500 metric tons of pellets per year are presented in Table 19.

TABLE 19. GENERAL REQUIREMENTS FOR CO-COMPOST PELLET PRODUCTION.

MINIMUM REQUIREMENTS	ACCRA ^{1,2}	YAOUNDÉ ¹	BANGKOK ¹
Amount of public toilet waste per year (m ³)	5,110	-	-
Amount of household septic tank waste per year (m ³)	10,250	6,150	14,800
Sorted organic wastes (metric tons per year)	683		
Drying bed surface (m ²) ³	1,960		
Total composting surface (m ²)	1,120		
Pelletization room area (m ²)	100		
Energy consumption (kW) ⁴	10-20		

¹ These estimates are based on the sludge characteristics in Table 1. The amount of DFS generated is about 228 metric tons per year.

² The volume mixing ratio is 2:1, as discussed in Section 3.3.1.1.

³ Assuming a drying cycle of 14 days per batch and a 12-month drying period per year.

⁴ Sun-drying of pellets should be encouraged.

Source: Authors' calculations

CASE STUDY 2: EXTRUDER PELLETIZER; LADEPA PLANT

The Ladepa plant (Figure 24) is a patented technology which was jointly developed by the Durban Ethekwini Municipality (South Africa) and Particle Separation Systems Technologies Pty Ltd. The unit is composed of an extrusion section which extrudes the sludge in a form that is 'ideal' for drying while simultaneously separating the detritus, a substrate dehydration section (on an unsupported filter media) and a sanitization/drying section using medium wave infrared radiation (MIR) under negative pressure. The Ladepa plant is designed to process 0.5 to 20 metric tons per hour of raw FS from pit latrines (or dry FS) only.

FIGURE 24. LADEPA PILOT PLANT; PELLETS FROM RAW 'SOLID' FS IN SOUTH AFRICA.

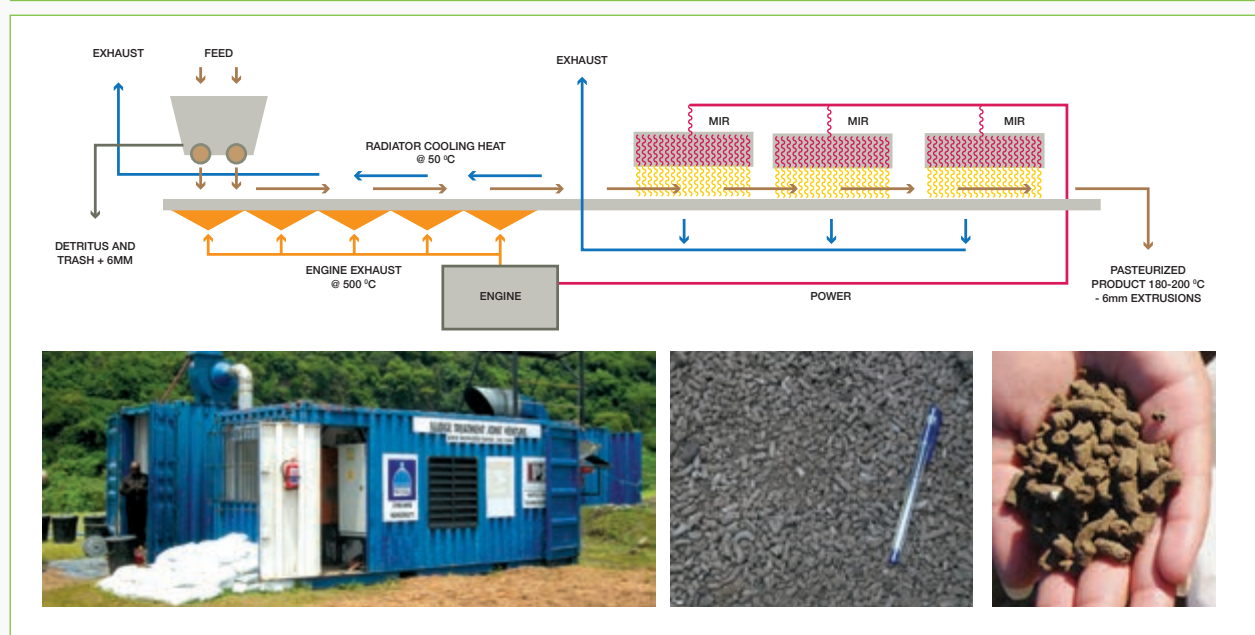

Sources: PSS (2013); Wilson and Harrison (2013); IWMI (2012).

Table 20 presents some key features, advantages and disadvantages of the Ladepa unit. One advantage of the Ladepa unit is that it could be mobile when sitting in a container. A pilot unit of this type is in use in Durban, South Africa. The cost of the machinery as well as its features is given in Table 21. Table 22 presents an estimation of the amounts of waste, space and energy required to produce 500 metric tons of pellets per year using this technology.

TABLE 20. FEATURES, ADVANTAGES AND DISADVANTAGES OF THE LADEPA UNIT.

KEY FEATURES	
<p>Characteristics of the feed and products</p> <ul style="list-style-type: none"> Feed (TS content: 20-35%): up to 1,000 kg h⁻¹ Detritus (15%): up to 150 kg h⁻¹ Final product: up to 300 kg h⁻¹ @ 80-90% solids <p>Characteristics of the machine</p> <ul style="list-style-type: none"> Belt width: 0.95 m; apertures: 300 microns Dryer width: 1.35 m; length: 11 m; height: 1.2 m Diameter of pellets: 6 mm 	<p>Operating conditions</p> <ul style="list-style-type: none"> Residence time: 8 minutes Product temperature: 180-220 °C Bagging rate: 20 bags of 15 kg h⁻¹ <p>Minimum energy requirements: 152 kW</p> <ul style="list-style-type: none"> Belt drive: 0.75 kW Screw drive: 1.50 kW Blower: 5.5 kW MIR: 144 kW <p>Evaporation rate: 3.6 l of water per kWh</p> <ul style="list-style-type: none"> Can use an internal combustion engine or a generator if mobility is required. <p>Fuel diesel consumption: 7-8 l h⁻¹</p>
<p>Advantages</p> <ul style="list-style-type: none"> Compact (low footprint) and neat Mobile, i.e. allows door-to-door operation Limited odor/nuisance generation Low processing time compared to composting or other methods 	<p>Disadvantages</p> <ul style="list-style-type: none"> High operating costs due to high energy demand (95% of the operation cost is to cover electricity/diesel supply). Only applicable to pit latrine FS O&M requires trained staff (1-2 people for operation) The pellets are not stabilized for use in agriculture

Sources: PSS (2013); Wilson and Harrison (2013).

This technology is expected to help address challenges linked with management and disposal of pit latrine sludge, a major health and environmental problem in many developing countries, including South Africa where the technology was developed. The end pellet product, even though not stabilized, is argued to be a nutrient-rich soil conditioner.

TABLE 21. ADDITIONAL CHARACTERISTICS OF THE LADEPA UNIT FOR DIFFERENT COMMUNITY SIZES.

DRYER SIZE/MODEL	NO. OF PEOPLE	FOOTPRINT (M ²)	RETAIL PRICE (US\$) ¹	MAXIMUM POWER REQUIRED (KW) ²	FEED (KG H ⁻¹) ³
SBD600 + 30	1,000	3	51,000	32.8	100
SBD600 + 45	1,500	3.5	51,100	47.8	200
SBD600 + 60	2,000	4	53,500	63.15	300
SBD600 + 75	2,500	4	53,900	78.15	400
SBD600 + 90	3,000	4.5	56,600	94.25	500

¹ Pricing is negotiable based on quantities. This pricing excludes VAT, power generators and containers or building.

² The machines do not run at maximum power capacity but instead at between 50 and 60% of it. So, for the SBD600+60 model, the actual power consumed per hour would be about 33 kW and not 63.15 kW exactly.

³ The output is 30-38% of the feed.

Source: Zanette (2013).

TABLE 22. GENERAL REQUIREMENTS FOR LADEPA PELLET PRODUCTION.

Minimum amount of excreta from dry toilets per year (metric tons) ¹	1,667
Sanitized DFS pellets produced (metric tons per year)	500
Required organic wastes (metric tons per year)	0
Footprint of the facility (m ²)	30
Energy requirement (kWh)	Up to 160

¹ The excreta must contain 20-35% of TS.

Source: Authors' calculations

5.3 Possible Additional Processes

Gamma irradiation is a process which normally causes atoms and molecules to become ionized or excited due to the gamma ray action, without temperature increase. This leads to the production of free radicals randomly causing the breakage or creation of new chemical bonds, including cross-linkages. In a sanitization context, they injure living tissue and deactivate key molecules that regulate vital cell processes (such as DNA, proteins). Consequently, organisms originally in the treated material become unable to grow or reproduce and eventually die (Nikiema et al. 2013). Gamma irradiation is not a technology easily available in most developing countries. In many cases, it is usually used for sanitizing medical equipment and food products which are normally sensitive to heating. The process has also been applied in treatment of municipal sludge or wastewater at a dose of 1.5 to 10 kilogray (kGy) (Shamma and Al-Adawi 2002; Gautam et al. 2005; de Souza et al. 2011). Key features, advantages and disadvantages of this technology are shown in Table 23.

In 2013, IWMI subjected DFS (obtained as described in Section 3.3.1.1) to 20 kGy of gamma rays for two days (conventional sanitization conditions within the facility) at the Radiation Technology Center of the Biotechnology and Nuclear Agricultural Centre in Ghana. The sanitized DFS was then pelletized (see Section 5.2 - Case study 1). The main advantage when applying this process is that there is

no reduction in mass, unlike with composting, and therefore more material can be recycled. However, the production cost of the technology remains highly prohibitive at about US\$ 0.68 per kilogram of pellets in Ghana (versus US\$ 0.2 for normal composting + pelletization). The product is also not stabilized and does not perform as well as composts following farm application.

The Japanese **Hosoya system** is designed to treat poultry and pig manure which is changed into an organic fertilizer using bacterial activity (fermentation). Typically, 12 to 14 m³ of manure with a solid content of approximately 25% are fed into the unit daily. The Hosoya Fermenting System takes about three weeks to convert this organic waste into natural fertilizer with a TS content of about 80 to 85%. The final product, whether packed or in bulk is recommended for growing fruit trees, vegetables and wine grapes. It can also be used for floriculture and horticulture (Georgakakis and Krintas 2000; Hosoya 2009a, 2009b). This technology has not been tested for FS, but given the similarities between pig manure and human waste, could perform well. Additional features, advantages and disadvantages of the technology are given in Table 23. Appendix 8.2 presents additional details on this technology.

The **Bioburn technology** allows recycling of moist biological residual materials by producing pellets for energy production through burning. It is designed for albuminous,

TABLE 23. KEY FEATURES, ADVANTAGES AND DISADVANTAGES OF SELECTED PROCESSES FOR FS RECYCLING.

	KEY FEATURES	ADVANTAGES	DISADVANTAGES
Gamma irradiation	<ul style="list-style-type: none"> Sanitizes FS Operating conditions: 1.5-20 kGy Residence time: up to 2 days No significant visual/textural change in the raw product 	<ul style="list-style-type: none"> Effective means of pathogen destruction No loss in nutrient and organic matter Low processing time 	<ul style="list-style-type: none"> High capital investment Requires skilled labor for operation Residual microbial regrowth has been reported Does not stabilize the DFS for agriculture
Hosoya fermenting system	<ul style="list-style-type: none"> Converts poultry and pig manure into organic fertilizer for agriculture, horticulture or floriculture Processing time is 3 weeks Dimensions: 80-100 m long; 4-6 m wide; 1-1.2 m deep Granules formed: 2-12 mm in size 	<ul style="list-style-type: none"> Compact, compared to composting and other pelletization Odor generation is controlled since the facility is covered The system is automated 	<ul style="list-style-type: none"> Initially designed for animal manure having a TS content of 25% principally High operating costs Equipment is not locally available O&M requires trained staff Product is not stabilized for use in agriculture
Bioburn	<ul style="list-style-type: none"> Converts moist organic waste into pellet fuel TS in feed: 65 to 75% Energy requirements: 0.145 kWh kg⁻¹ of pellets Flow rate: 100-120 kg h⁻¹ Space requirements; length: 14.6 m, width: 3.5 m, height: 3.5 m 	<ul style="list-style-type: none"> Strong pellets Versatile, i.e. applicable to various solid waste types No/low odor generation Level of complexity of the system can be adjusted to needs 	<ul style="list-style-type: none"> Full range of equipment is not locally available ^a The recipe must be optimized on a case-by-case basis
Carbonization	<ul style="list-style-type: none"> Converts organic waste into biochar Operating conditions High temperature (350-500°C) Limited O₂ Residence time: 30-90 minutes after the product is dried. 	<ul style="list-style-type: none"> Biochar may serve as adsorbent for air/wastewater treatment Provides an alternative for C sequestration Total removal of pathogens Facility can be placed in sensitive areas 	<ul style="list-style-type: none"> May require an external energy source Production requires expert knowledge Process leads to nutrient loss Pre-drying may be required

^a The pelletizing unit is not locally available, but all other parts are standard and locally available.

starchy, oleiferous, resinous or fiber-rich raw materials [e.g. horse dung, sludge, digestate, excrement or waste of plants and fruits]. Ashes from furnaces can be fed back to the soil as fertilizer. The bioburn pelletizing unit is composed of a particle cutter, a shredder, a pipe conveyor, silos (for mixing, drying, storing), a biomixer, a pelletizer as well as a system control (Appendix 8.1, Figure A8.2.1). The specificity of the pelletizer (Table 23) lies in the fact that the material is twisted instead of pressed. This allows processing of material with relative moisture of up to 35% and saves up to 50% of production energy. It also adds strength to the formed pellets.

To produce bioburn pellets, a principal biomass and additives are needed. The recipe has to be adapted to each feed material to ensure a dense, solid pellet and, if produced to burn, guarantees an output of typically 4.5 kW per kilogram of pellets. The typical cost of the fully automated unit amounts to approximately US\$ 160,000 to 220,000 excluding VAT. The costs and development efforts for any specific version of the pelletizing machine, adapted to local needs, have to be evaluated (for example without control/automation system or with fewer/simpler components).

Carbonization through pyrolysis, i.e. thermal decomposition under a limited supply of oxygen, can be used to produce FS biochar. Production of this is now considered a robust and simple way to sequester carbon (Wang et al. 2013). Biochar is composed mainly of aromatic forms of organic carbon which cannot readily be returned to the atmosphere as carbon dioxide even when added to the soil. Consequently, biochar has a longer lifecycle in soils than ordinary biomass (Sohi et al. 2010).

Figure 25 shows biochar produced in Ghana from FS. Key features, advantages and disadvantages of carbonization are given in Table 23.

FIGURE 25. BIOCHAR PRODUCED FROM FECAL SLUDGE IN ACCRA (GHANA).



Source: IWMI (2013).

As soil amendment, biochar is able to retain $\text{NH}_4^+\text{-N}$ (Steiner 2010) and also provide a habitat for soil micro-organisms capable of degrading more labile soil organic matter due to its high specific surface area of 400 to 800 $\text{m}^2 \text{g}^{-1}$ (Steiner 2010; Fischer and Glaser 2012). Birk et al. (2009) reported increased soil microbial biomass and change in composition of soil microbial community following biochar amendments. Biochar can also be used as a bulking agent during composting. Steiner et al. (2010) reported that composting poultry litter with 5-20% biochar, produced from pine chips, accelerated the decomposition rate and reduced ammonia concentration in emissions by up to 64%. The biochar also reduced TN loss by up to 52% by acting as an absorber of NH_3 and water-soluble NH_4^+ during the composting process. Biochar can also serve as a biosorbent material for the removal of various organic contaminants and heavy metals from air and wastewater (Beesley and Marmiroli 2011; Soldatkina et al. 2009; Malik 2003). In place of zeolite and silicate clay minerals such as sepiolite, biochar can be used for the removal of $\text{NH}_4\text{-N}$ from wastewater. The removal of NH_4^+ can be attributed to the microporous structure of the biochar (Hina 2013).

6 CONCLUSION

Recovery and recycling of organic matter has attracted some general interest lately. Previous research confirmed that such material improves soil structure, increases water-holding capacity, reduces pests and diseases and neutralizes soil toxins and heavy metals. Nutrients are also important to ensure high crop yields and achieve food security in the developing world. But in the case of fecal sludge, its high content in pathogens and sometimes water is a major limitation to the safe recycling of organic matter and nutrients. In the concept of waste recycling and reuse, it is expected that money generated from the recycled product would be used to cover in part or fully operation and maintenance costs of FS treatment facilities, which the municipalities often struggle to handle properly. Thus, on the one hand, large amounts of FS are not released into the environment without proper treatment. On the other hand, livelihoods of poor farmers can be improved through productivity increase resulting from availability of nutrients. Employment opportunities for youth, women or marginalized people are also created.

In the case of liquid FS, recovery starts with pre-treatment which allows for removal of foreign bodies such as plastics which are often found in it. Then the drying must begin, which can be achieved with a mechanical or non-mechanical unit.

For community-scale facilities in developing countries, non-mechanical processes are often recommended given the lower cost implied. One of these options includes use of settling ponds followed by drying beds which is recommended especially when the LFS is too diluted or is

not stabilized. Under the latter scenario, a longer residence time in the settling ponds must then be achieved, which allows the unstabilized sludge to be further stabilized, facilitating separation between solids and water. Another option is to directly use drying beds such as sand filters or planted drying beds. In the case of sand filters, it is essential to ensure that the ratio of stabilized to non-stabilized LFS feeding the bed is at least 2. The amount of dewatered or dried sludge (i.e. TS content of FS > 20%) obtained from sand filters is often higher than that resulting from planted drying beds. The reason is that the longer residence time in the latter (three to five years in principal) allows mineralization through biodegradation of trapped dewatered FS. But, planted drying beds generate biomass which can be recycled as well, e.g. as livestock feed.

When the treatment capacity must be high while available space is limited, which could be the case for some large urban areas, mechanical processes should be considered. The main constraint with such technologies is that they involve higher operating cost resulting from their high energy consumption, high input requirement (e.g. polymer is added because of the high content of organic matter in the FS) and/or higher complexity (requiring skilled staff for operation and maintenance) and so forth. Furthermore, dewatering with a mechanized process must often be preceded by a thickening process which will reduce volumes of material to process.

In many cases, the liquid effluent from the dewatering units must be treated further to meet the requirements for water reuse or discharge into the environment. Low-cost technologies such as waste stabilization ponds or wetlands could be used for the treatment. Other advanced processes (activated sludge, membranes, etc.) are also usable, but would involve higher operating costs. In the case of 'dry' FS, i.e. originating from dry toilets, recycling does not necessarily require a separate drying process. However, a bulking agent is often added to it to ensure reaching an adequate consistency for the following process to be successful.

The resulting dewatered or dry fecal solids must also be sanitized and ideally stabilized if designed for recycling in agriculture. Composting is the easiest technology which can achieve both simultaneously but it requires typically three months for processing. Although it is simple to implement, achieving proper co-composting of FS requires strict adherence to guidelines to ensure that a safe product is generated. For example, given the low carbon to nitrogen

ratio of the DFS, it is often necessary to undertake co-composting, i.e. composting FS mixed with another carbon-rich material such as organic market/municipal wastes. Long storage is sometimes preferred for planted drying beds and is achieved by stopping the feeding of the planted bed, e.g. one year before dewatered sludge is removed from the bed, which cancels the need for subsequent composting. Heating of the DFS, which requires a shorter processing time (typically of a few hours), is sufficient only for sanitization.

Composts and co-composts are bulky and therefore, in some instances, have a low market value. To alleviate this, the technology developed by IWMI promotes the use of enrichment as a technique to increase nutrient levels in the compost or co-compost and tailor its composition to the needs of soils on which it is applied and plants to be grown. Enrichment therefore lowers application rates, typically by 50% while converting composts and co-composts into organo-mineral fertilizer, best fitting nutrient demand by soils and plants. Consequently, the inorganic nutrients are available immediately after application of enriched compost/co-compost while the organic ones will gradually be mineralized. Further attempts to reduce bulkiness led to considering pelletization which reduces volumes by 20-50% depending on the type of enriched compost and co-compost. This process, by modifying the visual aspect of the FS based product, could also help in lowering negative perception barriers.

Some all-in-one technologies are available for FS drying, such as the Slamson Ghana Technology which has an operation cost of US\$ 1.3 to 1.7 per m³ of LFS in Accra, Ghana, or recycling, such as the Ladepa Technology applied to FS from dry toilets, which generates safe pellets that are not necessarily stabilized for use in agriculture. Other technologies effective for processing of other manure waste may also be adapted to fecal sludge. It is also possible to produce biochar, through carbonization, which can later be applied to soil as a carbon supplement or used as an energy source. On the other hand, there are other processes that yield energy (mainly through biogas combustion), but these are not covered in this document. However, they could constitute another avenue for resource recovery because energy may have, in some areas, more value than compost. So far, in Africa, it must be stressed that successful FS recycling cases are still not numerous. This is because institutional arrangements, funding or technical knowledge to sustain such initiatives are still deficient in many countries.

7 REFERENCES

- ACEE (Canadian Environmental Assessment Agency). 2009. *Environmental systems design*. Available at http://ocw.korea.edu/ocw/college-of-engineering/school-of-civil-environmental-and-architectural-engineering/data/ACEE434_Week12.pdf. Accessed June 2014.
- AIT (Asian Institute of Technology). 2012. *Final report: assessment of faecal sludge rheological properties*. Environmental Engineering Management, AIT, Pathumthani: AIT. 60p. Available at http://www.susana.org/_resources/documents/default/2-1661-fs-final-report31-01-12.pdf. Accessed June 2014.
- Awuah, E.; Oppong-Peprah, M.; Lubberding, H.J.; Gijzen, H.J. 2004. Comparative performance studies of water lettuce, duckweed, and algal-based stabilization ponds using low-strength sewage. *Journal of Toxicology and Environmental Health Part A*, 67: 1727-1739.
- Barro, R. 2012. Contribution à la mise en place d'une station de traitement des matières de vidanges par lits de séchage plantés de *Echinochloa pyramidalis* à Ouagadougou. Master thesis. Available at http://documentation.2ie-edu.org/cdi2ie/opac_css/doc_num.php?explnum_id=125. Accessed June 2014.
- Beesley, L.; Marmiroli, M. 2011. The immobilization and retention of soluble arsenic, cadmium and zinc by biochar. *Environmental Pollution* 159: 474-480.
- Bernal, M.P.; Paredes, C.; Sanchez-Monedero, M.A.; Cegarra, J. 1998. Maturity and stability parameters of compost prepared with a wide range of organic wastes. *Bioresource Technology* 63: 91-99.
- Bioburn. 2014. Personal communication. info@bioburn.ch or www.bioburn.ch
- Birk, J.J.; Steiner, C.; Teixeira, W.C.; Zech, W.; Glaser, B. 2009. Microbial response to charcoal amendments and fertilization of a highly weathered tropical soil. In *Amazonian dark earths*, ed. Woods, W.I.; Teixeira, W.G.; Lehmann, J.; Steiner, C.; Winkler Prins, A.M.G.A.; Rebellato, L., 309-324. Wim Sombroek's Vision. Berlin: Springer.
- Bratby, J. 2006. *Coagulation and flocculation in water and wastewater treatment* (2nd ed.). London: IWA Publishing.
- Chabrier, J.P. 1999. Thermal drying – microbiological quality of dried sludge. In *Workshop on problems around sludge*, ed. Langenkamp, H., 49-57. Sresa.
- Cofie, O.; Adamtey, N. 2009. *Nutrient recovery from human excreta for urban and peri-urban agriculture*. WEDC Conference, Addis Ababa, April 15, 2009. Available at <http://publications.iwmi.org/pdf/H042722.pdf>. Accessed June 2014.
- Cofie, O.; Agbottah, S.; Strauss, M.; Esseku, H.; Montangero, A.; Awuah, E.; Koné, D. 2006. Solid-liquid separation of faecal sludge using drying beds in Ghana: implications for nutrient recycling in urban agriculture. *Water Research* 40(1): 75-82.
- Cofie, O.; Koné, D.; Rothenberger, S.; Moser, D.; Zubruegg, C. 2009. Co-composting of faecal sludge and organic solid waste for agriculture: Process dynamics. *Water Research* 43(18):4665-4675.
- Cofie, O.; Van Rooijen, D.; Nikiema, J. 2014. Challenges and opportunities for recycling excreta for peri-urban agriculture in urbanising countries. *Water Science and Technology Library*, Volume 71.
- Csiba, A.; Fenyvesi, L. 2014. *Facilities of poultry manure processing and utilization with environmental technologies*. Available at http://cigr.ageng2012.org/images/fotosg/tabla_137_C2228.pdf. Accessed June 2014.
- De Souza, G.S.; Rodrigues, L.A.; de Oliveira, W.J.; Chernicharo, C.A.; Guinaraes, M.P.; Massar, C.L.; Grossi, P.A. 2011. Disinfection of domestic effluents by gamma radiation: effects on the inactivation of *Ascaris lumbricoides* eggs. *Water Research* 45(7): 5523-5528.
- Dodane, P.-H.; Bassan, M. 2014. Settling-thickening tanks. In *Faecal sludge management: system approach for implementation and operation*, Chapter 6, ed. Strande, L.; Ronteltap, M.; Brdjanovic, D., 123-139. London: IWA Publishing. Available at http://www.eawag.ch/forschung/sandec/publikationen/ewm/dl/fsm_book.pdf Accessed July 2014.
- Dodane, P.H.; Mbéguéré, M.; Kengne, I.M.; Strande-Gaulke, L. 2011. Planted drying beds for faecal sludge treatment: lessons learned through scaling up in Dakar, Senegal. *Sandec News* 12. Available at http://www.eawag.ch/forschung/sandec/publikationen/ewm/dl/sandecnews/SN12_reedbeds.pdf Accessed July 2014.
- Dodane, P.H.; Ronteltap M. 2014. Unplanted drying beds. In *Faecal sludge management - systems approach for implementation and operation*, Chapter 7. ed. Strande, L.; Ronteltap, M.; Brdjanovic, D., 123-139. London: IWA Publishing. Available at http://www.eawag.ch/forschung/sandec/publikationen/ewm/dl/fsm_7.pdf
- DMTC (Development Management and Training Consultants). 2011. *Market study on demand for use of wastewater, excreta and faecal sludge and other related by-products*; Final Report 2011. Uganda: NETWAS. 48p.
- EAWAG – SANDEC. 2006. *Traitement des boues de vidange; Performances et challenges*. Symposium International sur la Politique de Gestion des Boues de vidange (GBV), Dakar, Sénégal. Available at http://siteresources.worldbank.org/EXTWAT/Resources/4602122-1215104787836/FSM_Traitement_Boues_Vidange.pdf. Accessed June 2014.
- EPA (Environmental Protection Agency – USA). 2000a. *Biosolids - technology fact sheet*; centrifuge thickening and dewatering. Available at <http://nepis.epa.gov/Adobe/PDF/901U0S00.PDF>. Accessed June 2014.
- EPA. 2000b. *Biosolids - technology fact sheet*; belt filter press. Available at http://water.epa.gov/scitech/wastetech/upload/2002_06_28_mtb_belt_filter.pdf. Accessed June 2014.
- EPA. 2000c. *Biosolids - technology fact sheet*; recessed-plate filter press. Available at http://water.epa.gov/scitech/wastetech/upload/2002_06_28_mtb_recessed-plate.pdf. Accessed June 2014.
- EPA. 2003. *Biosolids - technology fact sheet*; gravity thickening. Available at http://water.epa.gov/scitech/wastetech/upload/2003_09_30_mtb_final_gravitythickening.pdf. Accessed June 2014.
- EPA. 2006. *Biosolids - technology fact sheet*; heat drying. Available at http://water.epa.gov/scitech/wastetech/upload/2006_10_16_mtb_heat-drying.pdf. Accessed June 2014.
- Fischer, D.; Glaser, B. 2012. Synergisms between compost and biochar for sustainable soil amelioration. *Management of Organic Waste* 10: 167-198. Available at <http://cdn.intechopen.com/pdfs/27163.pdf>. Accessed July 2014.
- Flaga, A. 2007. Sludge drying. In *Integration and optimisation of urban sanitation systems*. ed. Plaza, L., TRITA-LWR.REPORT 3018, Report No 13, 71-80. Available at <http://www2.lwr.kth.se/Forskningsprojekt/Polishproject/rep13/Flagasludgedrying73.pdf>. Accessed July 2014.
- FSMS (Faecal Sludge Management Seminar) 2011. What Happens When the Pit is Full? - Developments in on-site Faecal Sludge Management (FSM). Durban, South Africa. Available at http://www.ecosanres.org/pdf_files/WhatHappensWhenThePitsFullFSMSeminarReportSouthAfricaNodeMarch2011.pdf. Accessed July 2014.
- Fuchs, J.G. 2002. Practical use of quality compost for plant health and vitality improvement. In *Microbiology of composting*, ed. Insam, H.; Riddech, N.; Klammer, S., 435-444. Heidelberg: Springer Verlag.
- Gautam, S.; Shah, M.R.; Sabharwal, S.; Sharma, A. 2005. Gamma irradiation of municipal sludge for safe disposal and agricultural use. *Water Environ. Res.* 77(5): 472-479.
- Georgakakis, D.; Krintas, T. 2000. Optimal use of the Hosoya system in composting poultry manure. *Bioresource Technology* 72: 227-233.
- Gonçalves, R.F.; Luduvic, M.; von Sperling, M. 2007. *Sludge thickening and dewatering*. IN. Sludge treatment and disposal: Biological Wastewater Treatment Series (Vol. XI). Cleveron, C.V.; von Sperling, M.; Fernandes, F. Editors, IWA (International Water Association) publishers. Available at http://www.sswm.info/sites/default/files/reference_attachments/ANDREOLI%20et%20al%202007%20Sludge%20Treatment%20and%20Disposal.pdf. Accessed in July 2014.
- Hara, M. 2001. Fertilizer pellets made from composted livestock manure. Extension Bulletin - Food Fertilizer Technology Center of Asia and Pacific Regions 506: 1-12.
- Heinss, U.; Larmie, S.A.; Strauss, M. 1998. *Solids separation and pond systems for the treatment of faecal sludges in the tropics (2nd ed.)*. SANDEC Report No. 05/98. Available at http://www.sswm.info/sites/default/files/reference_attachments/HEINSS%201998%20Solids%20Separation%20and%20Pond%20Systems%20For%20the%20Treatment%20of%20Faecal%20Sludges%20In%20the%20Tropics.pdf. Accessed June 2014.

- Hina, K. 2013. *Application of biochar to wastewater treatment*. PhD dissertation, Massey University. Available at http://muir.massey.ac.nz/bitstream/handle/10179/4288/02_whole.pdf?sequence=1. Accessed July 2014.
- Hoffmann, H.; Platzer, C.; Winker, M.; Muench, E.V. 2011. *Technology review of constructed wetlands; Subsurface flow constructed wetlands for greywater and domestic wastewater treatment*. Eschborn: Deutsche Gesellschaft fuer Internationale Zusammenarbeit (GIZ) GmbH.
- HOSOYA. 2009a. Poultry manure fermenting system. Video. Available at <http://www.k-hosoya.co.jp/en/products/products3.html>. Accessed June 2014.
- HOSOYA. 2009b. Poultry Manure Fermenting System. Video. Available at <http://www.youtube.com/watch?v=8tAsQWTAHao&feature=channel&list=UL>. Accessed June 2014.
- Huber Technology. 2013. Use of Heat from Biogas Cogeneration for Sludge Drying. Available at <http://www.huber.de/huber-report/ablage-berichte/sludge-treatment/use-of-heat-from-biogas-cogeneration-for-sludge-drying.html>. Accessed June 2014.
- IWK (Indah Water Konsortium). 2012. Workshop on innovations for scaling up to citywide sanitation. October 16-17, Ahmedabad. Available at [http://www.pas.org.in/Portal/document/ResourcesFiles/WorkshopPDFs/Citywide%20Sanitation%20Workshop/12_Overview%20of%20FSM%20in%20Malaysia%20\(A%20Hartini%20\).pdf](http://www.pas.org.in/Portal/document/ResourcesFiles/WorkshopPDFs/Citywide%20Sanitation%20Workshop/12_Overview%20of%20FSM%20in%20Malaysia%20(A%20Hartini%20).pdf). Accessed June 2014.
- Kayombo, S.; Mbwette, T.S.A.; Katima, J.H.Y.; Ladegaard, N.; Jorgensen, S.E. 2004. *Waste stabilization ponds and constructed wetlands design manual*. Dar es Salaam/Copenhagen: United Nations Environmental Program - International Environmental Technology Centre (UNEP-IETC) and Danish International Development Agency Danida). Available at http://www.sswm.info/sites/default/files/reference_attachments/KAYOMBO%20et%20al%202004%20Waste%20Stabilization%20Ponds%20and%20Constructed%20Wetlands%20Design%20Manual_0.pdf. Accessed July 2014
- Keller, U. 1983. Technology of sewage sludge hygienization. *Zentralbl. Bakteriol. Mikrobiol. Hyg.* 178: 111-41.
- Kengne, I.M.; Dodane, P.-H.; Akoa, A.; Kone, D. 2009. Vertical-flow constructed wetlands as sustainable sanitation approach for faecal sludge dewatering in developing countries. *Desalination* 248: 291-297.
- Kengne, I.M.; Kouassi, D.; Doulaye K.; Strande, L. 2012. Productive treatment of faecal sludge: from waste to fodder and profits. Evidence for Policy Series, regional edition West Africa, No. 2, ed. Bassirou, B. Abidjan, Côte d'Ivoire: NCCR North-South. Available at http://www.susana.org/docs_ccbk/susana_download/2-1634-regionalpolicybrief02wafsanitationtechnologysdb.pdf. Accessed July 2014.
- Kengne, I.M.; Tilley, E. 2014. Planted drying beds. In *Faecal sludge management: system approach for implementation and operation*, Chapter 8., ed. Strande, L.; Ronteltap, M.; Brdjanovic, D., 155-174. London: IWA Publishing. Available at http://www.eawag.ch/forschung/sandec/publikationen/ewm/dl/fsm_book.pdf. Accessed July 2014
- Kilian, R.; Shimada T. 2009. *Madison metropolitan sewerage district solids handling facilities plan: Technical memorandum No. 8: Sludge thickening systems evaluation*. Carollo Engineers. 11pp. Available at <http://www.madsewer.org/Portals/0/Planning/FacilityPlans/SolidsHandlingPlan/Appendix%20K.pdf> Accessed June 2014.
- Koné, D. 2002. *Epuración des eaux usées par lagunage à microphytes et à macrophytes en Afrique de l'Ouest et du Centre: état des lieux, performances épuratoires et critères de dimensionnement*. Thesis number 2653, École Polytechnique Fédérale de Lausanne. Available at http://www.sswm.info/sites/default/files/reference_attachments/KONE%202002%20Epuración%20des%20eaux%20usees%20par%20Lagunage%20a%20Microphytes%20et%20a%20Macrophytes%20en%20Afrique%20de%20l'Ouest%20et%20du%20Centre.pdf
- Koné, D.; Cofie, O.; Nelson, K. 2010. Low cost options for pathogen reduction and nutrient recovery from faecal sludge. In *Wastewater irrigation and health: Assessing and mitigation risks in low-income countries*, ed. Drechsel, P.; Scott, C.A.; Raschid-Sally, L.; Redwood, M.; Bahri, A., 171-188. UK: Earthscan-IDRC-IWMI.
- Koné, D.; Cofie, O.; Zurbrügg, C.; Gallizzi, K.; Moser, D.; Drescher, S.; Strauss, M. 2007. Helminth eggs inactivation efficiency by faecal sludge dewatering and co-composting in tropical climates. *Water Research* 41(19): 4397-4402.
- Koné, D.; Strauss, M. 2004. Low-cost options for treating faecal sludges (FS) in developing countries – challenges and performance. Paper presented to the 9th International IWA Specialist Group Conference on Wetlands Systems for Water Pollution Control and to the 6th International IWA Specialist Group Conference on Waste Stabilisation Ponds, Avignon, France, 27 September to 1 October 2004.
- Kuffour, A.R.; Awuah, E.; Anyemedu, F.O.K.; Strauss, M.; Koné, D.; Cofie, O. 2009. Effect of using different particle sizes of sand as filter media for dewatering faecal sludge. *Desalination* 248(1-3): 308-314.
- Kuffour, A.R.; Awuah, E.; Sarpong, D.; Anyemedu, F.O.K.; Koné, D. 2013. Effects of different solid loading rates of faecal sludge on the dewatering performance of unplanted filter bed. *Civil and Environmental Research*, 3(4): 39-48.
- Kvarnström, E.; Joep ,V.; Mats, N.; Vishwanath, S.; Shubha, R.; Karan S. 2012. *The business of the honey-suckers in Bengaluru (India): the potentials and limitations of commercial faecal sludge recycling – an explorative study*. Occasional Paper 48 (online). The Hague: IRC (International Water and Sanitation Centre). Available at <http://www.hydratellife.org/wp-content/uploads/2012/12/The-Business-of-the-Honey-Suckers-in-Bengaluru-India-The-Potentials-and-Limitations-of-Commercial-Faecal-Sludge-Recycling.pdf>. Accessed June 2014.
- Libhaber, M.; Orozco-Jaramillo, A. 2013. *Sustainable treatment of municipal wastewater*. Water21, October 2013 (15.5) IWA Publishing, pp. 25-28.
- Libra, J.A.; Ro, K.S.; Kammann, C.; Funke, A.; Berge, N.D.; Neubauer, Y.; Titirici, M.M.; Fühner, C.; Bens, O.; Kern, J.; Emmerich, K.H. 2011. Hydrothermal carbonization of biomass residuals: a comparative review of the chemistry, processes and applications of wet and dry pyrolysis. *Biofuels*, 2: 71-106. Available at http://www.karlheinzemmerich.de/Dokumente/HTC_Review_Biofuels_2011.pdf. Accessed July 2014.
- Malik, P.K. 2003. Use of activated carbons prepared from sawdust and rice husk for adsorption of acid dyes: a case study of Acid Yellow 36. *Dyes and Pigments* 56: 239-249.
- Mara, D.D.; Alabaster, G.P.; Pearson, H.W.; Mills, S.W. 1992. *Waste stabilization ponds: a design manual for Eastern Africa*. Leeds: Lagoon Technology International.
- Masi, F. 2012. *Constructed wetlands in warm and hot climate countries: new developments*. 1st International WATERBIOTECH Conference, October 9-11, Cairo, Egypt.
- Metcalf and Eddy Inc. 2003. *Wastewater engineering: treatment and reuse*. Ed. Tchobanoglous, G.; Burton, F.L.; Stensel, H.D. New York: McGraw-Hill.
- Montangero, A.; Strauss, M. 2004. *Faecal sludge treatment*. Duebendorf: Swiss Federal Institute of Aquatic Science (EAWAG), Department of Water and Sanitation in Developing Countries (SANDEC).
- Morel, A.; Diener, S. 2006. *Greywater Management in low and middle-income countries, Review of different treatment systems for households or neighbourhoods*. SANDEC Report No. 14/06. Duebendorf: Swiss Federal Institute of Aquatic Science (EAWAG), Department of Water and Sanitation in Developing Countries (SANDEC).
- Mthembu, M.S.; Odinga, C.A.; Swalaha, F.M.; Bux, F. 2013. Constructed wetland: A future alternative wastewater treatment technology. *African Journal of Biotechnology* 12(29): 4542-4553.
- Nartey, E. 2013. *Faecal sludge reuse in urban and peri-urban crop production: Case studies of Sekondi-Takoradi and Kwaebibrim district*. MPhil dissertation. University of Ghana.
- National Biosolids Partnership. 2005. *National manual of good practice for biosolids*. Available at: www.wef.org/WorkArea/DownloadAsset.aspx?id=7764. Accessed June 2014.
- Nelson, K.L.; Cisneros, B.J.; Tchobanoglous, G.; Darby, J.L. 2004. Sludge accumulation, characteristics, and pathogen inactivation in four primary waste stabilization ponds in central Mexico. *Water Research* 38(1): 111-127pp.

- Nikiema, J.; Cofie, O.; Asante-Bekoe, B.; Otoo, M.; Adamtey N. 2014. Potential of locally available products for use as binder in producing fecal compost pellets in Ghana. *Environmental Progress & Sustainable Energy* 33(2): 504-511pp.
- Nikiema, J.; Cofie, O.; Impraim, R.; Adamtey, N. 2013. Processing of fecal sludge to fertilizer pellets using a low-cost technology in Ghana. *Environment and Pollution* 2(4): 70-87pp.
- Niwagaba, C.B.; Mbéguéré, M.; Strande, L. 2014. Faecal sludge quantification, characterisation and treatment objectives. In *Faecal sludge management: system approach for implementation and operation*, Chapter 2. ed. Strande, L.; Ronteltap, M.; Brdjanovic, D, 19-43. London: IWA Publishing. Available at http://www.eawag.ch/forschung/sandec/publikationen/ewm/dl/fsm_book.pdf. Accessed July 2014.
- Poppendieck, D. 2008. Photo taken at the Arcata Wastewater Treatment Plant (California, USA) on March 6. Available at <http://www.humboldt.edu/arcatamarsh/images/arcata6984small.JPG>. Reproduced with permission from author.
- PSS (Particle Separation Systems Technologies Pty Ltd.). 2013. The Ladepa process. Brochure, 4pp.
- Radford, J.T.; Sugden, S. 2014. Measurement of faecal sludge in-situ shear strength and density. Short communication. *Water SA* 40(1): 183-187.
- Rose, D.G. 1999. *Community-based technologies for domestic wastewater treatment and reuse – options for urban agriculture*. Cities Feeding People (CFP) Report Series 27. Ottawa: International Development Research Center Canada. Available at http://www.sswm.info/sites/default/files/reference_attachments/Rose%201999%20Community-Based%20Technologies%20for%20Domestic%20Wastewater%20Treatment%20and%20Reuse-%20Options%20for%20Urban%20agriculture.pdf. Accessed July 2014.
- Shamma, M.; Al-Adawi, M. 2002. The morphological changes of *Ascaris lumbricoides* ova in sewage sludge water treated by gamma irradiation. *Radiation Physics and Chemistry* 65(3): 277-279.
- Slamson. 2014. Personal communication.
- Sobsey, M.D. 2006. *Excreta and household wastewaters – introduction*. Available at http://www.unc.edu/courses/2007spring/envr/890/003/lectures/0213_lecture7_excreta.ppt. Accessed June 2014.
- Soldatkina, L.M.; Sagaidak, E.V.; Menchuk, V.V. 2009. Adsorption of cationic dyes from aqueous solutions on sunflower husk. *Journal of Water Chemistry and Technology* 31(4): 238-243pp.
- Sohi, S.; Krull, E.; Lopez-Capel, E.; Bol, R. 2010. A review of biochar and its use and function in soil. *Advances in Agronomy*, 105: 47-82pp.
- Steiner, C.; Das, K.C.; Melear, N.; Lakly, D. 2010. Reduced nitrogen loss during poultry litter composting using biochar. *Journal of Environmental Quality* 39: 1236-1242pp.
- SSWM (Sustainable Sanitation and Water Management). 2013a. *Mechanical dewatering*. Available at <http://www.sswm.info/category/implementation-tools/wastewater-treatment/hardware/sludge-treatment/mechanical-dewatering>. Accessed June 2014.
- SSWM. 2013b. *Waste stabilization ponds*. Available at <http://www.sswm.info/category/implementation-tools/wastewater-treatment/hardware/semi-centralised-wastewater-treatments/w>. Accessed June 2014.
- SSWM. 2013c. *Constructed wetlands*. Available at <http://www.sswm.info/content/horizontal-flow-constructed-wetland>. Accessed June 2014.
- SSWM. 2013d. *Drying beds*. Available at <http://www.sswm.info/category/implementation-tools/wastewater-treatment/hardware/sludge-treatment/drying-beds>. Accessed June 2014.
- Strauss, M.; Larmie, S.A.; Heinss, U. 1997. Treatment of sludges from on-site sanitation - low-cost options. *Water Science and Technology* 6: 129-136.
- Tilley, E.; Luethi, C.; Morel, A.; Zurbrugg, C.; Schertenleib, R. 2008. *Compendium of sanitation systems and technologies*. Duebendorf, Switzerland: Swiss Federal Institute of Aquatic Science and Technology.
- Tiquia, S.M.; Tam, N.F.Y. 1998. Elimination of phytotoxicity during co-composting of spent pig-manure sawdust litter and pig sludge. *Bioresource Technology* 65: 43-49.
- Turovskiy, I.S.; Mathai, P.K. 2006. *Wastewater sludge processing*. John Wiley & Sons. 250 pp.
- Uggetti, E.; Ferrer, I.; Llorens, E.; García, J. 2010. Sludge treatment wetlands: A review on the state of the art. *Bioresource Technology* 101(9): 2905-2912.
- Van Haandel, A.C.; Lettinga, G. 1994. *Anaerobic sewage treatment: a practical guide for regions with a hot climate*. John Wiley and Sons. 222 pp.
- Vinnerås, B. 2007. Comparison of composting, storage and urea treatment for sanitising of faecal matter and manure. *Bioresource Technology* 98: 3317-3321.
- von Sperling, M.; Chernicharo, C.A.D.L. 2005. *Biological wastewater treatment in warm climate regions* (Vol. I). IWA publisher. <http://www.iwawaterwiki.org/xwiki/bin/download/Articles/DevelopingCountriesTitlesfromIWAPublishingFreetoDownload/Biological1.pdf>. Accessed in June 2014.
- Wakeman, R.J. 2007. Separation technologies for sludge dewatering. *Journal of Hazardous Materials* 144(3): 614-619.
- Wang, L.K.; Li, Y.; Shammass, N.K.; Sakellaropoulos, G.P. 2007. Drying beds. In *Handbook of environmental engineering, Vol. 6: Biosolids treatment processes*, ed. Wang, L.K.; Shammass, N.K.; Hung, Y.-T.; Totawa, N.J. The Humana Press Inc.
- Wang, S.; Zhao, X.; Xing, G.; Yang, L. 2013. Large-scale biochar production from crop residue: A new idea and the biogas-energy pyrolysis system. *BioResource* 8(1): 8-11.
- Waterbiotech. 2013. *Guideline for the implementation process for water treatment biotechnologies*. Project title: *Biotechnology for Africa's sustainable water supply*. Deliverable D4.11. 105 pp.
- Weissenbacher, N.; Langergraber, G.; Figoli, A.; Nikiema, J.; Moulin, P.; Perreira, F.; Schories, G. 2014. *Cost considerations for the implementation of innovative biotechnologies for wastewater treatment in Africa*. 2nd International WATERBIOTECH Conference, Marrakech, 8-10, January 2014.
- WHO (World Health Organization). 2006. *WHO guidelines for the safe use of wastewater, excreta and greywater: Volume 3: Wastewater and excreta use in aquaculture*. WHO. 158 pp.
- Wilson, D.; Harrison, J. 2013. *Towards a sustainable pit latrine management strategy through LaDePa technology*. Poster.
- WSA (Water and Sanitation for Africa) – Togo. 2009. *Installation et comparaison de modèles de technologie de traitement des boues de vidange et des eaux usées dans les villes de Kara (Togo) et Natitingou (Bénin): Analyse de base de la situation et préparation d'un document détaillé du projet de démonstration pour la Ville de Kara*. Programme des Nations Unies pour l'Environnement, Projet n°53885. 100 pp.
- Zanette, M. 2013. Personal communication. <http://www.parsep.co.za/>

8 APPENDIXES

8.1 Figures of Selected Technologies

FIGURE A8.1.1. FLOW DIAGRAM OF A RECTANGULAR FLOTATION THICKENER.

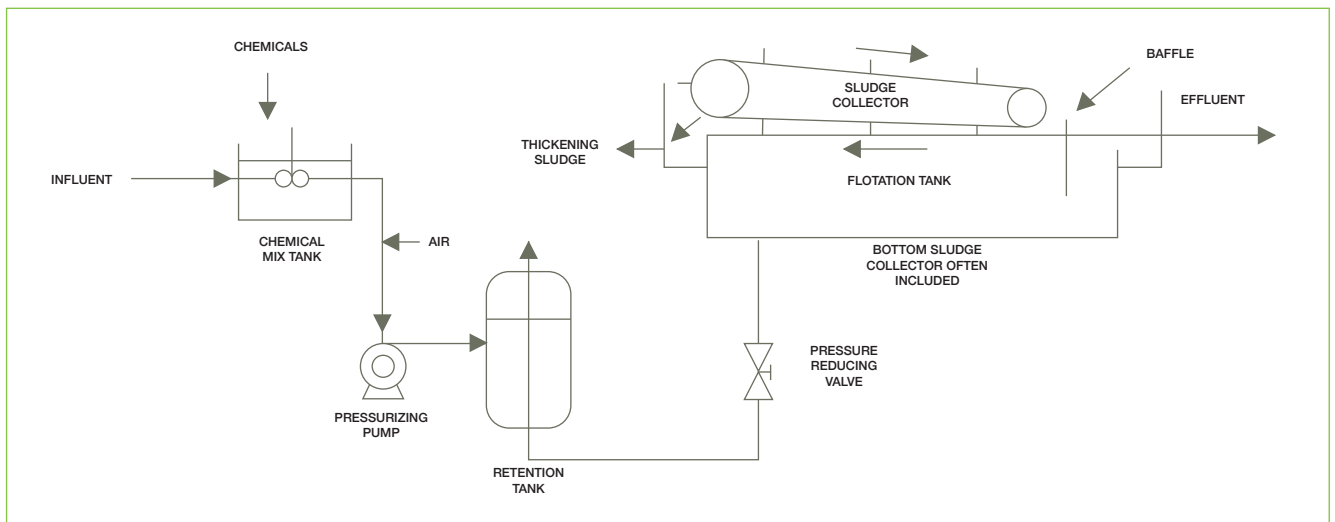

Source: Wang et al. (2007).

FIGURE A8.1.2. ROTARY DRUM THICKENING SYSTEM.⁶

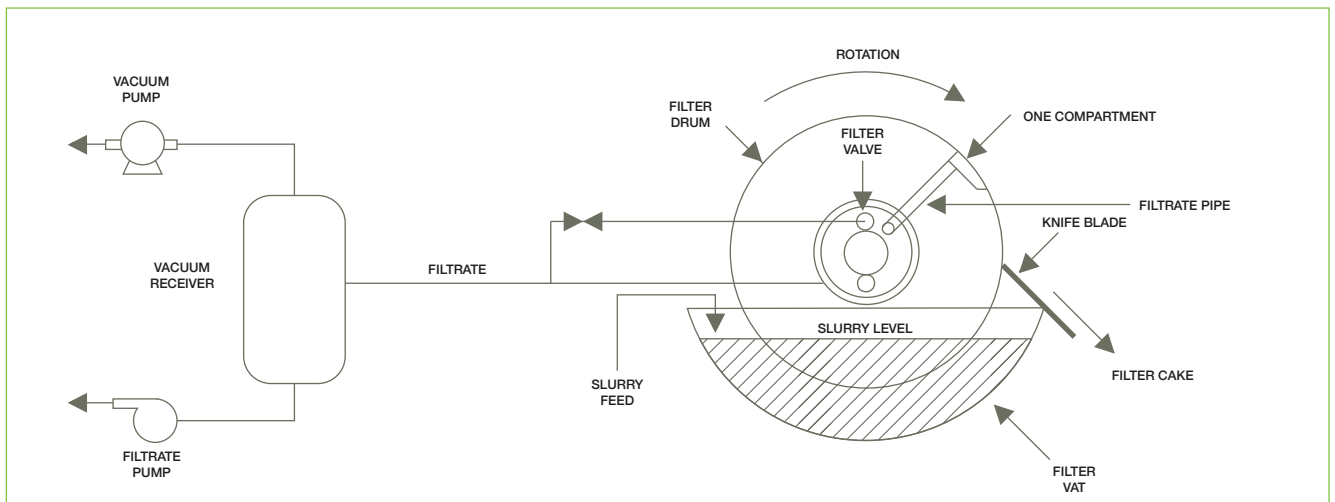
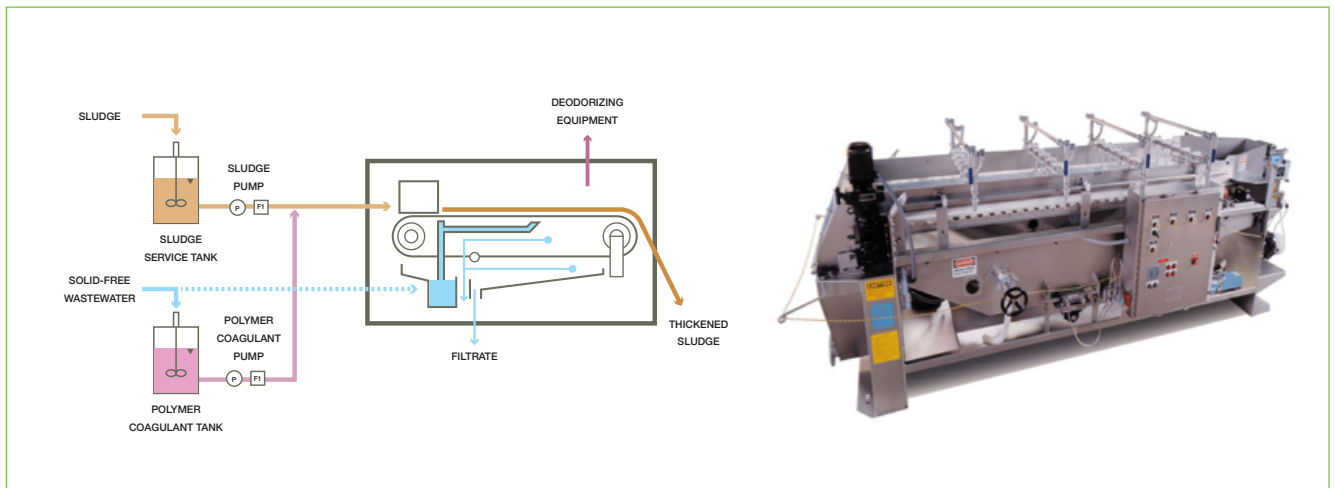

FIGURE A8.1.3. GRAVITY BELT THICKENING SYSTEM.⁷



Source: "Reproduced from <http://www.komline.com/images/G25.jpg> with permission from Komline-Sanderson"

⁶ <http://www.globalspec.com/ImageRepository/LearnMore/Rotary%20drum%20diagram.png>

⁷ Adapted from http://nett21.gec.jp/water/data/water_18-10.html / <http://www.komline.com/images/G25.jpg>

FIGURE A8.1.4. FILTER BELT PRESS FOR SLUDGE.⁸

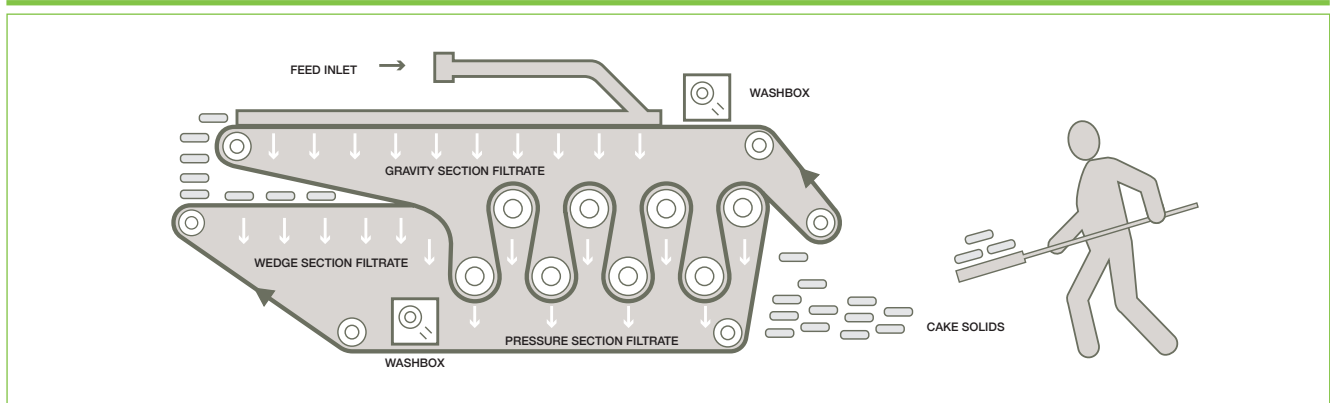

FIGURE A8.1.5. THE BIOBURN PLANT.



Source: Bioburn (2014).

8.2 Case Study: Granulator; The Hosoya Fermenting System

The system (an oval-shaped concrete channel) consists of a series of rotating metallic knives or forks with which the manure is completely turned, aerated and gradually pushed to the exit of the installation (Figure 32). It is placed under a closed greenhouse-type shelter with a metallic skeleton to favor high temperatures (typically 60°C) in the facility. The final product of the Hosoya system is granulated material, 2-12 mm in size, formed as a result of the turning in the channel of the initially muddy-textured raw material.

FIGURE A8.2.1. THE HOSOYA SYSTEM APPLIED IN GREECE AND THE UNITED STATES.



Continuous fermentation system 'F-1' for fermenting and drying

Advantages: Easy moisture adjustment, good fermentation, easy automation, less maintenance, fine product consistency. It changes manure to granule fertilizer, so there is no need for a supplementary pelletization machine.

⁸ <http://www.4enveng.com/userfiles/image/belt-press-2.jpg>; <http://image.made-in-china.com/43f34j00iCmEYzgdHjuR/Belt-Filter-Press-Excrement-Sludge-400-.jpg>



The F-2 system is used for final drying to produce premium quality fertilizer. The tank is equipped with an aeration system in the bottom and both agitating and aeration hasten the drying process.

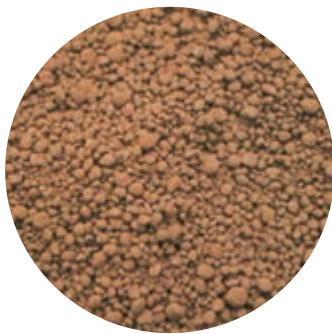

Final product from the unit

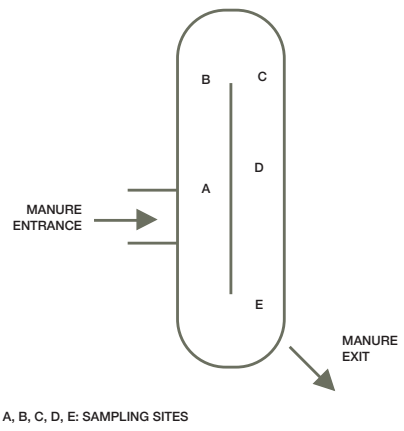

Sources: Csiba and Fenyvesi (2014); Georgakakis and Krintas (2000).



RESEARCH PROGRAM ON
Water, Land and
Ecosystems



Photo: Mary Lydecker

CGIAR Research Program on Water, Land and Ecosystems

The **CGIAR Research Program on Water, Land and Ecosystems (WLE)** combines the resources of 11 CGIAR centers, the Food and Agriculture Organization of the United Nations (FAO) and numerous national, regional and international partners to provide an integrated approach to natural resource management research. WLE promotes a new approach to sustainable intensification in which a healthy functioning ecosystem is seen as a prerequisite to agricultural development, resilience of food systems and human well-being. This program is led by the International Water Management Institute (IWMI) and is supported by CGIAR, a global research partnership for a food-secure future.

Resource Recovery and Reuse (RRR) is a sub-program of WLE dedicated to applied research on the safe recovery of water, nutrients and energy from domestic and agro-industrial waste streams. This sub-program aims to create impact through different lines of action research, including (i) developing and testing scalable RRR business models, (ii) assessing and mitigating risks from RRR for public health and the environment, (iii) supporting public and private entities with innovative approaches for the safe reuse of wastewater and organic waste, and (iv) improving rural-urban linkages and resource allocations while minimizing the negative urban footprint on the peri-urban environment. This sub-program works closely with the World Health Organization (WHO), Food and Agriculture Organization of the United Nations (FAO), United Nations Environment Programme (UNEP), United Nations University (UNU), and many national and international partners across the globe. The RRR series of documents present summaries and reviews of the sub-program's research and resulting application guidelines, targeting development experts and others in the research for development continuum.

CGIAR Research Program on Water, Land and Ecosystems
International Water Management Institute (IWMI)
127 Sunil Mawatha, Pelawatta
Battaramulla, Sri Lanka
Email: wle@cgiar.org
Website: wle.cgiar.org
Agriculture and Ecosystems Blog: wle.cgiar.org/blogs

ISSN 2478-0510
e-ISSN 2478-0529
ISBN 978-92-9090-804-3

IN PARTNERSHIP WITH:

