

Guidelines for Developers

VOLUME 1 **Sewerage Policy for New Developments**

PART C **Sewerage Catchment Planning Manual**

Table of Contents

Section 1 Introduction To The Manual

- 1.1 Purpose
- 1.2 Objectives
- 1.3 Governing Principles
- 1.4 Content
- 1.5 Structure

Section 2 Basic Principles Governing The Conduct Of Sewerage Catchment Planning

- 2.1 Introduction
- 2.2 Basic Objectives and Needs
- 2.3 Community Wide Approach
- 2.4 General Policies Governing Sewerage Management
- 2.5 General Procedures for Evolving Sewerage Catchment Plans
- 2.6 Manpower Requirements
- 2.7 Reporting

Section 3 Catchment Profiling

- 3.1 Introduction
- 3.2 Factors Defining Catchment Limits
- 3.3 Catchment Profiling

Section 4 Inventory And Assessment Of Existing Sewerage Facilities

- 4.1 Preamble
- 4.2 Overview of Sewerage Service Areas
- 4.3 Sewers
- 4.4 Pump Stations
- 4.5 Sewage Treatment Plants
- 4.6 Bio-solid Processing
- 4.7 Disposal Trends

Section 5 Estimation Of Sewage Flows, Pollutant Loads And Bio-solid Generation Rates

- 5.1 Introduction
- 5.2 Sewage Flows
- 5.3 Sewage Pollutants
- 5.4 Estimation of Sewage Flows
- 5.5 Pollutant Load Projections
- 5.6 Sewage Bio-solid Quantifications

Section 6 Issues And Constraints

- 6.1 Introduction
- 6.2 Rating of Existing Sewerage Systems
- 6.3 Issues and Constraints Relevant to Identifying Appropriate Sewerage Service Strategies
- 6.4 Issues Pertinent to Developers

Section 7 Identification And Assessment Of Optional Sewerage Management Strategies

- 7.1 Introduction
- 7.2 Initial Screening of Options
- 7.3 Sewerage Management Alternatives
- 7.4 Identification of Options for Analysis
- 7.5 Listing of Favourable Options
- 7.6 Post Script

Section 8 Financial Analysis Of Options

- 8.1 Introduction
- 8.2 Costing Basis
- 8.3 Life of Assets and Residual Value
- 8.4 Running (Operating and Maintenance) Costs
- 8.5 Net Present Value and B/C

Section 9 Selection Of Preferred Option

- 9.1 Introduction
- 9.2 Collation of Pertinent Information
- 9.3 Evaluation Based on Financial Considerations

- 9.4 Evaluation Based on Technical Considerations
- 9.5 Evaluation Based on Environmental Considerations
- 9.6 Overall Assessment and Selection of Preferred Option
- 9.7 Optimisation of Preferred Option

Appendix A Sources of Information

- Appendix B** A1 Potential Services of Basic Information
Qualification And Quantification Of Sewage Flow and Pollutant Load Characteristics
 - B1 Introduction
 - B2 Sewage Flows
 - B3 Pollutant Loads
 - B4 Bio-solid Characteristics
 - B5 Factors Considered in Predicting Population Growth
- Appendix C** **Estimation Of Sewage Treatment Plant Plot Areas**
 - C1 Empirical Estimates of Area Requirements for Different Types of Sewage Treatment Plants
- Appendix D** **Methods For Population Forecast**
 - D1 Population Forecast
 - D2 Demographic Method of Population Projection
 - D3 Arithmethical Increase Method
 - D4 Incremental Increase Method
 - D5 Geometrical Increase Method
 - D6 Decreasing Rate of Growth
 - D7 Graphical Method
 - D8 Logistic Method
 - D9 Method of Density
 - D10 Final Forecast
- Appendix E** **Basic Approaches for making Alternative**
 - E1 Introduction
 - E2 Example of Analysis Approaches
 - E3 Conclusion
- Appendix F** **Glossary of Abbreviations**
 - Glossary of Abbreviations

SECTION 1

Introduction To The Manual

1.1 Purpose

General

The primary intent of this Manual is to provide guidance for formulating sewerage strategies for defined Catchment Areas; irrespective of whether they are urbanised or rural in character, or whether centralised sewerage systems are existing or absent. This Manual should be read in conjunction with the Catchment Strategy Report Volume 1 Part B issued by the Sewerage Services Department. The latter document spells out the basic ingredients for preparation of catchment strategy report.

Definition of a Catchment

A Catchment is broadly defined as a composite area with well demarcated boundaries within which independent self contained sewerage services can be instituted and managed on an economic footing whilst meeting regulatory standards on treated effluent discharges.

The planning scope addressed in this Manual covers both broad base (large) catchments (such as the entire City of Kuala Lumpur or Pulau Pinang or an entire Local Authority Area), as well as individual or collective catchments of a smaller areal size (e.g. covering only major housing estates or discrete areas within Local Authority boundaries).

Caters to Developers Seeking Sewerage Approvals

Developers may also depend or refer to this Manual when preparing sewerage catchment plans, as required by the Director General of Sewerage Services when applying for Sewerage Planning Approval.

1.2 Objectives

Standardised Approach and Methodology

The primary objective of this Manual is to promote and instill a *Standardised Approach and Methodology* for undertaking Sewerage Planning Studies on a Catchment level basis; and for presenting the findings in a systematic and logical manner so that it can be expeditiously reviewed, practically implemented, and thereafter used as a basis to update on sewerage strategies on a long term basis.

The Approach presented in this Manual is for preparing comprehensive Sewerage Service Plans which are regionally biased; and which are focused on promoting sewerage schemes to serve various types of land uses and physical developments located within a Catchment. It also emphasises on the need to view sewerage provisions for a single development as being an integrated component of an optimised, synergistic, sewerage scheme covering the entire Catchment in which the development is located. The same principal also applies for new or expanding

developments occurring within a Catchment. In this manner sewerage strategies for a particular catchment can be progressively updated each time a new or expanding development is proposed.

Non-Restrictive Methodologies

The methodologies described in this document are not meant to be restrictive, rather they are to be considered as basic, fundamental procedures that have been successfully applied in the past to formulate Sewerage Service Plans on a regional or local scale, i.e. covering single or multiple Catchments. Their content can be expanded, modified and refined as required, so long as the objectives and basic requirements for sewerage catchment planning, as identified in this Manual, are not deviated from, or compromised.

1.3 Governing Principles

This Sewerage Catchment Planning Manual is governed by the following principles, viz:

Caters for Domestic Sewage

Sewerage Catchment Planning shall specifically relate to the management of 'domestic' sewage flows. Domestic sewage flows are defined as wastewaters that are discharged from a residential dwelling, from public toilets, from laundries, from toilets, kitchens and canteens that are located in commercial, institutional and industrial buildings, and from hospitals and restaurants. **Sullage is which is component of domestic sewage is defined as wastewater that does not include human excreta, such as wastewater discharged from kitchens and so on.** Manufacturing related process wastewaters that are suitably pretreated so that its pollutant characteristics are similar to that of untreated sewage may also be considered to be covered by this definition. Excluded are untreated process waters from industrial establishments, cooling tower effluent discharges and steam blowdowns.

Sewerage System

This Planning Manual focuses on the development of sewerage systems. They are a basic infrastructural component of built-up areas that support relatively high population densities. They include all physical facilities involved with the collection of sewage at source, conveyance to a treatment facility, its treatment to conform to effluent discharge standards, and finally either its disposal to the environment, or its reuse as irrigation waters or for other accepted purposes. The physical assets associated with a sewage system would include:

- ◆ *Property Connection* which channel sewage from individual building(s) to the nearest public reticulation sewer, or directly to an on-site treatment plant (minimum 150mm in diameter).

- ◆ Reticulation sewers of relatively small diameters (225mm to 300mm diameter) which channel sewage collected from groups of individual properties to branch sewers (300mm to 450mm diameter).
- ◆ Branch sewers (300mm to 450mm diameter) which receive sewage from reticulation sewers and thereafter transfers the flow to small sewage treatment plants, or to main sewers (450mm to 900mm diameter).
- ◆ Main sewers (450mm to 900mm diameter) which receive sewers from branch sewers and thereafter transfer flows to small sewage treatment plant or to trunk sewers (greater than 900mm diameter).
- ◆ Trunk sewers (greater than 900mm diameter) form the spine of a large catchment and transfers sewage to a large sewage treatment plant.
- ◆ Sewage treatment plants (STP) which converts the sewage into a form which can be safely discharged to the environment, or reused for various compatible purposes.
- ◆ Bio-solid treatment and disposal facilities which cater for low solids content bio-solid that are generated by STPs. Sewage bio-solid management facilities can be part of an overall STP, or installed as a separate entity at centralised bio-solid processing centres. Facilities are provided to:
 - thicken the bio-solid in order to reduce its volume so that it can be more economically processed thereafter.
 - stabilise bio-solid by reducing its degradable organic content and pathogenic properties.
 - dewater the stabilised bio-solid to further increase its solids content (>25%) such that it becomes “spadeable”, and more easily handled and transported to approved disposal centres.
- ◆ Systems to dispose or reuse the processed bio-solid.

Exclusion

A building’s internal plumbing (or soil pipes) within the buildings lot boundary which handles sewage flows at generation points are excluded from consideration.

Separate Sewer Systems

Sewerage Catchment Planning shall focus only on implementation of *separate sewer* systems that cater for raw sewage discharges exclusively. They shall not be planned to accommodate storm water runoffs (e.g. rain water collected from building roofs, courtyards and street pavements). However allowances should be incorporated in sewerage planning to accommodate storm waters that may *unintentionally or inadvertently* be introduced into the sewerage system (e.g. through uncovered manholes, leaking pipe joints and manhole structures, and illegal roof drainage connections).

Cater for Growth Areas

In sewerage catchment planning special emphasis shall be made to cater for *Growth Areas*. Growth Areas are defined as new developments occurring within a Catchment which are required to pay a *Contribution Fee* in order that central sewerage services can be planned and adequately provided to cater for their sewage discharges.

Environmental Implications

Sewerage Planning shall take due cognizance of protecting the aesthetic, recreational and biological values of water courses. In addition, sewerage planning for catchments which contribute to the water resource potential of public water supply systems should be prioritised to ensure adequate protection of raw water intakes.

1.4 Content

The Planning Manual identifies the basic factors and criteria which have to be considered when formulating Sewerage Catchment Plans, and describes a systematic approach to achieve this goal. It outlines the scope of baseline data that needs to be garnered, and discusses procedures for interpreting and analysing the data with a view towards deriving useful information that can be applied to formulate a rationalised, integrated Plan which is cost effective and affordable, and which can cater for the short, medium and long term sewerage needs of a Catchment. [It is discussed ultimate disposal strategy of the dewatered bio-solid for immediate, short and long term plan.](#) It also discusses the bases for identifying a staged affordable sewerage facility implementation programme which can alleviate existing sewerage service deficiencies, cater for projected growth areas (i.e. increasing sewage flow generation in the foreseeable long term), and ensure compliance with established effluent quality discharge standards and other legislative requirements.

In line with the above approach, this Manual relates the methodologies that can be applied to (a) establish or define Catchment boundaries, (b) estimate sewage flow and sewage bio-solid generation rates within the Catchment at specific intervals throughout a selected planning period, (c) assess existing sewerage service deficiencies within the Catchment, (d) identify appropriate sewage and bio-solid collection, conveyance, treatment and disposal *concepts* which can redress the catchment's existing sewerage deficiencies and cater for its future needs, (e) compare and evaluate the technical, financial, economic and environmental impact characteristics of concepts identified so that they can be ranked in terms of overall suitability, with a view to justify selection of a preferred Sewerage Catchment Plan, (f) specify short, medium and long term implementation schemes for sewerage and bio-solid collection, conveyance, treatment and disposal facilities that can fulfill the goals of the preferred Sewerage Catchment Plan, (g) estimate staged and cumulative Capital, and Operation and Maintenance costs over the Planning Period, and (h) identify funding schemes to support the selected Sewerage Catchment Plan.

1.5 Structure

The content of this Planning Manual has been structured to present a systematic discussion on how a Sewerage Catchment Planning exercise should be conducted and reported.

The *next chapter* presents a summarised account of the basic principals associated with sewerage catchment planning; and the manpower requirements needed to conduct such a Study.

Chapter Three identifies the factors to be taken into account in delineating sewerage catchment boundaries and in defining the Study Area as a whole.

Chapter Four explains the necessary scope and detail involved in identifying, assessing and evaluating the status of existing sewerage facilities within a demarcated catchment area.

Chapter Five describes the flow and pollutant load characteristics of sewage and sewage bio-solids; and identifies suitable criteria for estimating sewage flow discharges from different types of premises, and bio-solid generation by different types of sewage treatment plants (STPs). Methodologies for estimating current, and predicting future, sewage flow quantities, pollutant loads and bio-solid quantities are discussed; with emphasis placed on identifying factors that are to be considered when predicting future flow generation rates on a realistic basis.

Chapter Six relates the issues and constraints that need to be considered when identifying strategies for upgrading and consolidating existing sewerage systems, and for introducing new systems to cater for growth areas within a defined Catchment Area. This step is a necessary precursor for identifying optional upgrading and expanding sewerage strategies for in-depth comprehensive analyses.

Chapter Seven describes the bases for choosing a number of suitable alternative sewerage service strategies to address identified issues and constraints. It further discusses the manner by which the alternative strategies can be screened so that a limited number are finally selected for detailed analyses, with a view towards ranking them in order of overall suitability.

Chapter Eight the financial aspects of sewerage catchment planning are described and explained; especially in relation to its importance and influence in dictating first of all the elimination of unfavourable strategies, and subsequently in selecting a preferred Sewerage Catchment Plan.

Chapter Nine deliberates on the basic approach and methodologies that can be applied for selecting a preferred Sewerage Catchment Plan amongst short listed options. In addition the derivation of a staged programme to implement the preferred Plan over a selected tenure is explained. The important aspect of funding staged programmes are also discussed.

SECTION 2

Basic Principles Governing the Conduct of Sewerage Catchment Planning

2.1 Introduction

The objectives and need for Sewerage Catchment Planning are explained in this Chapter. Fundamentals involved in formulating a Sewerage Catchment Plan are explained.

Sewerage Catchment Planning

Sewerage catchment planning, which represents one facet of overall Infrastructural Catchment Planning, is specifically concerned with identifying structural as well as non-structural measures that will ensure the safe management and disposal of sewage generated within a defined area, so that desired public health, aesthetic and environmental quality standards within its boundaries, or its neighbouring or conjugative areas, are not compromised or degraded. Sewerage Catchment Planning encompasses the management of both the liquid and solids fraction of sewage.

Holistic Approach

A holistic approach is needed when undertaking sewerage catchment planning studies; as in the case for all other infrastructural planning studies. This would involve making a concerted effort to garner reliable baseline information on existing development patterns and sewerage provisions, and to predict as accurately as possible future development patterns and corresponding need for enhanced updated sewerage services.

Techno-Economic Issues

Techno-economic issues are important factors in charting a workable, flexible, Sewerage Catchment Plan (SCP). Sufficient foresight is needed to predict service requirements fifteen to twenty years in the future. A SCP which cannot be funded, adequately managed (i.e. availability of trained manpower resources), or which is constrained in its ability to generate sufficient revenue is practically worthless.

Equal Importance on Bio-solid Management

In Sewerage Catchment Planning studies equal importance has to be placed on the collection, conveyance, treatment and disposal of liquid sewage as well as sewage bio-solid. In the past very little attention has been placed on sewage bio-solid management, with the result that, currently, residual bio-solid disposal is a major problem faced by the Sewerage Service Operator.

Specific Ingredients and Perspectives of a Catchment Plan

A catchment plan is essential for the efficient development and management of sewerage systems to serve current and future developments and to meet environmental quality and public health goals of a region. It should provide an optimised return on investments to meet capital and operating costs. In addition the plan should account for other relevant factors including impacts on the

environment, socio-political considerations, level of technology, skills required, availability of equipment and personnel. Catchment plans are usually developed to serve a community for the short, medium and long terms. Planning information such as population projections are rarely considered to be reliable beyond 20 years. The catchment plan is generally developed to fit within this planning horizon, but should be valid for longer. This necessity to meet future developments which cannot be accurately predicted, means that the catchment plan must be flexible. Catchment plans are often developed using time periods matching the economic life of sewerage assets which average approximately 20 to 25 years.

2.2 Basic Objectives and Needs

Objectives

Safeguard Environmental Values and Public Health

The primary aim or objective of Sewerage Catchment Planning is to ensure that sewage flows generated within Catchment Areas, together with its inherent pollutant forms, are safely managed, without causing detrimental impacts on the local and regional environments.

Other Aims

In conforming to this primary goal, other objectives to be attained include:

- ◆ The appropriate definition of boundaries for a Catchment that will not only optimise the management of sewerage services within its area of influence, but one which could also support and enhance sewerage services in adjoining catchments if required.
- ◆ Estimating with adequate accuracy the generation of current and future sewage flows and pollutant loads within a specified Catchment.
- ◆ Outlining broad sewerage facility implementation strategies for the catchment that are in conformance with the objectives of the National Sewerage Privatisation Programme.
- ◆ Maximising the use of existing sewerage facilities within a Catchment to serve a particular Development; and/or to cater for future sewage flow generation by anticipated development schemes.
- ◆ Ensuring a staged implementation of identified sewerage facilities which are affordable, which can be adequately managed and maintained, and which can be effectively administered to cater for existing and future sewage flows and inherent pollutant loads.

Need for Sewerage Catchment Planning

Sewage in its generated form harbours a variety of pollutants which can impact adversely on the physical, biological and human value components of the environment.

Concern Over Pollutants Present in Sewage

The cause for concern over pollutants present in raw sewage flows is best summarised in *Table 2.1* below:

Table 2.1 Contaminants in Sewage and Reasons for Health or Environmental Concern

Contaminants	Reason for Importance
Suspended solids	Suspended solids can lead to the development of bio-solid deposits and anaerobic conditions when untreated wastewater is discharged in the aquatic environment.
Biodegradable organics	Composed principally of proteins, carbohydrates and fats, biodegradable organics are measured most commonly in terms of BOD (biochemical oxygen demand). If discharged untreated to the environment, their biological stabilisation can lead to the depletion of natural oxygen resources and to the development of septic conditions.
Pathogens	Communicable diseases can be transmitted by the pathogenic organisms in wastewater.
Nutrients	Both nitrogen and phosphorus, along with carbon, are essential nutrients for growth. When discharged to the aquatic environment, these nutrients can lead to the growth of undesirable aquatic life. When discharged in excessive amounts on land, they can also lead to the pollution of groundwater.
Refractory Organics	These organics tend to resist conventional methods of wastewater treatment. Typical examples include surfactants, phenols and agriculture pesticides.
Heavy Metals	Heavy metals are usually added to wastewater from commercial and industrial activities and may have to be removed if the wastewater is to be reused.
Dissolved Inorganic Solids	Inorganic constituents such as calcium, sodium and sulphate are added to the original domestic water supply as a result of water use and may have to be removed if wastewater is to be reused.
Oil and Grease	Substances that are capable of depleting the oxygen reserves of water courses, and as a consequence causing adverse impacts on the longevity of aquatic flora and fauna, and benthic organisms, and on the aesthetics and resource value of water courses.

In consequence of the above, raw sewage has to be *adequately treated* prior to its release to the environment. Treatment reduces the potency of pollutants present in raw sewage to a level where they can be readily assimilated or accommodated by the environment without harming the health and welfare status of communities, the well being of terrestrial and aquatic ecosystems, and the desired aesthetic value of an environment.

Particular Concerns of a Sewerage Catchment Plan

As such Sewerage Catchment Planning is concerned with identifying strategies and implementing facilities to collect and convey sewage flows released at source to a treatment plant, or plants, without exposing it to the environment; and thereafter to treat it adequately so that the liquid and solids fraction of the raw sewage can be safely released to the environment associated with the defined Catchment, and/or its neighbouring areas.

Varying Needs

The specific needs of a Catchment can vary over its confined area, depending significantly on the form, density and rate of development and population levels. Low population and physical development patterns may warrant treatment of sewage at source (on-site treatment); on the other hand high density urban environments are best served by treatment plants located at a central point away from the sources of sewage generation.

2.3 Community Wide Approach

Planning for whole community

A sewerage management system is one component of an urban environment's total infrastructure system. This form of infrastructure represents a long term asset; for example sewers are expected to have a viable life up to 100 years, and even mechanical and electrical equipment is expected to last as long as 20 years. Hence once a sewerage system is constructed it will be part of the urban structure for the foreseeable future.

Once implemented the sewerage system is an interconnected entity, so it is not feasible to rearrange or redirect components of the system without major physical disruption and significant capital expenditure. As such a sewerage system represents a major investment by the community.

Running costs are as important as capital costs

The investment is not restricted to initial capital expenditures but includes all of the operation and maintenance costs. These running costs will be incurred for many decades and as such will be more substantial than the effective capital sum expended. Recurrent costs will include both obvious items such as chemical and power usage, hiring of personnel, and less obvious items such as management and overhead costs (e.g. monitoring costs). It will also effectively commit part of the available land, and services, for the life of the asset.

Cater for Community Interests

The sewerage system therefore is a series of inter-connected assets which needs to be planned, designed, constructed and operated for maximum community benefit. Hence at the planning stage the system should be selected based upon the best

interests of the total community and not specifically optimised to benefit a particular beneficiary or group of beneficiaries.

Current Management and Administration

Currently public sewerage systems in Malaysia are managed and operated by a Private Concessionaire. The system is subjected to external effects including economic viability and social policy, and regulation by the Sewerage Services Department (SSD). The Private Concessionaire who is responsible for the management and operation of the sewerage system will impose particular conditions and constraints on the required plan. It is important that this is recognised and that close liaison be maintained with the Private Concessionaire and the SSD during Sewerage Catchment Planning Studies.

2.4 General Policies Governing Sewerage Management

General policies have been evolved to guide sewerage catchment planning within Malaysia. They take into consideration the need to operate existing systems and to build and operate new Works. The basic policies are as follows:

National basis

- ◆ Policies and procedures will be applied on a national basis with the aim to provide all customers with the same level of service.

Cost recovery

- ◆ All costs associated with the provision of sewerage services will be recovered, this includes the costs to provide sewerage infrastructure for new developments.
- ◆ Direct recovery of capital costs will only apply to the *growth component* of all capital works and developments.

Responsibility of Developers

- ◆ Developers will be encouraged to act together and coordinate their developments with sewerage works proposed by the Private Concessionaire with the objective of providing a more efficient and effective sewerage system.

The following general policies have been developed specifically for the purpose of planning sewerage systems. These policies will tend to be favoured for all systems unless specific local conditions provide reasons to favour alternative policies:

Synergistic Development

- ◆ Land will be identified and set aside for sewage collection, sewage treatment and bio-solid management at the earliest possible date. The land must be

suitable for the use intended. They must be sufficient to meet the needs of the existing and ultimate development in the area; and to cater for the most stringent effluent quality discharge standards anticipated.

Rationalisation of Sewage Treatment Plants

- ◆ Sewerage infrastructure will move towards realising a more rationalised system that advocates fewer number of treatment plants. In this respect provision of a single large sewage treatment plant (STP) or Bio-solid Treatment Facility (STF) is preferred to the provision of multiple sewage treatment plants and bio-solid treatment facilities (and associated sewerage infrastructure) to serve various stages of development within a Catchment.

The use of individual and communal septic tanks and Imhoff tanks is not considered suitable. If septic tanks (or equivalent) are installed as part of an early stage of a development they will only be considered as temporary works. New Imhoff Tanks are not to be considered in any circumstance.

- ◆ Developments should connect to existing sewage treatment plants rather than construct new smaller systems if the existing sewage treatment plants can be upgraded or augmented.

Bio-solid Management Required

- ◆ All sewage treatment plants other than septic tanks, Imhoff Tanks and small package plants must be able to demonstrate that methods available for bio-solid management; which in turn must comply with Sewerage Services Department guidelines and standards concerning their treatment and disposal. Suitable access must be provided for bio-solid removal at all STPs.
- ◆ Bio-solid from Imhoff tanks, small package plants and septic tanks shall be treated at a regional facility wherever possible which may be located at the same site as a permanent sewage treatment plant or at an independent site.

Siting of Sewage Treatment Plants

- ◆ Sewage treatment plants should not be constructed inside or underneath buildings. Such construction will require stringent health and safety conditions plus additional costs for operation and maintenance. Any such plants will only be considered as temporary works.
- ◆ The location of the temporary STPs should coincide with the approved catchment strategies of the particular area to facilitate easier and economical rationalisation of the STPs in the ultimate term.

Buffer Zones

- ◆ All sewage treatment plants and bio-solid facilities must be provided with a buffer zone in compliance with guidelines established by the Sewerage Services Department. The buffer zone must be suitable for both existing and ultimate loads. The plants must not be located adjacent to food outlets, religious centres or preferably residences.

Disposal Standards to be Attained

- ◆ All sewage treatment plants must be designed to produce an effluent that conforms to current legislated discharge standards established by the Department of Environment Malaysia, and be capable of meeting any reasonably anticipated effluent quality in the future.
- ◆ All bio-solid to be disposed of must conform to statutory requirements established by the Department of Environment, Malaysia on bio-solid quality and disposal practices.

2.5 General Procedures for Evolving Sewerage Catchment Plans

New Developments, or existing Developments seeking expansion, together with regional planning efforts, shall include Sewerage Planning to be conducted over a related area of influence. An overall systematic procedure for evolving a Sewerage Catchment Plan is depicted in *Figure 2.1*.

A step wise approach is recommended, with analyses of alternative sewerage management schemes integrated into the overall procedure.

Sewage Treatment the Main Focus of Sewerage Catchment Planning

Sewage Treatment Plants (STP) are the most important component of a sewerage system, as they are responsible for producing an acceptable effluent which can be released to the environment. *The process of identifying and evaluating alternative sewerage management schemes should therefore focus on where, and how, sewage generated within a Catchment must be treated.* The guiding principal being the acceptable quality of effluent which can be released to the environment.

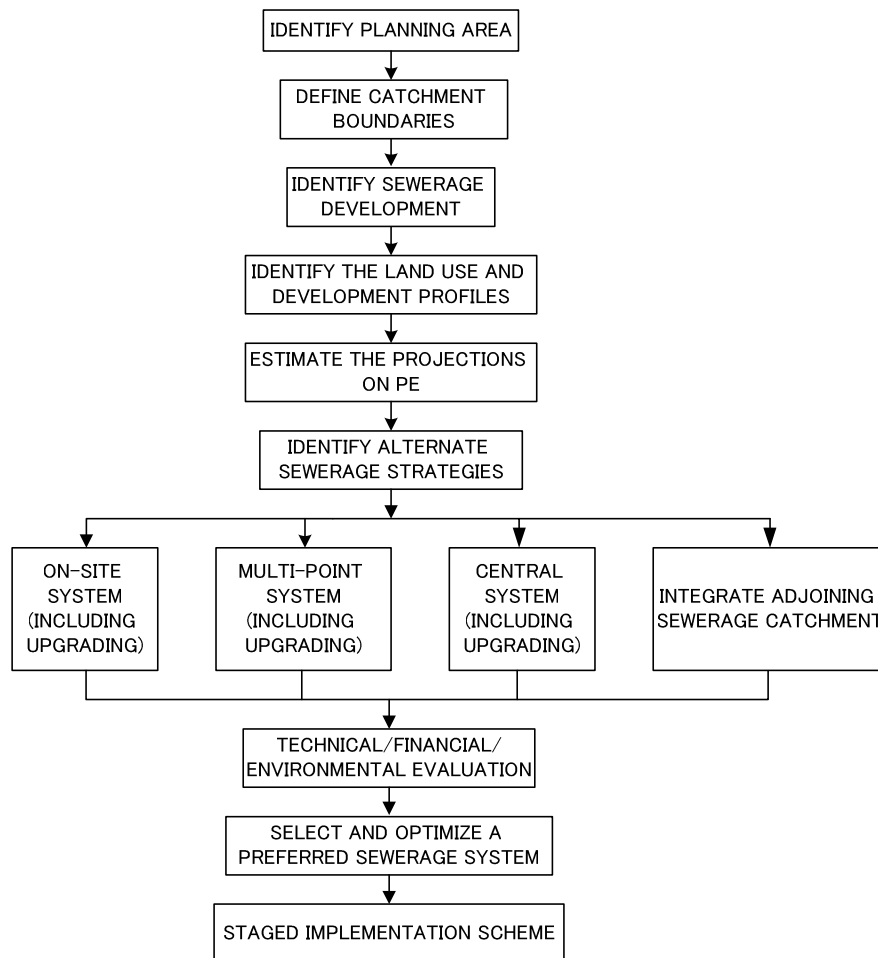

Figure 2.1 Analytical Approach for Identification of Appropriate Sewerage and Bio-solid Management Schemes

Identifying the Planning Area

The initial step in Sewerage Catchment Planning is the identification of the planning area for which the location, topography, natural drainage systems and geology are described. The location and total area covered of the planning area are described. Topography and natural drainage system are described to show the image of the array of sewers in gravity. For geology, the conditions of the soil structure and surface are described to provide basis for discussing the construction requirements of sewers and STPs.

Defining Catchment Boundaries

When defining Catchment Boundaries, the topography, administrative borders and artificial barriers such as railroads are taken into account. The boundaries of a Catchment will not only encompass identified growth areas but will assist in efforts to interpret sewerage provisions around them.

Identifying Sewerage Development

The outline of sewerage development and the condition of existing facilities conditions are described herein. In the outline, the location and number and connected PE of all IWK and privately operated sewage treatment plants, individual septic tanks and pourflush are described. For the existing facility conditions, the inventories of sewers, pump stations, sewage treatment plants, bio-solid treatment facilities are described. The number and locations of buildings with no proper sullage connected to the existing sewerage system are also described. Treatment capacities are examined by looking at design factors such as hydraulic retention time, loading rate, contact time and so on. Based on the condition of the sewage treatment facilities the present pollution load is estimated for expressing domestic sewage pollution status.

Identifying Land Use and Development Profiles

Land use and development data are important to estimate the future population used for the estimation the future sewage flow. These data quantitatively and spatially describe the present land use and developments during the sewerage planning period. The data should show the existing population dispersion in the catchment, the future population levels, the future housing estates and the future industrial and commercial areas in certain areas.

Estimation of the Projections on the Sewage Flow

Once a Catchment is defined, the extent of the Planning Period is determined. Consequently estimation of current sewage flows and those predicted to be generated in the future can be ascertained based on existing and future population levels and current and future land use and economic development trends spatially distributed over the Catchment Area. Such information is then employed to ascertain the capability of existing sewerage facilities to cater for current and future sewage flows and pollutant loadings. Information so obtained shall provide insight on the scope of rehabilitation, upgrading, or new Works that need to be implemented during various time intervals over the selected Planning Period.

Identifying Alternate Sewerage Strategies

Having reviewed the issues and implications associated with upgrading and extending sewerage services a concerted effort should first of all be made to examine alternative sewage treatment concepts that can ensure a safe disposal of treated effluent. This would include:

- ◆ Eradicating the use of septic and imhoff tank systems which have a tendency not to be maintained properly. Instead, households shall be served via a multipoint system or a centralised sewage treatment facility.
- ◆ Ensuring that all raw sewage is directed to sewerage and sewage treatment facilities and the environmental safeguards should be put into place in order to protect public health and the local water quality.

- ◆ Rehabilitation and upgrading of existing sewerage pipes to facilitate the proposed development connecting to the nearby STP.
- ◆ Eliminating STPs which are incapable of reliably meeting effluent discharge standards, and rerouting sewage flows to existing and planned treatment plants which are tailored to meet current and projected effluent discharge standards.
- ◆ Determining the type of new STPs which should be implemented so that an acceptable quality of effluent discharge can be maintained for the foreseeable future.
- ◆ Ascertaining the possibility of upgrading existing STPs to serve a higher rate of sewage flows, and yet maintain an acceptable quality of effluent discharge.
- ◆ Future bio-solid generation are also estimated based on the future sewage flows for each alternative.
- ◆ The sewage conveyance system are developed based on identified treatment concepts with special attention being focused on requirements to implement intermediate pump stations and determining the availability of land for these.
- ◆ Rationalising current STPs by reducing the number of small, limited capacity and inefficient plants, and instead implementing a single or a limited number of central STPs (say possibly within the confines of a proposed Development).
- ◆ Determining availability of land to implement permanent STP (including that available within a proposed development; such as in a new housing estate).

Figure 2.2 shows examples of alternative strategies, while Appendix E shows the basic approach for making alternatives.

Technical/Financial/Environmental Evaluation

Before conducting technical/financial/environmental evaluation, an initial screening exercise is performed in order to limit the number of alternative sewage treatment schemes to as few a number as possible (say five at the most) in order that more detailed analyses of their comparative attributes and limitations can be ascertained. Generally critical analysis is made and qualitative criteria such as available land area and environmentally sensitive area are used for the initial screening of options.

After an initial screening, alternatives are evaluated on costs, environmental impacts, operability and so on. These criteria are then systematically scored to test the overall viability of the short listed alternative schemes and to rank them in order of preference.

Selection and Optimization of Preferred Sewerage System

The most preferred alternative sewerage scheme is then subjected to further refinement with the basic aim of defining a staged programme for refurbishing and upgrading existing facilities and to install new sewerage facilities, and to estimate the staged costs for implementing the defined programmes. The economic viability associated with the staged implementation of facilities is then evaluated. This requires an evaluation of the potential revenues which can be generated to pay for capital expenditures.

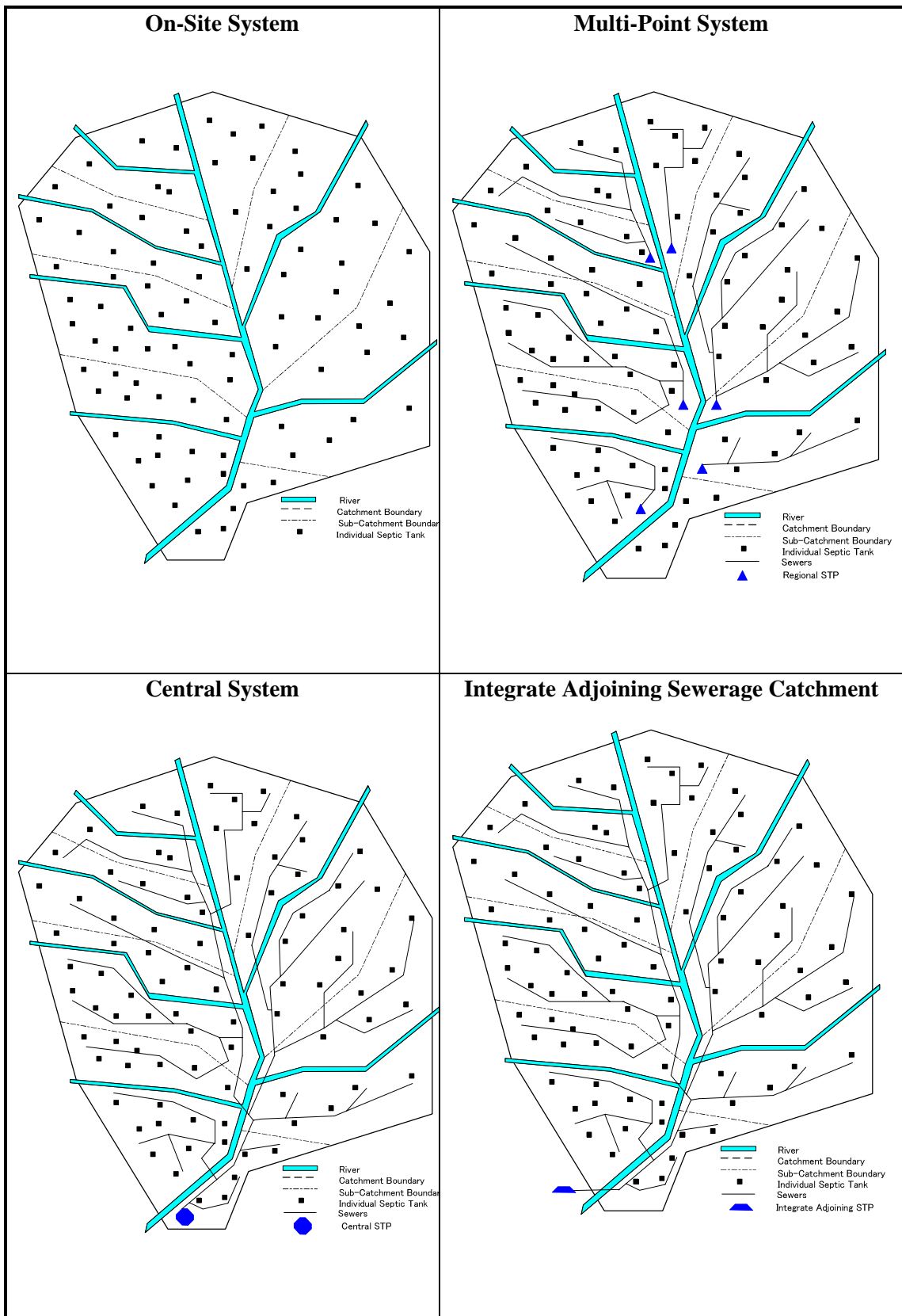

Figure 2.2 Example of Alternative Strategy

No Two Similar Catchment Plans

For each sewerage catchment plan there will be different issues to be contended with. Hence a highly prescriptive format cannot be provided. However the general approach and content will be similar. The approach relies upon developing a thorough understanding of the existing system, proposed development and relevant issues, then making a valid comparison of the available alternatives. The selected preferred option can then be defined in sufficient detail to permit the plan to form the basis for the design of the individual components of the system.

Referral Base

In developing Sewerage Plans for Catchments it is advisable that reference be made to publications such as the Sewerage Services Department's series of publications entitled Guidelines for Developers and Sirim's Malaysian Standard MS 1228 : 1991 (Code of Practice for Design and Installation of Sewerage Services). These reference documents provide relevant design criteria and guidelines to assist in the estimation of sewage flows and pollutant loads, to conduct preliminary sizing of sewerage facilities and to estimate land area requirements for establishing new sewage treatment plants and bio-solid processing facilities. Where specific information cannot be obtained from these two principal publications, recourse may be made to review other reference material covering internationally accepted sewerage facility design criteria, and sewerage management practices.

In addition discussions should be held with the system beneficiaries and with relevant Government and Private Agencies to obtain specific information on the subject Catchment. A list of potential contacts are summarised in *Appendix A*.

2.6 Manpower Requirements

An integrated team of specialists, backed-up by sub-professional and administrative staff, are needed to carry out sewerage catchment planning studies.

The Team Leader should be an experienced sewerage or environmental engineer. He should be supported by a Civil Engineer. The Study Team should preferably include an engineering economist and a town planner, the former to carry out economic/financial analyses of alternative schemes; and the latter to undertake current and future land use and development profiling, estimation of current population levels and to predict future population levels within the defined catchment area.

A sewerage catchment planning exercise requires extensive reconnaissance surveys of existing land use and developments and existing sewerage facilities such as pump stations and STPs. In addition extensive reviews of sewerage planning and design submissions have to be made. A team of technical assistants and technicians can assist the professional staff in conducting such essential tasks.

Finally a team of draftspersons and typists are required to, respectively, produce a large number of descriptive and informative figures and to type the catchment reports.

2.7 Reporting

The salient findings of a sewerage catchment planning study are required to be reported in a concise and systematic manner. All pertinent and substantive information should be included in the Report. In this context basic criteria, premises and sources of information need must be documented. The principal deductions, conclusions and recommendations should be summarised and presented in an Executive Summary.

A suitable Report Content is presented in *Volume 1, Part B Catchment Strategy Report*.

SECTION 3

Catchment Profiling

3.1 Introduction

Defining Area Limits of a Catchment

Defining the area limits of a Catchment for which sewerage planning is to be carried out is a primary goal to be achieved at the very outset of a Sewerage Catchment Planning study. This procedure establishes the areal limits within which a cost effective integrated plan for sewerage service upgrading and enhancement can be formulated.

A Sewerage Catchment can be viewed as an area over which raw sewage can be conveniently conveyed, *predominantly by gravity*, and at reasonable cost, to a treatment plant located within its confines.

A demarcated sewerage catchment area is usually segregated into a number of drainage cells or individual sub-catchments dictated mainly by physiographic profiles. Nonetheless existence of natural and artificial barriers which impede sewage flows by gravity can also influence the number of sub-catchment cells.

There are specific factors and issues that need to be considered and assessed in defining the spatial extent of a Catchment. These are elaborated herewith.

3.2 Factors Defining Catchment Limits

Topography

Theoretically a sewerage catchment would encompass a single or multiple number of natural drainage basins which permits sewage to flow entirely by gravity to a lowest point where it can be suitably treated and disposed. Topographical characteristics generally influence the size of a catchment area.

Administrative Borders

Administrative borders and availability of a vast land bank to site a large permanent STP can influence the shape and size of a Catchment Area (refer to *Figures 3.1 and 3.2*).

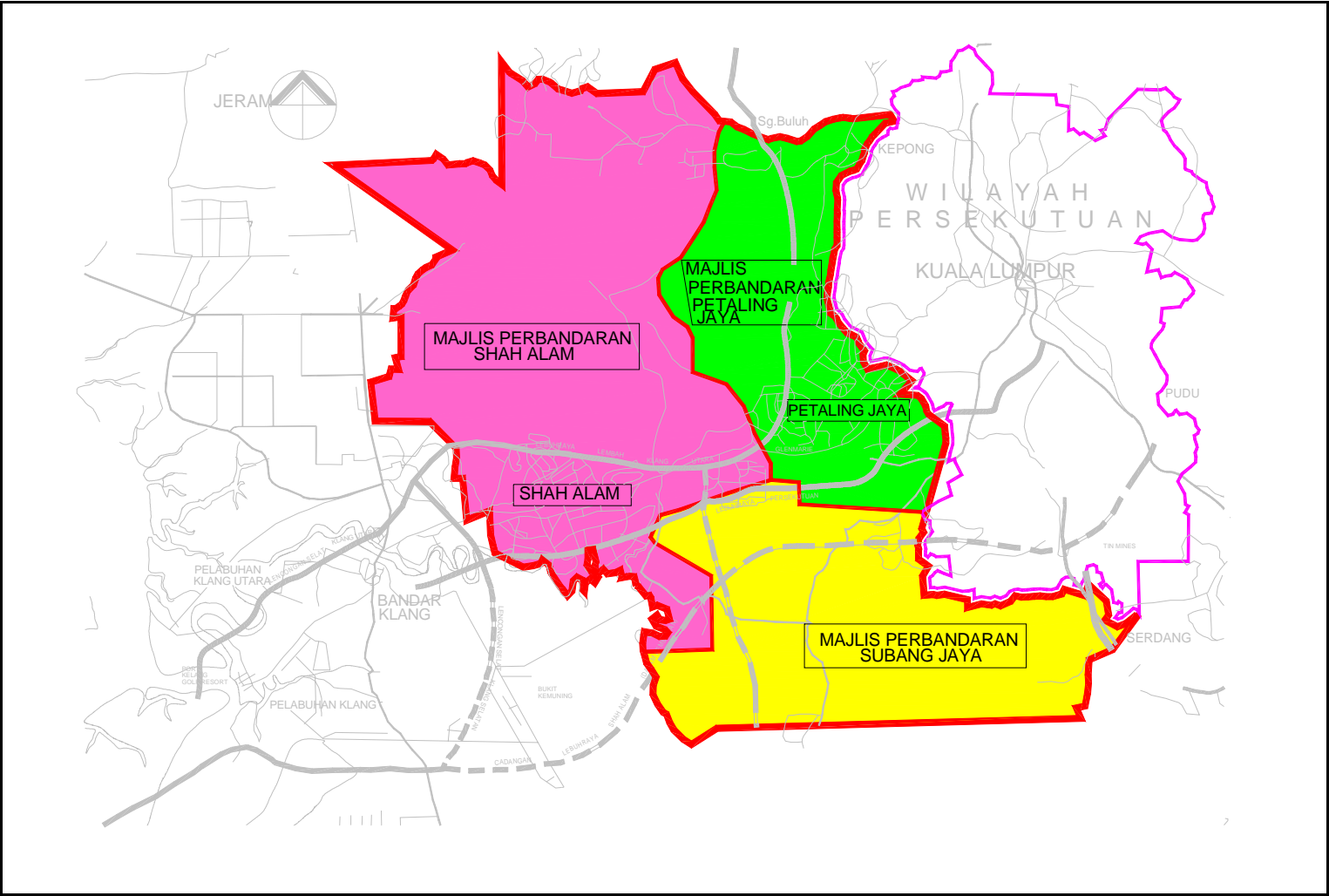

Figure 3.1 Sub-Catchment Boundaries Based on Administrative Jurisdiction

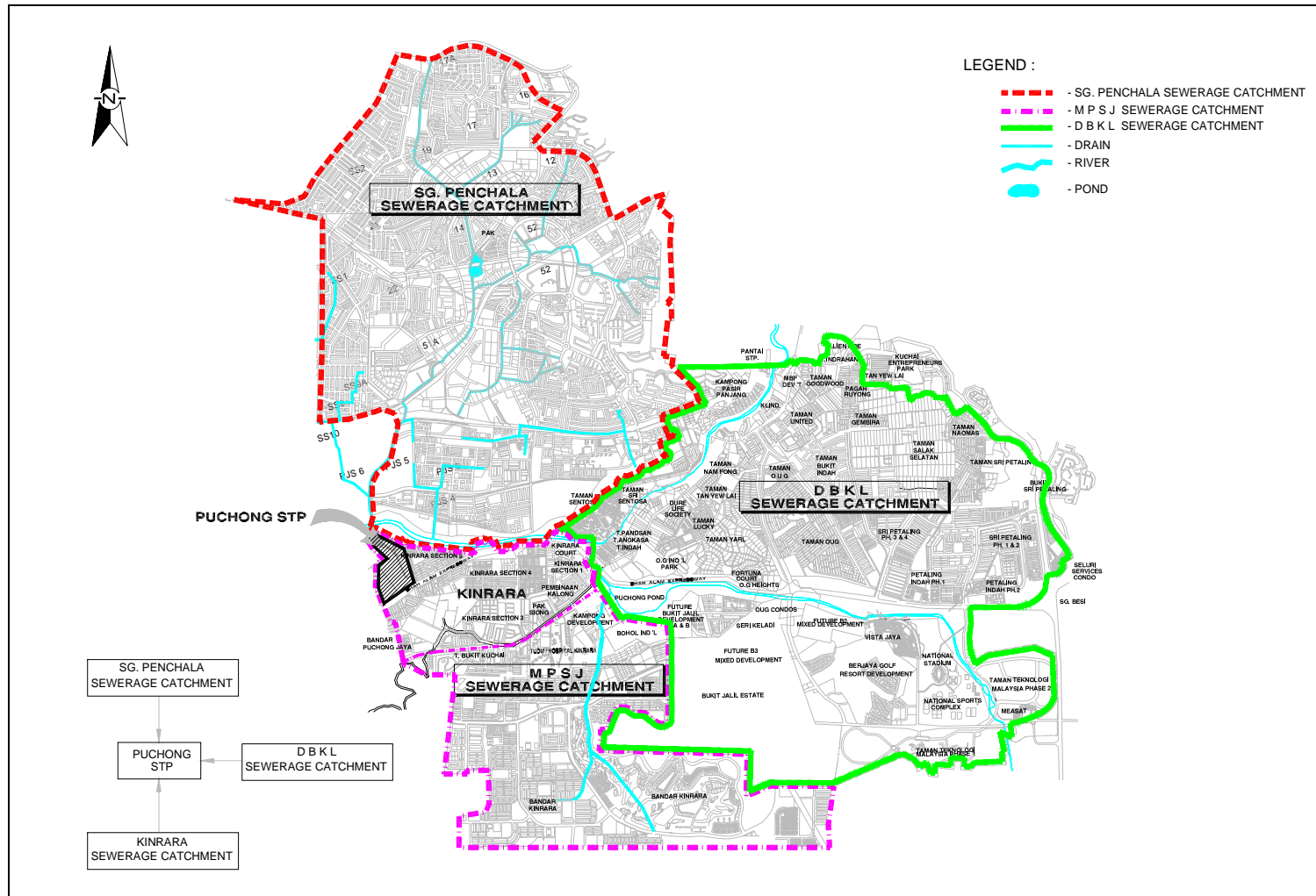

Figure 3.2 Sewerage Catchment Boundaries Influenced by Size of Sewage Treatment Plant

However there are other factors which could optimise the spatial extent and configuration of a sewerage catchment. These would include:

Natural and Artificial Barriers

- ◆ Natural and artificial (man-made) obstacles which impede the convenient flow of sewage by gravity to a central point for treatment by imposing technical barriers, or by raising the cost of conveyance to unrealistic levels, include rivers, major highways, railways, etc.
- ◆ Lack of suitable land banks to site STP within a natural drainage basin; thereby necessitating expanding the limits to cover two or more natural drainage basins.
- ◆ Availability of large tracks of land area to site high capacity STPs. This would include considering a large composite Catchment especially if adjoining areas do not have suitable land areas to site STP.
- ◆ Requirement to limit the number of intermediate pump stations within a conveyance network, that could reduce the area of a Catchment.
- ◆ Avoiding deep gravity sewers; a factor which could reduce the size of Catchments especially in relatively flat terrain.
- ◆ Selecting a suitable effluent discharge point that is located close to an STP where treated sewage can be conveniently disposed without exerting adverse water quality and/or environmental impacts.
- ◆ Complying with a policy of rationalising the extent of STPs by reducing their numbers to a minimum.
- ◆ The type and density of developments along peripheral areas lying adjacent to the catchment divides; which may extend the area of a sewerage catchment to include areas in an adjacent drainage catchment.

All of the above factors need to be reviewed in an interactive manner as they would have some form of implication on catchment sizing. A judgmental decision should be made after weighing all of the advantages and disadvantages which each factor may raise.

It is to be noted that administrative boundaries need not influence the establishment of sewerage catchment boundaries, nor should population levels and densities dictate the extent of a sewerage catchment.

3.3 Catchment Profiling

Once the overall boundaries of a sewerage catchment are defined, it is necessary to delineate the spatial distribution of sub-catchment boundaries or cells. This provides an opportunity to gauge the number of pump stations that will be required, as well as to plan out the number of permanent STPs that will lead to an optimum sewerage catchment plan (Refer to *Figure 3.3*).

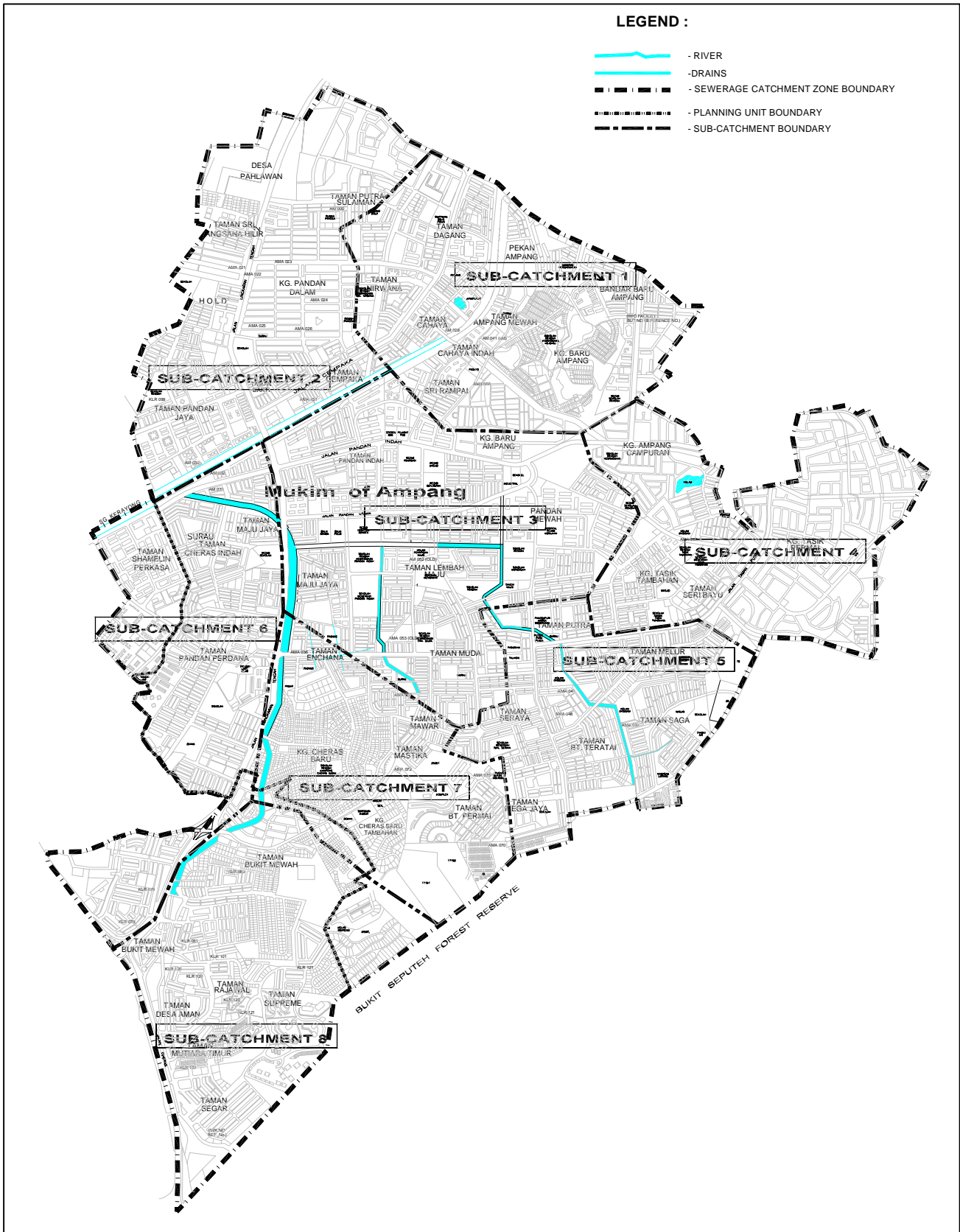

Figure 3.3 Overall and Sub-Catchment Boundaries for Upper Kerayong Sewerage Zone

SECTION 4

Inventory and Assessment of Existing Sewerage Facilities

4.1 Preamble

Appraisal of Existing Sewerage Systems

An essential task to be carried out in any Sewerage Catchment Planning exercise is an assessment of the different forms of sewerage systems existing within the demarcated catchment area. A consequential task is to carry out a comprehensive inventory of existing sewerage assets within the catchment's boundaries, and an assessment of their structural state, hydraulic capacity, functional capability and performance efficiency. Assets under construction, or to be constructed in the near future, need also to be inventorised.

The assessment should generate information which can be utilised to evaluate their further usefulness, i.e. whether they can be rehabilitated and upgraded, and whether there is a need to improve their effectiveness and performance efficiencies to cater for additional loads and to conform to stricter effluent discharge standards.

The data bank so achieved, and the deductions arising from this review, shall assist in identifying and evaluating alternative sewerage upgrading and expansion strategies.

4.2 Overview of Sewerage Service Areas

Definition of Sewerage Service Sectors

A review of the different forms of sewerage services prevailing within a Catchment, and their spatial distribution, is useful. Sewerage service is defined in accordance with the type of sewage treatment afforded; i.e. either by Individual and Communal Septic Tanks, Imhoff Tanks, Waste Stabilisation Ponds or High Rate Mechanised Biological STPs (encompassing both small package forms and medium and large scale systems).

The information so garnered should be pictorially displayed over the Catchment as independent *Sewerage Service sectors*. A typical example is depicted in *Figure 4.1*.

The demarcation of sewerage service sectors provides an indication of the extent of priority upgrading needs of the Catchment under review. Furthermore it also defines the spatial distribution of different forms of sewage bio-solids that are being produced; pertinent information that will assist in deciding on an optimum location of a centralised bio-solid treatment facility to cater for the needs of the Catchment.

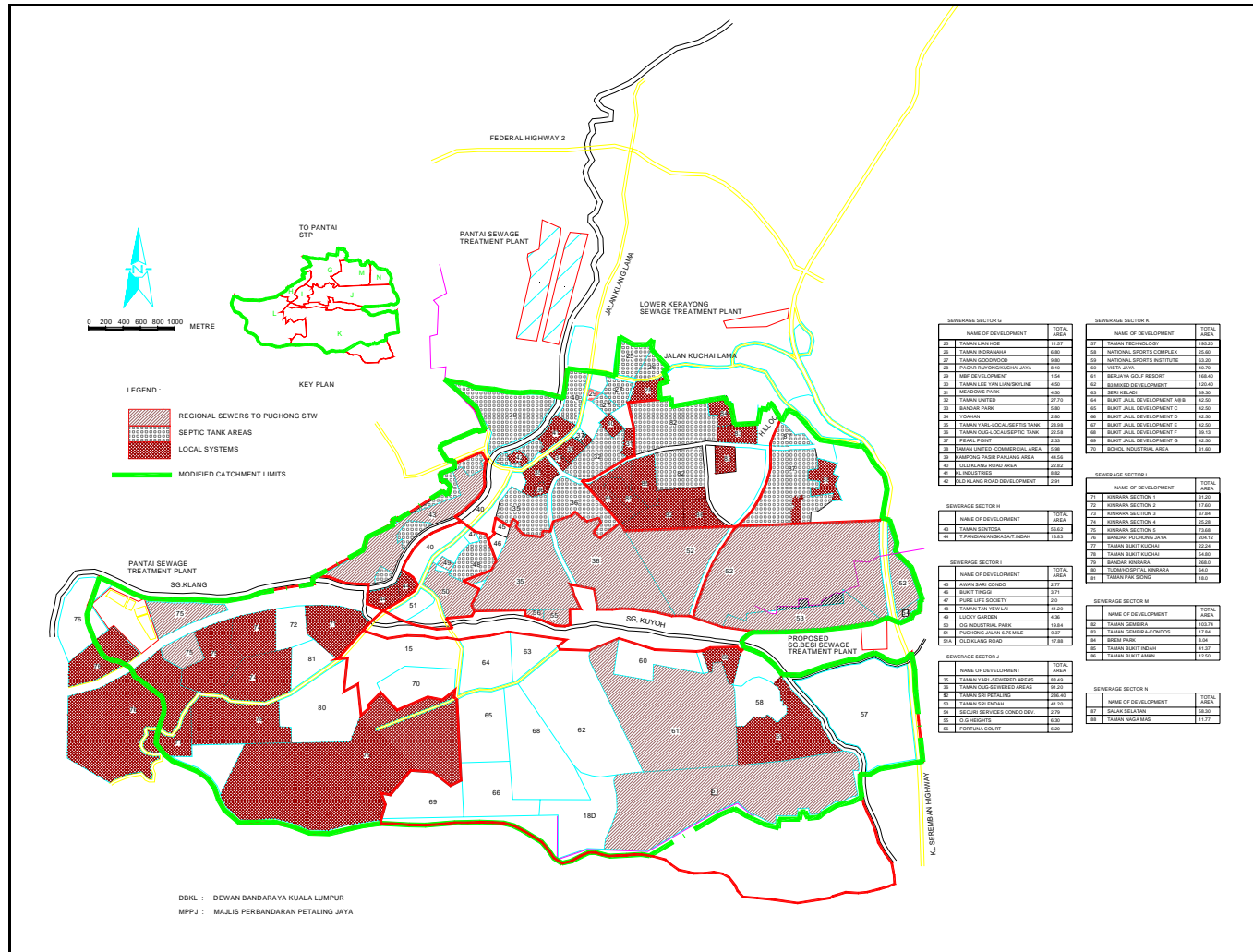

Figure 4.1 Sewerage Management Within the DBKL and MPPJ Sewerage Catchment Areas

4.3 Sewers

Sewer Inventories

The location, alignment and gradient of gravity sewers existing within a Catchment area requires inventoring. For purposes of Sewerage Catchment Planning, if data is made available, existing *trunk sewers* should be reviewed comprehensively and their location demarcated on eight (8) chain revenue sheets covering the Catchment area. A typical profile is depicted in *Figure 4.2*.

Information (if available) on the length, gradient and diameter of sewers that are *trunk sewers* should be tabulated separately as shown in *Table 4.1*.

Physical Condition

The physical condition of buried sewers may be difficult to ascertain as CCTV surveillance cannot be carried out during the tenure of a Sewerage Catchment Planning exercise. However discussions with the Sewerage Operator should be attempted to gain some insight on problematic areas which have undergone rehabilitation and maintenance in the past. Evidence of blockages should be noted for inclusion in the Sewerage Catchment Plan's rehabilitation programme for existing assets.

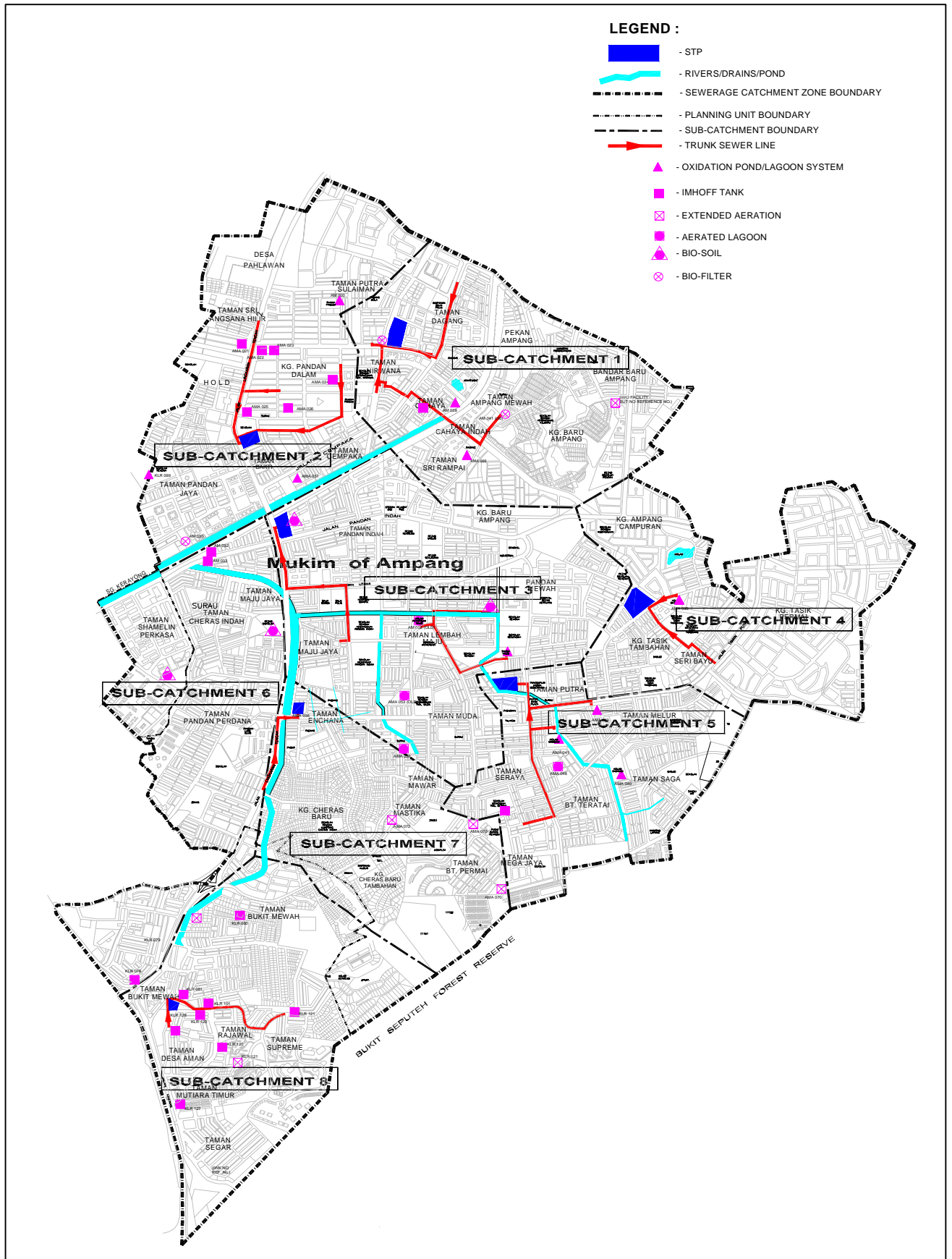

Figure 4.2 Spatial Demarcation of Sewerage Facilities Per Sub-Catchment

Table 4.1: Physical Profile of Trunk Sewers

MH.NO	GR.ELEV. (m)	INV.IN (m)	INV.OUT (m)	DEPTH (m)	SLOPE	LENGTH (m)	DIA (mm)
2C-2-7	14.11		9.20	4.91			
					0.0224	96.83	450
2C-2-6	11.35		7.03	4.32			
					0.0163	49.76	450
2C-2-5	9.88		6.22	3.66			
					0.0141	96.08	450
2C-2-4	8.12		4.86	3.26			
					0.0039	93.19	450
2C-2-3	8.05		4.50	3.56			
					0.0038	99.43	450
2C-2-2	8.16		4.12	4.05			
					0.0043	50.37	450
2C-2-1A	7.92		3.90	4.02			
					0.0040	91.26	450
2C-2-1	6.95		3.54	3.41			
					0.0339	46.04	450
1-2-9A	6.45		1.98	4.47			
1-2-10	7.12		2.09	5.03			
					0.0016	69.64	675
1-2-9A	6.45		1.98	4.47			
					0.0016	38.67	675
1-2-9	7.26		1.92	5.34			
					0.0017	60.37	675
1-2-8	6.42		1.82	4.60			
					0.0014	50.00	675
1-2-7A	6.48		1.75	4.73			
					0.0008	50.00	675
1-2-7C	6.95		1.71	5.24			
					0.0007	60.06	675
1-2-7	7.41		1.67	5.74			
					0.0016	67.99	750
1-2-6	8.01		1.56	6.45			
					0.0017	46.95	750
1-2-5A	8.55		1.48	7.07			
					0.0008	97.16	750
1-2-5	8.18		1.40	6.78			
					0.0009	65.68	750
1-2-4A	7.74		1.34	6.40			
					0.0009	90.24	750
1-2-4	7.16		1.26	5.90			

4.4 Pump Stations

Inventory of Existing Systems

The existence of intermediate pump stations which form part of an existing sewerage conveyance system should be recorded, and their positions located in the same eight chain revenue sheets employed for delineating sewer alignments.

If available information on plot shape and size, and on the foot print details of each and every intermediate pump station, should be recorded. Similarly the existence of an associated electrical substation and its rated capacity should also be recorded. In the absence of recorded information, an attempt should be made to garner such data by employing simple, convenient methods.

Physical and Functional Status

The physical and functional status of concrete structures and mechanical equipment associated with each pump station should be assessed and reported. Particular attention should be placed on ascertaining the capacity and efficiency of pump sets and screening devices. Any system malfunctions and incapability to handle sewage inflows should be ascertained and noted.

4.5 Sewage Treatment Plants

Plant Inventorisation

The type and distribution of various sewage treatment plants (STP) such as Imhoff Tanks, Waste Stabilisation Ponds, Package Plants and High Rate Mechanised Biological Treatment Systems (HRMB) should be inventorised and their locations demarcated on the same eight chain revenue sheets containing information on sewers and pump stations (*Figure 4.3*).

The design capacity of each type of STP should be tabulated, and their corresponding service areas should preferably be demarcated on eight chain revenue sheets, if such information can be deduced within the time frame of a Sewerage Catchment Planning study.

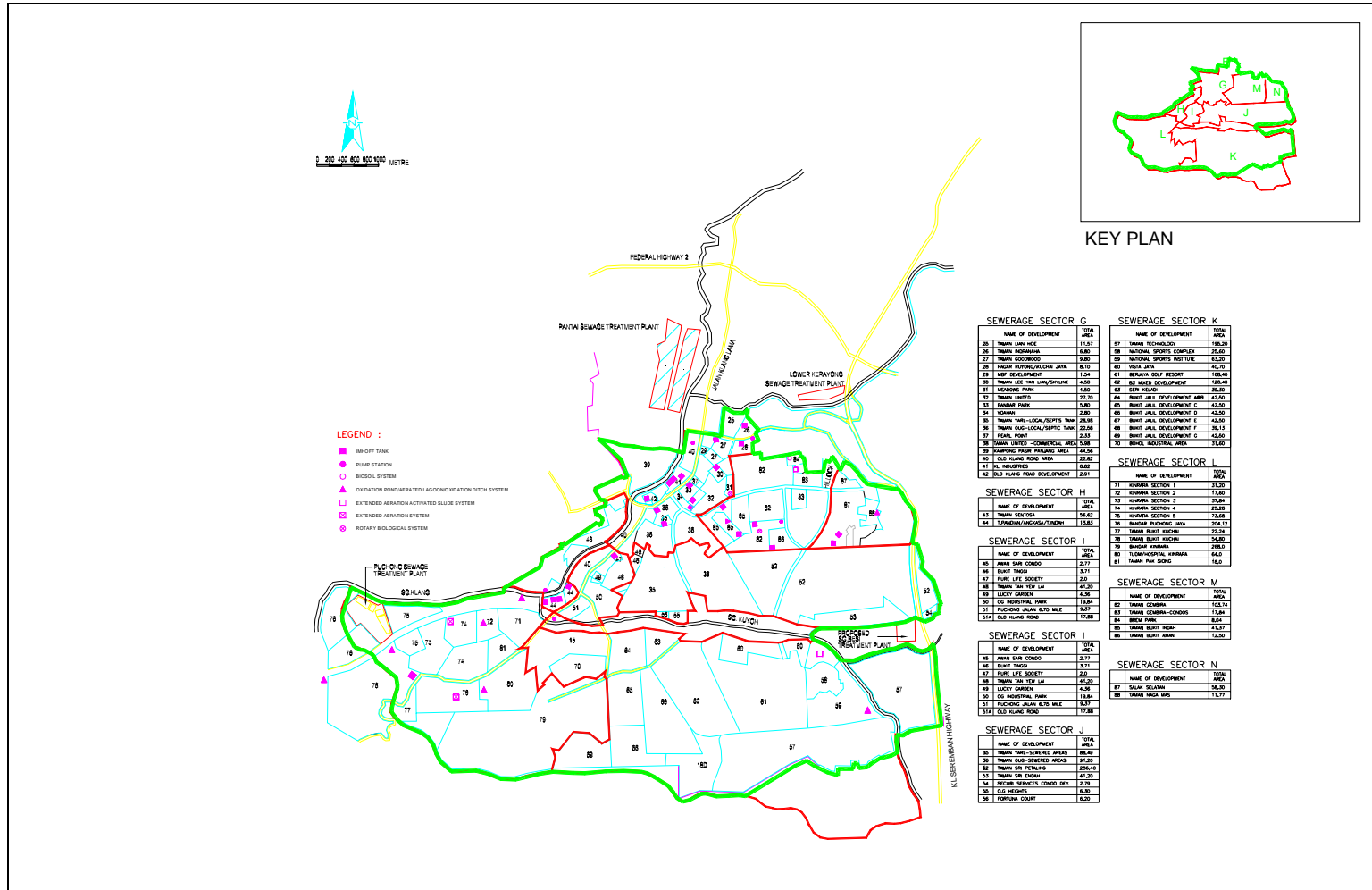

Figure 4.3 Spatial Demarcation of Existing STP's within Sg. Kelang and Sg. Kuyoh Sewerage Catchment Areas

Site Records

Wherever possible each STP should be visited to record information on

- ◆ Physical appearance and structural state
- ◆ Area size and shape of the Plot in which it is located
- ◆ Process Units which are existing
- ◆ The functional state of mechanical and electrical equipment and their individual ratings
- ◆ Final effluent discharge point
- ◆ Surrounding land use and development pattern (0.5 km radius from site)
- ◆ Any negative impacts on surrounding areas.

Process flow and layout for plants

Wherever possible a process flow diagram (*Figure 4.4*) and a layout (*Figure 4.5*) should be prepared for STPs other than Septic and Imhoff Tanks. The extent that an STP requires upgrading, or is to be upgraded, and the status and capacity of its unit processes should be assessed. This is usually carried out by evaluating the design capacity of the STP process units employing criteria published in the Sewerage Services Department's Guidelines for Developers, and then comparing such values with the respective process unit's current loading or use. The capacity of each plant's unit process as a function of the population equivalent it can cater for is then compared with the actual PE served in *Table 4.2*. Again this simplified approach has to be adopted to account for unit processes which will achieve less than the anticipated performance due to:

- ◆ poor operational practices
- ◆ poor design
- ◆ poor mechanical/electrical equipment, often due to lack of maintenance
- ◆ particular circumstances

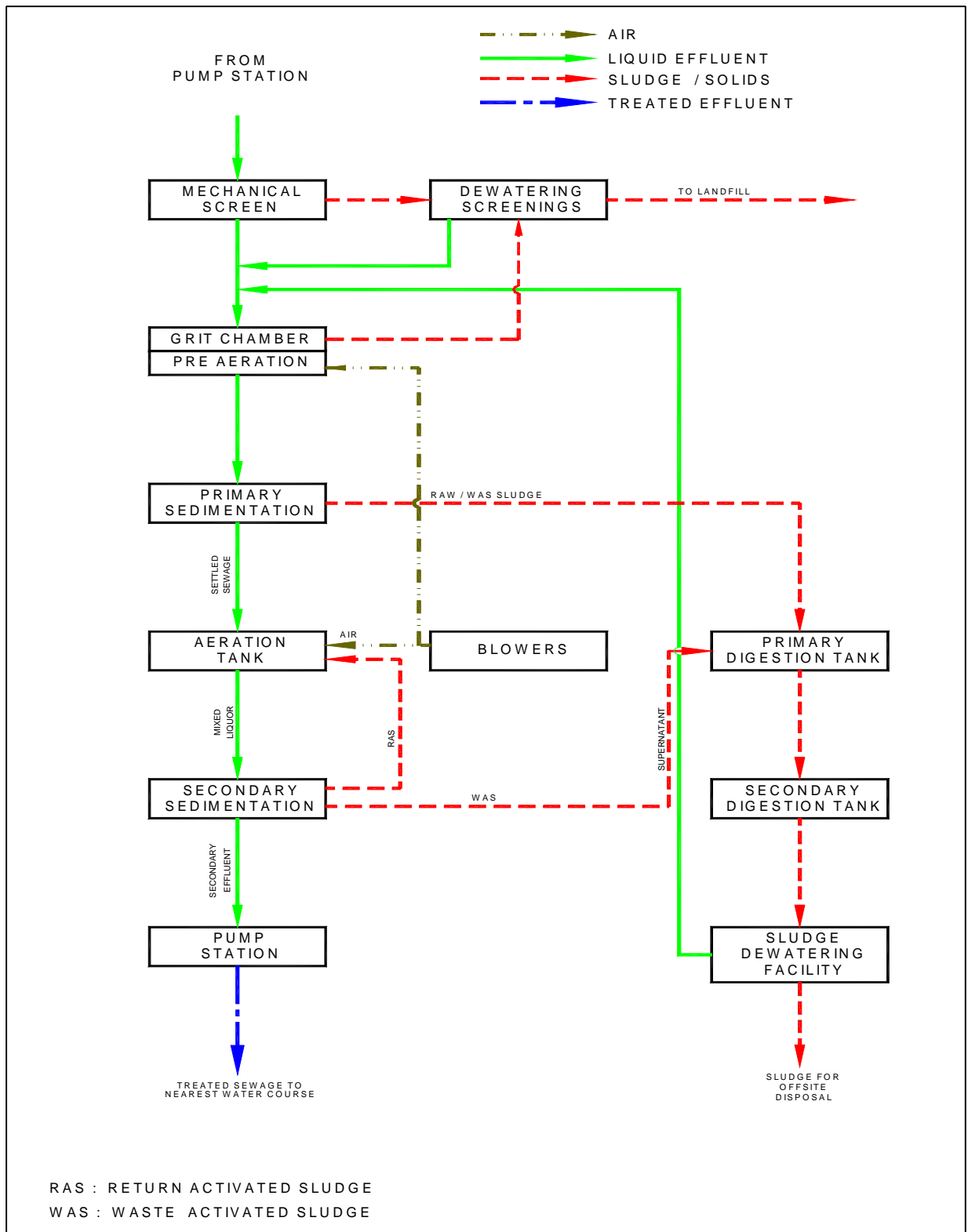

Figure 4.4 Process Flow Diagram

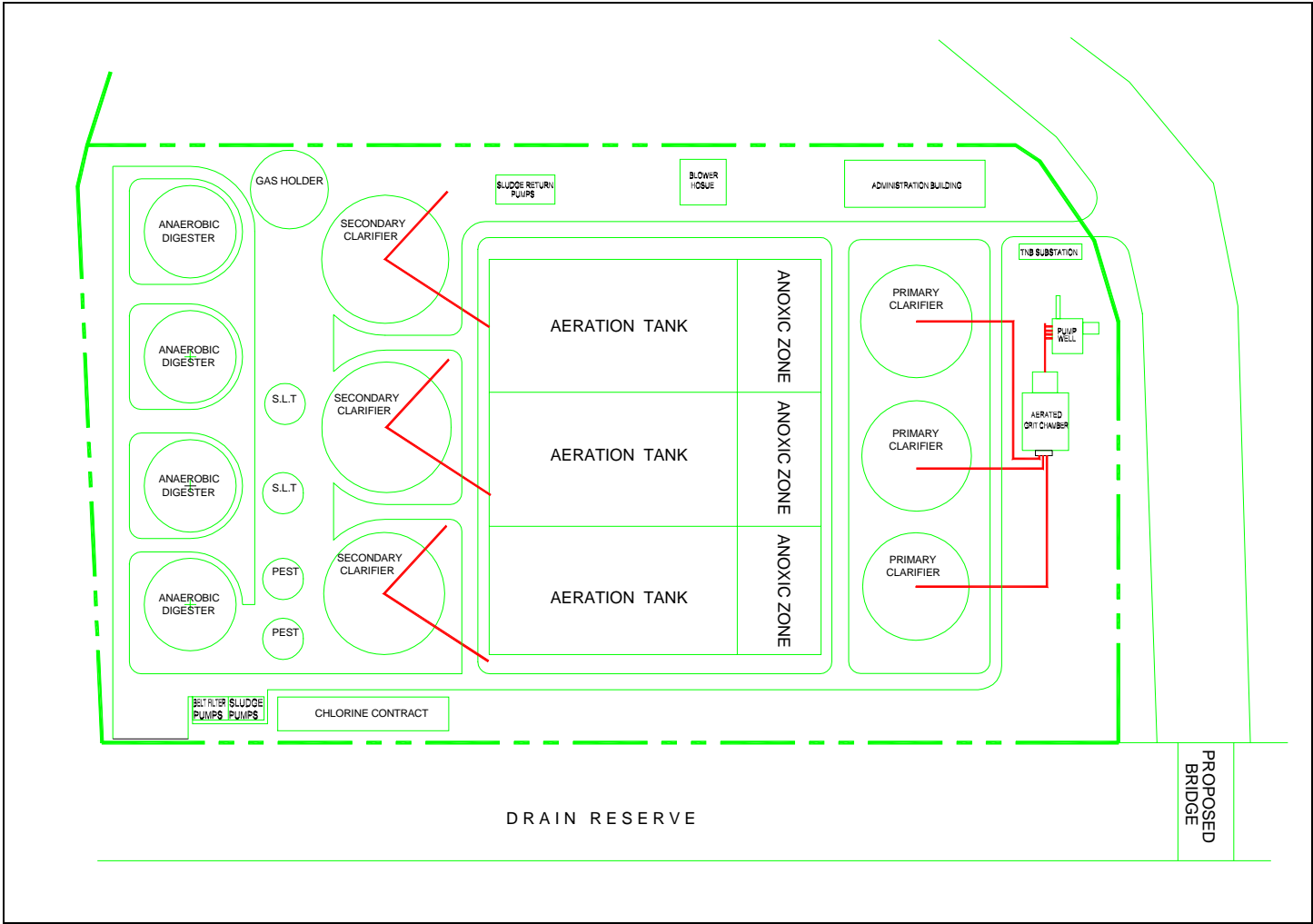

Figure 4.5 Layout of New Mechanised CSTP for Shah Alam Sewerage System

Table 4.2 Capacities of Current Unit Processes

Unit Process	Existing Design PE Capacity (thousands) (a)	Current PE Served (thousands)	Comments
Screenings ¹	15	8	Capacity available
Grit Removal ¹	15	8	Capacity available
Primary Sedimentation ¹	15	8	Capacity available
Trickling Filters	18	8	Capacity available
Humus Tanks ¹	7	8	Capacity available
Screenings ²	50	38	Capacity available
Grit Removal ²	80	38	Capacity available
Primary Sedimentation ²	36	38	Capacity exceeded
Aeration ²	50 ⁴	38	Capacity available
Secondary Sedimentation ²	30	38	Capacity exceeded
Secondary Sedimentation ³	40	-	In construction stage
Oxidation Pond	150	47	Capacity available
Bio-solid Digestion	46	47	Near capacity

Notes:

1. A works - Trickling filter process
 2. B works - Activated bio-solid process
 3. New clarifiers being constructed presently
 4. Capacity needs to be reassessed since aeration system has been upgraded
- (a) Assessed employing unit process design criteria published in the DGSS Developer Guidelines Volume 4

Characterise capacity of unit processes

For large plants or more advanced processes, specific analysis of its design and operational status will need to be assessed.

It is preferable if the plant can be described in terms of the actual size of unit processes it is made up of, for example as presented in *Table 4.3*. The treatment capacities can then be computed based on the design criteria actually employed (Refer *Table 4.4*). These derived capacities should be compared with capacities determined by employing equivalent criteria published by the Sewerage Services Department (Guidelines for Developer), and modified to account for the known condition of the plant.

Table 4.5 shows the typical reactor volume per PE in different treatment processes. If the capacity of a plant is not clear, the capacity can be roughly estimated on these volumes. For example, a CAS process plant has 3,000 m³ of reactor volume. This plant's capacity is calculated by dividing a reactor volume 3,000 m³ by 0.7 m³/PE. About 4,200 PE is estimated as the capacity of this plant.

Table 4.3 Details of Unit Processes Pertaining to a STP

Process Unit	Dimensions	Capacity
Imhoff Tank	2 compartments each 2.44m x 8.53m	41.6 m ²
Primary Sedimentation	Old - 2 tanks each 7.62m x 7.62m New - 1 tank 12.8m diameter	1160 m ² 128.7 m ²
Trickling Filters	Old - 2 @ 24.4m diameter, 2.0m depth (estimate) New - 1 @ 25.9m diameter, 2.44m depth	933.6 m ² 1,870.0 m ³ 526.8 m ² 1,290.0 m ³
Humus Tanks	Old - 1 tank 6.48m x 6.48 New - 1 tank 11.0m diameter.	42.0 m ² 95.0m ²
Chlorination	Depth 1.5m, Area 44.1m ²	44.1m ² 66.1m ³
Digesters	Primary - 1 tank 9.14m diameter, 5.87 m SWD Secondary - 2 tanks 7.92m diameter, 4.74m SWD	385.5m ³ 467.0m ³
Drying Beds	Old - 6 @ 62.0m ² each New - 12 @ 81.5m ² each	372.0m ² 978.0m ²

Table 4.4 Existing Capacities of Unit Processes Pertaining to a STP

Unit	Design Basis	Loading
Imhoff Tank (m ³ /m ² /day at ADWF)	10	36.0
Primary Sedimentation (m ³ /m ² /day at ADWF)	10	13.0
Trickling Filters (g BOD/m ³ /day at ADWF)	200	126a
Humus Tanks (m ³ /m ² /day at ADWF)	20	26.8
Chlorination Tank (min. detention at ADWF)	30	32
Bio-solid Digesters (days detention)		
Primary	15	13.8b
Secondary	15	16.7b
Bio-solid Drying Beds (PE/m ³)		
Old Works	10	7.4
New Works	10	

Notes:

a. Assumes 30 per cent BOD₅ removal in primary treatment

b. Manual bio-solid withdrawal

Unit processes which are not able to cope with the current influent sewage flow rates and pollutant load should be noted for future upgrading or augmentation, if it is decided that the treatment plant remains in operation.

Table 4.5 Typical Reactor Volume per PE in Mechanised Treatment

Treatment Process	Reactor Volume	Calculations
Conventional Activated Bio-solid System (CAS)	0.7 m ³ /PE	14 hr (HRT)/24 × 225 × 3.9(peak factor) ÷ 1000 × 1.2(safety factor)
Extended Aeration System (EA)	1.0 m ³ /PE	21 hr (HRT)/24 × 225 × 3.9(peak factor) ÷ 1000 × 1.2(safety factor)
Rotating Biological Contractors (RBC)	0.03 m ³ /PE	2 hr (HRT)/24 × 225 ÷ 1000 × 1.2(safety factor)
Trickling Filters (High Rate Filter)	0.05 m ² /PE	225 × 3.9(peak factor) × 1.2(safety factor) ÷ 1000 ÷ 25 m ³ /d/m ²
Sequencing Batch Reactors (SBR)	0.3 m ³ /PE	21 hr (HRT)/24 × 225 ÷ 1000 × 1.2(safety factor)

Notes:

- Design criteria such as hydraulic retention times and an organic loading is quoted from Vol.4 under revising.
- Peak factor is calculated on 5,000 PE. (3.9=4.7 × (5,000/1,000)^{0.11})

4.6 Bio-solid Processing

Both on-site and off-site STPs, the former represented by Septic Tanks and small package treatment plants, produce bio-solids which need separate processing to render them suitable for discharge to the environment.

It is therefore necessary to review the management of sewage bio-solids generated by the Catchment; encompassing their collection, conveyance, treatment and disposal. From such a review an assessment should be made on the suitability and environmental compatibility of current management measures being adopted.

If there is in existence any bio-solid treatment facilities (STFs) which are independent of an STP, their unit processes should be inventorised in the same manner as that described for a Sewage Treatment Plant.

The major bio-solid treatment processes are shown in *Figure 4.6*.

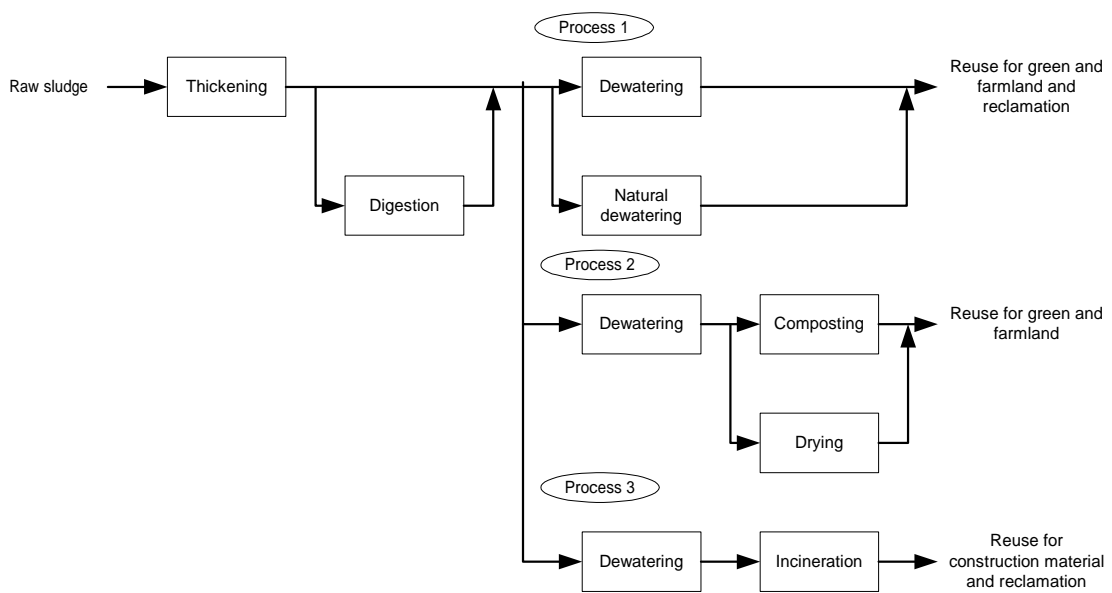

Figure 4.6 Typical Flow of Bio-solid Treatment Processes

Process 1 is considered when dewatered bio-solid is used for greens and farmland or used in reclamation works. In this case, the process to reuse bio-solid for greens and farmland is inexpensive and simple with respect to final disposal, but poses safety risks from the bacteriological aspect. It would be desirable to stabilize the bio-solid prior to disposal by applying digestion. There are also considerations to be made for odour and conveyance, and requires careful study on the impacts on the surrounding environment. Especially when natural dewatering systems are selected, risks and impacts must be mitigated or carefully managed.

Process 2 is considered when bio-solid is used for greens and farmland as fertilizer after further processing of dewatered bio-solid. The processed bio-solid is more favourable in quality for application on greens and farmland, since through composting or mechanical drying, bio-solid is converted into dry bio-solid which is safer and easier to handle.

Process 3 is considered when bio-solid is used as construction material in the form of ash or slug or for reclamation by incinerating dewatered bio-solid. In particular, bio-solid has been reused as construction material, as raw material for cement, soil improvement agent, road-base material, light aggregate, brick, tile, permeable concrete block, concrete aggregate, clay pipe, etc. Bio-solid can also be used for reclamation for both marine and inland applications.

Characteristics on each bio-solid treatment are summarized in *Table 4.6* and *4.7*. Usually on the medium–large size bio-solid production near residential area dewatering is suitable from cost, odour, and land space. On small size near rural area composting is suitable because of availability of large space and odour concern. Incineration should be considered in the case of limited disposal area and treatment of large amount of bio-solid which is more than 20t/day as dewatered bio-solid.

In the developing the bio-solid treatment process, the combination of unit processes is decided on, taking into account: (1) design bio-solid flow and bio-solid property, (2) stabilization requirements for reuse and disposal, (3) location of the facilities and disposal areas, and (4) environmental conditions and requirements.

For each unit process, there are several systems and equipment types, and therefore a variety of combinations has to be considered. Therefore, it is necessary to make a comprehensive study and decide on the appropriate bio-solid treatment processes, based on a comprehensive evaluation of the construction cost, operation and maintenance (O&M) cost, O&M complexity, etc. by proposed combination alternative.

The bio-solid volume generated is expected to increase in future, accompanied with the progress of sewerage provision. In such a situation that the surrounding conditions involved in the bio-solid treatment and disposal have been changing, the comprehensive and systematic framework is required to promote the efficient treatment and utilization of sewage bio-solid.

Table 4.6 Characteristics on Bio-solid Treatment Process

Bio-solid Treatment Process	Advantageous	Disadvantageous
Dewatering	<ul style="list-style-type: none"> · High reduction of bio-solid volume. · No odour and noise because of closed system. · Small space for processing. 	<ul style="list-style-type: none"> · Relatively high cost because of high electric consumption processes. · Need for final disposal sites. · Need for the treatment of filtered water.
Composting	<ul style="list-style-type: none"> · Reuse of bio-solid as resources. · Hygienically stable because heat occurring in process kills bacteria. · Relatively low cost treatment comparing with incineration and dewatering. 	<ul style="list-style-type: none"> · Need for large space for processing. · Confirmation on the consumption volume and the number of consumers for sustainable consumptions. · Odour problems because a system is an open-system. · Bio-solid containing large heavy metals is not applicable because of health concerns.
Drying	<ul style="list-style-type: none"> · Natural drying is not an expensive treatment. · Natural drying is easy maintenance. · Small space for a mechanical drying. 	<ul style="list-style-type: none"> · Need for large space for natural drying. · Fly and odour problems with natural drying. · Dried bio-solid by natural drying is hygienically unstable. · Mechanical drying is a high cost treatment because of heating fuel and equipment. · Need Odour treatment equipments in mechanical drying. · Difficulty on maintenance in mechanical drying.
Incineration	<ul style="list-style-type: none"> · Effectively reduce volume of bio-solid. · Possible to control odour and noise because of closed system. · Effective for a large amount of bio-solid treatment (more than 20t as dewatered bio-solid). 	<ul style="list-style-type: none"> · High treatment costs because of burning fuel and equipments. · Difficulty on maintenance for prevention of air pollution. · Need for the treatment of dewatered water. · Need for final disposal sites.

Table 4.7 Typical Characteristics on Bio-solid Treatment Process

Contents	Dewatering	Composting	Drying (Mechanical)	Incineration
Cost	Medium	Not expensive	Expensive	Expensive
Land Space	Small	Large	Small-Medium	Small-Medium
Maintenance Skill	Low-Medium	Low	High	High
Environmental Concerns	Filtered Water	Odour	Odour	Air Pollution
Treatment Capacity	Medium-Large	Small	Medium-Large	Large

4.7 Disposal Trends

The quality of effluent discharged by existing STPs should be reviewed in terms of complying with discharge standards established by the Department of Environment, Malaysia (DOE). This would provide an indication of their reliability and operating efficiency. The performance of existing STPs are to be considered when evolving a sewerage catchment plan; i.e. whether they can be retained, upgraded or should be replaced or abandoned.

Effluent standards established by the DOE for treated sewage discharges from STPs are presented under two categories, i.e. *Standard A and Standard B*. In general conformance to Standard A is required if treated effluents are discharged to receiving waters which will be used for public water supply purposes, otherwise Standard B criteria shall prevail. It is important to notice that *Standards A and B* are both *absolute* standards. The 50 percentile, or average, pollutant concentrations released by STPs will need to be at least half of the values presented in *Table 4.8* below:

Table 4.8 Effluent Discharge Standards to Malaysia

Parameter (mg/l unless otherwise state)	Effluent Discharge to Rivers / Stream				Effluent Discharge to * Stagnant Water Bodies			
	Standard A		Standard B		Standard A		Standard B	
	Absolute	Design	Absolute	Design	Absolute	Design	Absolute	Design
BOD ₅	20	10	50	20	20	10	50	20
SS	50	20	100	40	50	20	100	40
COD	120	60	200	100	120	60	200	100
AMN	10	5	20	10	5	2	5	2
Nitrate Nitrogen	20	10	50	20	10	5	10	5
Total Phosphorus	N/A	N/A	N/A	N/A	5	2	10	5
O&G	5	2	10	5	5	2	10	5

Notes:

NA = Not Applicable

* Stagnant Water Bodies refer to enclosed water bodies such as lakes, ponds and slow moving watercourses where dead zone occur

Processes for bio-solid management needed

Similarly processed bio-solid will have to be disposed to the environment. Currently there are no uniform bio-solid disposal guidelines in Malaysia although these are being developed. The regulation can be expected to follow US and European guidelines regulating toxins, pathogens and degree of stabilisation. The DGSS and Sewerage Concessionaire should be consulted on the preferred manner by which processed bio-solids should be ultimately disposed; with emphasis being placed on reutilisation (i.e. for agricultural, horticultural and soil reclamation purposes).

Presently there are two types of sludge which are to be disposed

(1) dry bio-solid and

(2) wet sludge.

Figure 4.7 shows the final disposal types based on the characteristics of sludge. Disposal types are basically decided based on the moisture content of sludge. A stable and well dewatered sludge such as dry bio-solid can be used as a resource after composting or is disposed in a least controlled landfill. Wet sludge is should be disposed in a controlled landfill.

The characteristics of final disposal types are shown in *Table 4.9* and schematic drawings are shown in Figure 4.8.

A least controlled landfill is used for dry bio-solids which do not produce lechate. This consists of three units, disposal site, permeated water sampling well, and groundwater monitoring well. These two wells are set for confirming no pollution due to leachate from waste and substantiated through monitoring water quality.

A controlled landfill is used for disposing wet sludge which produces lechate. This is a common disposal method for small amount of sludge. A controlled landfill consists of three units, disposal site, groundwater monitoring well, and leachate treatment (if necessary). Groundwater monitoring wells are important to confirm that no groundwater pollution is caused by lechate from bio-solid and substantiated through monitoring water quality of groundwater. If lechate quality is over the effluent discharge standard, lechate should be collected and treated.

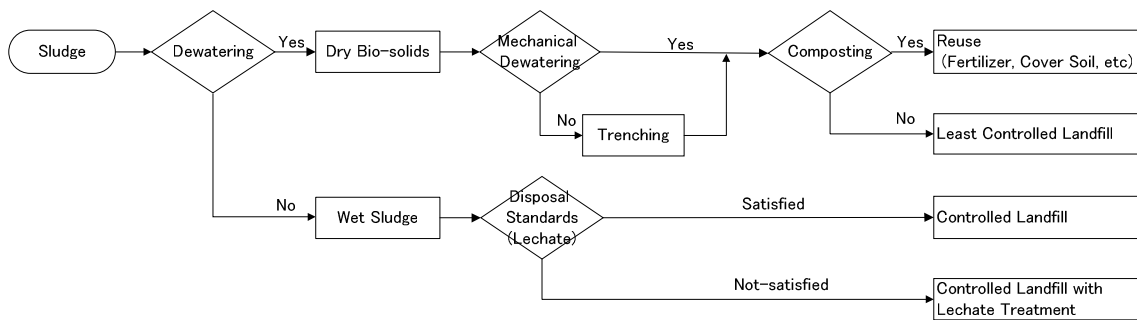

Figure 4.7 Final Disposal Types based on the characteristics of Bio-solids

Table 4.9 Characteristics of Final Disposal Type

Disposal Type	Disposed Bio-solid Type	Characteristics
Least controlled landfill	Dry Bio-solid	This consists of three units, disposal site, permeated water sampling well, and groundwater monitoring well. These two wells are set for confirming no leachate from waste by monitoring water quality. Most types of bio-solid in central sludge treatment facilities and large STPs are disposed in this type because dewatering necessary to reduce the volume of bio-solid. It is necessary to monitor the groundwater quality for checking the effect of disposing dry bio-solid on groundwater.
Controlled landfill	Wet sludge	Controlled landfill is used for disposing wet bio-solids which produce leachate. This consists of three units, disposal site, groundwater monitoring well, and leachate treatment (If necessary). When the amount of sludge is small, the treatment of sludge is not centralized, and lechate is not non-hazardous, this type could be suitable because dewatering facilities is expensive for samll amount of sludge. If lechate contains chemicals exceeding the effluent discharge standards for protecting water environment around disposal sites.

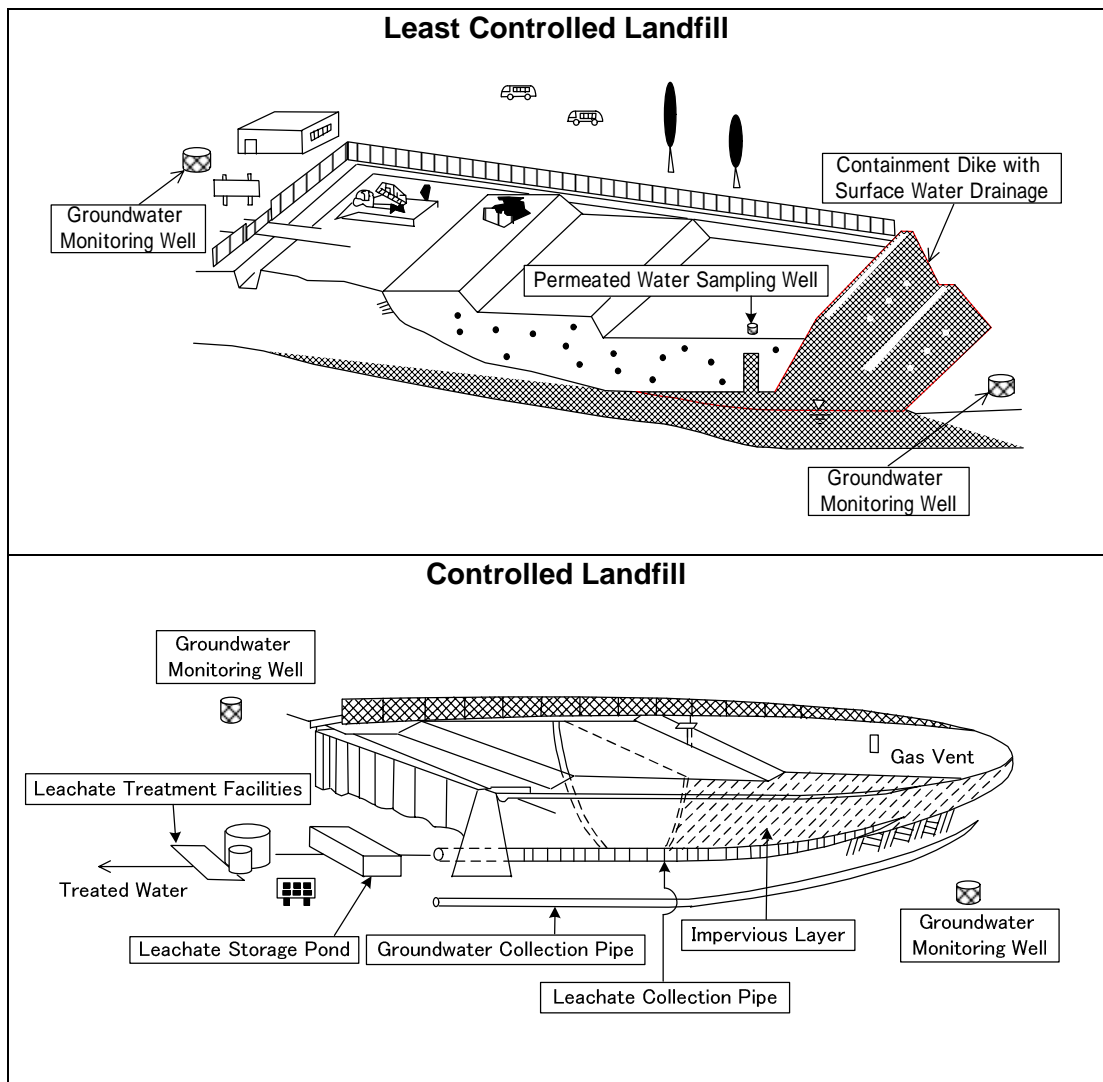

Figure 4.8 Final Disposal Types (Example)

SECTION 5

Estimation of Sewage Flows, Pollutant Loads and Bio-solid Generation Rates

5.1 Introduction

This Chapter describes methodologies for estimating sewage flow rates, mass pollutant conveyance rates, and bio-solid generation rates over a selected planning period.

Influence of Sewage Flows in Catchment Planning

Estimations of sewage flow and associated pollutant loading and bio-solid generation rates are an important facet of Sewerage Catchment Planning, as they dictate the sizing of collection and conveyance systems, and the determination of treatment plant capacities and their spatial requirements.

This Chapter focuses on defining the different forms of sewage flows which have to be considered, and the manner by which they are to be quantified at different time intervals over a selected planning period. Quantification of pollutant mass rates conveyed in sewage flows, and resulting bio-solid generation rates at treatment plants, at different time intervals over a planning period, are also described.

5.2 Sewage Flows

Three Forms

There are three main forms of sewage flows that require consideration in Sewerage Catchment Planning; these are the *Average Dry Weather Flows (ADWF)*, the *Average Wet Weather Flows (AWWF)* and the *Peak Wet Weather Flows (PWWF)*. Their methods of estimation are summarily described herewith, and further elaborated in *Appendix B*.

Average Dry Weather Flows

Sewage flows, generated at source, and discharged directly into sewers without admixture with any other form of liquid flow (e.g. groundwater, or storm waters), are termed as *Average Dry Weather Flows (ADWF)*. This form of sewage flow is computed by multiplying the total contributing Population Equivalent estimate by the per capita sewage flow generation rate (i.e. 225 litres/day) [Refer to *Appendix B* for clarification on terminologies].

Average Wet Weather Flow (AWWF)

When an amount of extraneous flows are added to the estimated ADWF, the resulting flow volume is termed the *Average Wet Weather Flow (AWWF)*. AWWFs are important in the sizing of certain treatment plant process units (e.g. activated bio-solid process units). Methods for computing extraneous flows are described in *Appendix B*.

Peak Wet Weather Flow (PWWF)

Peak Wet Weather Flow (PWWF) rates at any point within a sewer network system are determined by multiplying the computed ADWFs that are associated with an estimated total Population Equivalent Count connected to the system upstream of the point of flow estimation, by a derived Peak Flow Factor (PFF). The latter is a function of the estimated connected Population Equivalent served at the point of flow contention (Refer to *Appendix B* for background information on PWWF's and the PFF). It is to be noted that the value of PWWFs can vary throughout a sewer network system, being dependent basically on the magnitude of the contributing Population Equivalents being served. Estimates of PWWFs are required not only for the sizing of sewer pipelines, but also for sizing of intermediate pump stations and for certain treatment plant process units (e.g. sedimentation tanks).

5.3 Sewage Pollutants

Sewage in its original form contains a number of undesirable substances, or what is termed as pollutants. The common forms of pollutants present in sewage flows are summarised in *Appendix B (Table B.2)*.

For sewerage catchment planning purposes the important pollutants of interest include the Five-Day Biochemical Oxygen Demand Index, or BOD₅; and the Total Suspended Solids Index, or TSS. Other pollutant indices such as the Chemical Oxygen Demand (COD) and Total Nitrogen Content may also be considered in sizing particular treatment processes.

Sizing of certain treatment plant process units is dependent on the amount of BOD₅ and TSS matter that has to be handled. Furthermore the BOD₅ and TSS parameters are the main referral pollutants employed in determining the treatment efficiency of STPs, and their capability in meeting effluent discharge standards.

The amount of BOD₅ and TSS matter discharged by a single person living in a dwelling unit connected to a sewerage system has been evaluated. The per capita unit rates of generation of these two pollutants are described in *Appendix B*.

Therefore, based on predictions of the total amount of sewage flows that have to be handled by a Sewage Treatment Plant (STP) [which is generally expressed in terms of contributing PEs], an estimate can then be made on the amount of BOD₅ and TSS matter that has to be catered for by the treatment system. This is performed by multiplying the estimated PE count to be served by the plant by the corresponding unit rates of generation of BOD₅ and TSS as recommended by the Malaysian Standard MS 1228 Code of Practice for Design and Installation of Sewerage Systems (Refer to *Appendix B*).

5.4 Estimation of Sewage Flows

Factors Contributing to Estimation of Sewage Flow

Estimations of Average Dry Weather (sewage) Flows generated by a specific contributing area within a Catchment, or by the Catchment as a whole, at different time intervals over a planning period are governed by predictions of current and potential future Population Equivalent (PE) counts associated with such areas. In most cases populations resident permanently within a Catchment contribute to a major portion of the total PE count. On the other hand commercial, institutional, industrial and other establishments, cumulatively, do not generally contribute as much. Hence it is important to estimate as accurately as possible population levels that are resident within a catchment area at particular time intervals over a planning period; especially within the foreseeable future.

Estimates of total Population Equivalent (PE) counts associated with a specific area at a selected time interval are derived by first of all carrying out an in-depth inventory of (a) the total resident population level (or number of individual residential dwelling units occupied); (b) the amount of useable floor space area associated with commercial offices, low rise shop houses and institutional buildings; (c) the number of workers employed in industrial establishments; (d) the number of schools and associated pupil population; (e) the number of hospital beds; and (f) the type and number of miscellaneous establishments (e.g. petrol stations, religious institutions, etc.) located within a targeted area.

Estimating Baseline or Existing PE Counts

It is not an insurmountable task to estimate the number of existing residential dwellings and other establishments which release sewage flows, since most, if not all, Local Authorities would maintain a comprehensive inventory of each type of establishment, and their respective locations. In addition land use profiles over local authority areas are also available and can be obtained from the District Office/Municipal Office, or from the Town and Country Planning Departments. Land use profiles provide valuable information on population density distributions, and on the spatial distribution of residential, commercial, industrial and institutional developments. Such information is helpful in deducing probable spatial distribution and intensity of sewage flow generation over a targeted Catchment Area.

Specific layout details of housing estates, industrial areas and commercial areas are also available in the form of scaled drawings from which specific information such as the number of individual dwellings, industrial lots and commercial and shop house plots can be enumerated. Certain Local Authorities also maintain comprehensive listing on existing number of residential and commercial buildings. It is possible that other Public Agencies such as Waterworks Department, TNB, Postal Department and Ministry of Health (MOH) will have records of existing buildings within a local area. The MOH would have comprehensive listing of kampong dwellings. Such information should nevertheless be verified by conducting site reconnaissance visits.

Population Statistics

The residential population level of a Catchment Area may also be estimated based on published statistical population estimates pertaining to a locality which coincides with, or encompasses boundaries of the Catchment Area. National Census based population counts, displayed in terms of Enumeration Blocks covering the Catchment Area, can also be used as a basis to predict current population levels. The Planner needs to further distribute and refine these gross population estimates to suit smaller unit areas representing service areas of specific stretches of a sewer pipe line or a STP.

Information Portrayal

The information so garnered should be documented preferably on revenue sheets of a suitable scale where individual lots are clearly demarcated. The ultimate goal of this exercise would be to display the derived information as spatial profiles of land use development, building types and sewage generation rates (in terms of PE counts).

Estimation of Future PE Counts

The basic aim of any planning exercise is to attempt to anticipate likely trends in population and physical development changes within a Catchment Area; such as residential and transient (visitor) population level increases or decreases over a Planning Period, and landuse changes and growth patterns of commercial, industrial and institutional establishments within the same time frame. Any form of projection should be based on reliable, concrete, evidence or supporting data. *Wherever possible recourse should be made to employ population, commercial and industrial growth projections that are employed by Local Authorities to plan out infrastructural works within their area of jurisdiction.*

Potential Sources of Information

An approach that can be adopted in predicting future PE counts would involve carrying out the following tasks:

- ◆ Reviewing population projections that have been carried out by Government or private agencies for State, Municipal or Local Authority areas, and translating such information to suit a targeted Catchment Area.
- ◆ Sourcing data from Local Authorities and State Planning Authority that have inventorised establishments into categories such as those under construction, approved with Development Order or with planning approval, and those submitted for planning approval. In most cases the information provided specifies the particular lot on which an existing or proposed development is located.
- ◆ Building units under construction, or those approved with Development Order/Building Plan may be considered to be fully occupied within a ten year period. Others submitted for planning approval may be considered to be implemented and occupied within a twenty year period.

- ◆ Sourcing information from Local Authorities, State Economic Development Corporations, State Economic Planning Units and from Indah Water Konsortium on comprehensive forms of development that are being constructed or are in the planning stage (e.g. housing estates, commercial and institutional centres, industrial estates, etc.); including particulars concerning the number of various types of buildings to be erected and the staging of their implementation.
- ◆ Liaising with Contractors and Developers to gain up-dated information on establishments that are being built or expected to be implemented in the foreseeable future.

Population Growth Assessment

It is important that the Planner assesses the reliability of published *population projections* for an area, especially if they were carried out more than five years ago. Predicted population growth rates for previous years should be verified against latest population census figures, and/or with observed physical development trends that have occurred since the projections were made. Predicted growth rates documented for future years should be assessed for their accuracy by reviewing probable development trends and anticipated land use changes that could occur based on updated development policies, and committed plans for development in an area.

An accurate assessment of land use and population growth within the catchment area is essential, in determining sewage flows in the sewerage system. The sources of information for estimating the contributing population equivalent are

- ◆ Population census, and/or
- ◆ Structure Plans and Land-Use Plans of Local Authorities

The Population Equivalent conversion factors shall be obtained from the MS 1228. These usually form the basis, for estimating the contributing population equivalent to the sewerage system, for the determination of sewage flow, for the sizing of sewers, pump stations, treatment plants and land area required for the plant. This shall include changes in land use and economic development trends, as well as contributing flow from approved, pre-treated trade effluents.

For example if future population growth within a Catchment Area is expected to be slow, and if no new planned or redevelopment plans are expected to materialise that will generate new job opportunities and implementation of housing schemes, future population growth can be estimated from simple extrapolation of historical trends. For example population trends of a small catchment with a population of 9,000 PE are summarised in *Table 5.1*.

Table 5.1 Population Growth, No Development

Year	Population	% Increase over 5 years	Predicted Population
1971	8475		
1976	8632	1.9	
1981	8919	3.3	
1986	9144	2.5	
1991	9363	2.4	
1996		2.5	9597
2001		2.5	9837

Over the period 1971 to 1991, the average growth rate was approximately 2.5%. Hence, one option is to assume a similar growth rate for the rest of the decade.

Examine Factors Dictating Population Growth

For catchments which anticipate significant changes in land use, or major redevelopment or development trends, more detailed analysis will be required. Potential changes can usually be verified by holding discussions with relevant Government and Private Agencies. An example of factors considered in ascertaining future population growth within an urbanised area is presented in *Appendix B*.

There are a number of empirical approaches which can be adopted to predict future population levels and these are summarised in *Appendix D*. The choice of an appropriate approach should be based on an assessment of the potential physical growth of the area, its physical size, its future land use profile and capacity to sustain higher levels of population (i.e. sustainable maximum population density).

Commercial Floor Space Contribution to Total PE Counts

In the core areas of heavily built-up urban areas, commercial establishments can contribute towards a significant portion of the total PE count (as for example in the central commercial areas of Kuala Lumpur). Hence in such circumstances a concerted effort should be made to assess future growth of commercial floor space area and their corresponding PE contribution. Future commercial floor space area can be ascertained by

- ◆ Reviewing documented commercial floor space growth rates experienced in the past (refer to *Table 5.2*), and making a judgmental decision on future growth rates based on known and assumed economic growth scenarios and changes in the form of commercial floor space that shall be built in the future.

For example future floor space area for Shop House Developments (SHD) could remain stagnant, as old two storey SHD are replaced with new four storey SHD.

Table 5.2 Commercial Floor Space, Pantai Sewerage Catchment

Year	Floor Space, Million Square Metres					
	Comprehensive Development			Shop House Development		
	Business	Residential	Hotel	Business	Residential	Hotel
1983	2.25	0.13	0.31	1.33	0.83	0.06
1993	2.49	0.16	0.38	1.33	0.83	0.06
1994	4.77	0.31	0.52	1.50	0.70	0.04
1995	5.35	0.35	0.55	1.55	0.65	0.03

- ◆ Reviewing records maintained by the Local Authorities on commercial floor space areas under construction, those approved with Development Order, those given planning approvals, and those awaiting planning approvals.

Other Contributing PE Sources

Similar principles can be applied to determine appropriate growth rates for other types of sewage generating establishments, such as Industrial and Institutional establishments (including schools, Universities and Colleges), and Hotels.

Total Predicted PE Counts and Conversion to ADWFs

The total PE count contributed by residential, commercial, institutional, industrial and recreational developments located throughout the Catchment at specific milestone years throughout a planning period can then be ascertained by summing up the individual contributing PE counts. The corresponding ADWF rates are calculated by multiplying the total PE count for a bench mark year by the per capita sewage flow rate of 225 litres/day. The resulting distribution in ADWFs generated by an entire Catchment over the Planning Period can then be summarised as follows:

Table 5.3 Cumulative ADWFs at Various Bench Mark Years (Pantai Sewerage Catchment)

Land Use Contribution	1995	2000	2005	2010	2015
	cu.m/day (x 1000)				
Residential	71.25	113.63	140.15	175.00	194.70
Commercial	45.20	76.60	107.75	123.55	136.00
Institutional	16.60	19.80	21.30	25.60	29.10

Hotels	4.10	10.75	14.00	18.50	19.90
Totals	137.15	220.80	283.20	342.65	379.70

The same methodology is also applied in estimating temporal estimates of ADWFs that are generated by *specific sub-zones* within a catchment whose boundaries are defined either by the service areas of individual STPs (existing or future), areas served by different forms of on-site treatment systems (Refer to *Figure 4.1*), areas served by a particular reach of a sewer network system, or by topographical divides, drainage obstacles, or major thoroughfares.

Develop High and Low Projections

For many catchments it is appropriate to consider a range of scenarios to estimate future Population Equivalent Counts and hence ADWFs. The most convenient method is to estimate high and low PE trends. The actual planning figure is selected within this envelope but providing sufficient flexibility within the selected sewerage system to manage the anticipated range. The need to carry out such an analysis is more important for larger catchments which are expected to have significant developments or variations in land use. Other types of catchments which tend to require more detailed analysis are those where the capacity of the existing sewerage system is expected to be exceeded. For example, where there is little land area available at the existing sewage treatment plant for future expansion, or the size of existing collector and trunk sewers precludes connection of additional average dry weather sewage flows.

To develop such an envelope of PE Counts a detailed understanding of the factors which influence the level of catchment populations and economic growth (encompassing commercial and industrial growth) is required. Each catchment will have different sets of factors, however they can be grouped and each group will need to be examined for its impacts on the catchment.

For each catchment a range of relevant assumptions can then be made to set the upper and lower total population equivalent count bands. The actual figures selected will probably be in the middle of these two bands, but with some knowledge of the potential to increase or decrease the size and capacity of the sewerage system to serve various land uses.

Focus on Short and Medium Term Projections

Sewerage Catchment Planning extends over a considerable time frame (at least 20 years). Hence the reliability of PE Counts projected for the later years of a Planning Period become questionable, as the underlying assumptions used in projecting PE counts may also be subject to uncertainties.

In any case one essential goal of a Sewerage Catchment Plan is to ascertain existing sewerage system deficiencies, and to plan for sewerage system extensions/upgrading to meet the short and medium term needs of a Catchment; say within the next ten years. For this first priority action plan, reliable PE counts can be projected based on an inventory of existing, and under construction,

establishments, and those which have obtained a development order. It can be safely assumed that such establishments shall be present in the next 10 years or so. It is therefore justifiable to focus intently on estimating PE counts likely to be generated in the short to medium terms and to present the findings in the following manner.

Table 5.4 Projects from Existing and New Developments up to Year 2000 Within Pulau Meranti Catchment

	Development Type	Development Status			Expected Completion Date	PE Count	Comments
		E	UC	PA			
Green Delight Hydroponic, Pulau Meranti	Factory	3				10	
Bandar Bukit Puchong (Phase 1)	Mixed			3	1999	14033	
Taman Inai Perkasa (Phase 1)	Mixed			3	1999	8500	Extended Aeration
Taman Mas Sepang (Phase 1)	Mixed		3		1998	6180	Extended Aeration
Taman Meranti Jaya (Phase 1)	Mixed	3	3		1999	10520	Extended Aeration
Taman Putra Perdana (Phase 1)	Mixed		3		1999	22500	Oxidation Ditch
Public Toilet, Bandar Baru Salak Tinggi	Public Toilet	3				32	
Taman Desa Air Hitam	Residential	3				2315	
Pulau Meranti National School, Puchong	School	3				68	
Pulau Meranti National School	School	3				46	
Kg. Pulau Mernati	Residential	3				1070	
Tenaga Pencawang, Air Hitam	Factory	3				20	
Cumulative Total PE for Existing	1997 = 8121					8121	
Cumulative Total PE for Development Under Construction	1997 = - 1998 = 6180 1999 = 28460					34640	
Cumulative Total PE for Planning Approved	1997 = - 1998 = - 1999 = 22533					22533	
Cumulative Total PE for Existing and New Development up to Year 2000						65294	

Note: E = Existing
UC = Under Construction
PA = Planning Approved

Actual Sewage Flows Channelled to Sewer Systems

It is usually assumed that all sewage flows generated within an establishment are channelled to a sewer system. This may not be the case especially for older establishments, say constructed prior to 1980's, where sullage waters (i.e. from wash basins located in toilets and kitchen areas) are discharged to surface drains. Hence in Catchments housing older establishments some alternation of PE counts may be necessary to reflect a true rate of sewage discharge to the sewer system, especially during the initial periods of the Catchment Plan. Allowances should nevertheless be made in the overall Planning Period for discharge of all forms of sewage as older building units are replaced by new units and as replumbing exercises are carried out to ensure that all sewage discharges from building units are directed to the nearest sewer.

Projections of Other Forms of Sewage Flows

Once the Average Dry Weather Flows (ADWFs) have been predicted corresponding estimates of Average Wet Weather Flows and Peak Wet Weather Flows can be computed for the same milestone years throughout a Planning Period.

Average Wet Weather Flows (AWWF) are estimated by adding computed extraneous flow contributions to the ADWF.

Peak Wet Weather Flows can be computed at any point along a sewer line by first of all demarcating the contributing catchment area and then estimating the contributing total PE count. This is followed by estimating the ADWF and PFF and multiplying these two factors to arrive at the PWWF.

5.5 Pollutant Load Projections

Population Equivalent (PE) counts can be translated to pollutant mass loads using standard conversion factors as described in *Appendix B*. Conversion factors may change with time dictated by upliftment of social standards (Refer *Appendix B*). The sewerage catchment planner may employ different conversion factors over a 20 year planning period if there is a justification to do so.

The example of inflow pollution load in each sub-catchment is shown in *Table 5.5*. Inflow BOD is calculated based on a design BOD and a per capita sewage generation rate of 225 L/day.

Table 5.5 Inflow BOD Pollution Load

Sub-Catchment	Ultimate PE	Inflow
		BOD kg/d
1. C1	146,900	8,263
2. C2	117,100	6,586
3. C3	15,500	871
4. C4	11,900	669
5. C5	11,000	618
6. C6	40,000	2,250
7. C7	12,000	675

The pollution load from effluent discharged by public STPs and septic tanks are based on the following assumptions.

- Effluent is changed by the approval year of STP (Table 5.6).
- Each imhoff tank and septic tank have 5 PE.

Table 5.6 BOD Effluent for the Estimation of Pollution Load(Based on DOE Proposal)

Approval Year	Before 1999						After 1999	
	Septic Tank	Imhoff Tank	Oxidation Pond	Aerated Lagoon	Mechanical Plant		Std. A	Std. B
					Std. A	Std. B		
BOD ₅ (mg/L)	200	175	120	100	60	80	20	50

Table 5.7 is an example of Summary of discharged pollution load based on Table 5.6.

Table 5.7 Sewerage System Status: Pollution Load

	BOD kg/d	
	Present	Future
	2007	2027
Public STPs	200	250
Private STPs	5	5
Septic Tank	100	0
Pourflush	20	0

Assuming that the difference between the downstream water quality and the upstream water quality is the pollution load produced in the river basin, pollution load from non-domestic sources can be evaluated. In this case when non-domestic pollution load is assessed to be more than the domestic pollution load, it is clear that pollution from non-domestic sources has a bigger impact on water quality than domestic sources, and this should be given due consideration in the planning exercise.

Table 5.8 shows the example of calculation on non-domestic pollution loads.

Table 5.8 Example of Calculating Non-Domestic Pollution Load

Contents		
Downstream Water Quality	2.0 mg/L as BOD	
Downstream Water flow	412,500 m ³ /d	
Down stream Pollution Load	825 kg/d	= Water Quality × Flow
Upstream Water Quality	1.0 mg/L as BOD	
Upstream Water flow	200,000 M ³ /d	
Upstream Pollution Load	200 kg/d	= Water Quality × Flow
Difference in Pollution Load	625 kg/d	= Downstream-Upstream
Domestic Load	325 kg/d	
Public STP	200 kg/d	
Private STP	5 kg/d	
IST	100 kg/d	
Pourflush	20 kg/d	
Non-Domestic Pollution load	300 kg/d	= Downstream-Upstream
		- Domestic

5.6 Sewage Bio-solid Quantifications

Bio-solid Variations

The quantity and quality of bio-solid produced by different types of sewage treatment plant can vary appreciably. Hence bio-solid releases from STPs should be assessed separately in terms of their generation, need for further processing and mode of final disposal (Refer to *Appendix B*).

There can be variations in the bio-solid mass produced, the quality of bio-solid produced (in terms of its organic stability), and in the moisture content of bio-solids that requires final disposal.

Mass Generation Rates

The bio-solid generation rate depends on the sewage treatment process. Table 5.9 shows the bio-solid generation rate for the different treatment systems.

Based on this bio-solid generation rate, Table 5.10 and 5.11 show the typical bio-solid production per PE. In Table 5.10 (up to 2000 PE), it is assumed that an Imhoff system is in place, raw bio-solid has 1.0% solid contents, and dewatered bio-solid has 20% solid contents. In Table 5.11 (2000 PE and more), a conventional activated bio-solid plant is assumed. For this system, raw bio-solid is assumed to have 1.0% solid contents, and for dewatered bio-solid, 20% solid contents.

Table 5.9 Bio-solid Generation Rate

Treatment System	Unit Generation Rates	Comments
Primary Bio-solid		
Primary Clarifier	0.5 kg bio-solid/kg solids input	Based on continuous bio-solid withdrawal
Imhoff Tank	0.15 kg bio-solid/kg SS input	Based on average 6 month desludging period
Secondary Bio-solid		
Conventional Activated Bio-solid System	0.8 to 1.0 kg bio-solid/kg BOD ₅ removed	Standard A/B
Extended Aeration or Oxidation Ditch	0.4 to 0.6 kg bio-solid/kg BOD ₅ removed	Standard A/B
RBC/SBC/High Rate Trickling Filter System	0.8* kg bio-solid/kg BOD ₅ removed	Standard A/B
Hybrid System	0.4 kg bio-solid/kg BOD ₅ removed	Standard A/B

Refer to Guidelines Vol.4 (under revision)

Table 5.10 Bio-solid Production

PE	Produced Bio-solid (m³/day)	Dewatered Bio-solid (m³/day)
150	0.1	0.01
200	0.1	0.01
250	0.1	0.01
300	0.1	0.01
350	0.1	0.01
400	0.2	0.01
450	0.2	0.02
500	0.2	0.02
550	0.2	0.02
600	0.2	0.02
650	0.3	0.02
700	0.3	0.02
750	0.3	0.03
800	0.3	0.03
850	0.3	0.03
900	0.4	0.03
950	0.4	0.03
1,000	0.4	0.03
1,100	0.4	0.04
1,200	0.5	0.04
1,300	0.5	0.04
1,400	0.6	0.05
1,500	0.6	0.05
1,600	0.6	0.05
1,700	0.7	0.06
1,800	0.7	0.06
1,900	0.8	0.06
2,000	0.8	0.07

Note: sewage treatment using Imhoff Tank

Table 5.11 Bio-solid Production

PE	Produced Bio-solid (m ³ /day)	Dewatered Bio-solid (m ³ /day)
2,000	6.2	0.47
2,500	7.8	0.58
3,000	9.3	0.70
3,500	10.9	0.82
4,000	12.4	0.93
4,500	14.0	1.05
5,000	15.5	1.16
5,500	17.1	1.28
6,000	18.6	1.40
6,500	20.2	1.51
7,000	21.7	1.63
7,500	23.3	1.75
8,000	24.8	1.86
9,000	27.9	2.10
9,500	29.5	2.21
10,000	31.1	2.33
11,000	34.2	2.56
12,000	37.3	2.79
13,000	40.4	3.03
14,000	43.5	3.26
15,000	46.6	3.49
16,000	49.7	3.73
17,000	52.8	3.96
18,000	55.9	4.19
19,000	59.0	4.42
20,000	62.1	4.66
21,000	65.2	4.89
22,000	68.3	5.12
23,000	71.4	5.36
24,000	74.5	5.59
25,000	77.6	5.82
26,000	80.7	6.05
27,000	83.8	6.29
28,000	86.9	6.52
29,000	90.0	6.75
30,000	93.2	6.99

PE	Produced Bio-solid (m ³ /day)	Dewatered Bio-solid (m ³ /day)
31,000	96.3	7.22
32,000	99.4	7.45
33,000	102.5	7.68
34,000	105.6	7.92
35,000	108.7	8.15
36,000	111.8	8.38
37,000	114.9	8.62
38,000	118.0	8.85
39,000	121.1	9.08
40,000	124.2	9.32
41,000	127.3	9.55
42,000	130.4	9.78
43,000	133.5	10.01
44,000	136.6	10.25
45,000	139.7	10.48
46,000	142.8	10.71
47,000	145.9	10.95
48,000	149.0	11.18
49,000	152.1	11.41
50,000	155.3	11.64

Note: sewage treatment using conventional activated bio-solid system

Note: Inflow BOD:250 mg/L, Effluent BOD:20mg/L, Solid content:1.5% for Produced Bio-solid

Solid Content: 20% for dewatered Bio-solid

Future Bio-solid Quantities

When predicting future bio-solid quantities released by STPs, due consideration should be given to potential changes in the form of bio-solid production. For example, it is quite probable that Septic Tank and Imhoff Tank Bio-solid types shall remain constant or reduce in quantity due to their eradication and/or replacement with other types of treatment plant; especially in the case of Imhoff Tanks. Similarly bio-solids produced by small package plants are likely to reduce due to their progressive elimination. With the potential elimination of these inefficient STPs within a Catchment, bio-solids produced by relatively large high rate biological STPs will increase, as the sewage flows shall be diverted to these centralised more efficient STPs.

Categorisation of Bio-solid Quantities

Bio-solid quantities need be categorised under different groups depending on the different management practices that require to be adopted. The manner by which bio-solid quantities should be categorised is presented in *Table 5.12*.

Table 5.12 Temporal Bio-solid Generation Rates Among Various Sectors Of The Project Area (1/2)

Sewage Treatment System	1995						2000					
	1	2	3	4	5	Total	1	2	3	4	5	Total
Septic tank	4,550	1,170	11,420	-	-	17,140	2,600	780	11,420	-	-	14,800
Imhoff tank	6,000	1,780	11,120	-	-	18,900	5,280	1,270	11,120	-	-	17,670
Rotating Biological Contactor	-	-	18,300	-	-	18,300	-	-	40,350	-	-	40,350
Extended Aeration	800	-	10,900	42,480	24,480	78,660	800	-	35,110	62,000	51,525	149,435
Bio Soil	-	7,650(a)	33,010	-	1,275	41,935	-	10,200(a)	55,600	-	1,530	66,790
Sats/Hi-Kleen	2,000	-	6,635	-	-	8,635	2,000	-	19,865	-	-	21,865
Biofilter	-	-	-	-	26,520	26,520	-	-	-	-	37,230	37,230
Anaerobic Digestor (Pantai)	30,500	-	-	-	-	30,500	360,060	-	-	-	-	360,060
Oxidation Pond/ Aerated Lagoon	121,380	13,600	10,600	-	3,555	149,135	121,380	20,620	10,600	-	4,390	156,990

Sewage Treatment System	2005						2010					
	1	2	3	4	5	Total	1	2	3	4	5	Total
Septic tank	1,950	390	11,420	-	-	13,760	1,300	130	11,420	-	-	12,850
Imhoff tank	4,740	790	11,120	-	-	16,650	4,740	320	11,120	-	-	16,180
Rotating Biological Contactor	-	-	55,920	-	-	55,920	-	-	63,420	-	-	63,420
Extended Aeration	800	-	52,205	62,000	73,040	188,045	800	-	60,440	62,000	82,360	205,600
Bio Soil	-	10,200	70,630	-	8,220	89,050	-	10,200	78,130	-	10,080	98,410
Sats/Hi-Kleen	2,000	-	29,205	-	-	31,205	2,000	-	33,705	-	-	35,705
Biofilter	-	-	-	-	42,360	42,360	-	-	-	-	42,360	42,360
Anaerobic Digestor (Pantai)	634,310	-	-	-	-	634,310	783,770	-	-	-	-	783,770
Oxidation Pond/ Aeration Lagoon	610	24,580	10,600	-	6,390	42,180	610	27,790	10,600	-	6,390	45,390

Table 5.12 Temporal Bio-solid Generation Rates Among Various Sectors Of The Project Area (2/2)

Sewage Treatment System	2015					
	1	2	3	4	5	Total
Septic tank	650	65	11,420	-	-	12,135
Imhoff tank	4,740	160	11,120	-	-	16,020
Rotating Biological Contactor	-	-	68,955	-	-	68,955
Extended Aeration	800	-	66,515	62,000	106,940	236,255
Bio Soil	-	10,200	83,665	-	10,080	103,945
Sats/Hi-Kleen	2,000	-	37,025	-	-	39,025
Biofilter	-	-	-	-	42,360	42,360
Anaerobic Digestor (Pantai)	859,790	-	-	-	-	859,790
Oxidation Pond/ Aeration Lagoon	610	28,700	10,600	-	6,390	46,300

- Notes:**
1. Pantai Sewerage Zone
 2. Lower Kerayong Sewerage Zone
 3. Majlis Perbandaran Petaling Jaya
 4. Bandar Sime UEP
 5. North Western Sector/Sri Hartamas/Mount Kiara
- Units are in cu.m\year
 - Bio-solid Production Factors employed are summarised in Table 5.6
 - Source: Consultant’s Derived Estimates

SECTION 6

Issues and Constraints

6.1 Introduction

Consensus on Scope of Sewerage Deficiencies

Having defined the type, capacity and status of existing sewerage systems (facilities) within a Catchment, and having estimated the current and future rates of sewage flow, pollutant loads and bio-solid generation that have to be catered for throughout a defined Planning Period, a consensus can be reached on the scope of sewerage system deficiencies currently prevailing, and on the extent of upgrading and extension works that are required to be effected in the short, medium and long term periods encompassed by a defined Planning Horizon.

Precursor to Identifying Alternative Sewerage Services

Prior to identifying alternative strategies which are able to ameliorate existing deficiencies and to cater for future needs, a concerted effort must be made to identify particular issues and constraints that may either influence the upgrading and extension exercise, and/or limit its effectiveness.

This chapter discusses the basic issues and constraints that need to be addressed prior to identifying alternative bio-solid and sewage collection, conveyance, treatment and disposal concepts either for a Catchment as a whole, or for specific developments that are to be implemented within a particular Catchment.

6.2 Rating of Existing Sewerage Systems

Pollution Load Conditions

The pollution load from the sewerage system depends mainly on the type of sewage treatment plants provided. It is important to know the volume of pollution loads on sewerage system. By summarizing the status of pollution loads on sewerage system, the volume and area/source of pollution loads are identified. This information is very useful to develop the sewerage strategy for areas highly in need of sewerage and for the determination of the phasing plan. Also, by determining the difference between the downstream and upstream water quality, the total pollution loads produced in the river basin is estimated. The status of domestic sewerage can be confirmed by the comparison of the domestic sewage pollution load and total pollution load. In this step each pollution load in Catchment Area is summarized in table and the estimation of total pollution in the river basin are conducted to confirm present domestic sewerage pollution status.

Determine Capability to Handle Predicted Flows and Loading Conditions

The sewage flow and pollutant load predictions that have been previously carried out are employed to, first of all, assess the capability of existing sewerage systems to handle current and projected future hydraulic and mass pollutant loadings; and to determine at which time frame they shall become unable to cope with the

imposed loading. This procedure is particularly applicable to a situation where a proposed development intends to discharge its sewage flows to an existing centralised sewerage system serving the catchment in which the developments is to be situated.

Sewer Line Investigations

With respect to sewer lines, the assessment is carried out by comparing the predicted hydraulic loads at particular junctions (e.g. manholes) along the sewer network system with the inherent conveying capacity of the installed sewer pipeline. Sewer segments which could be overloaded are specifically highlighted on a sewer network plan as shown in *Figure 6.1*.

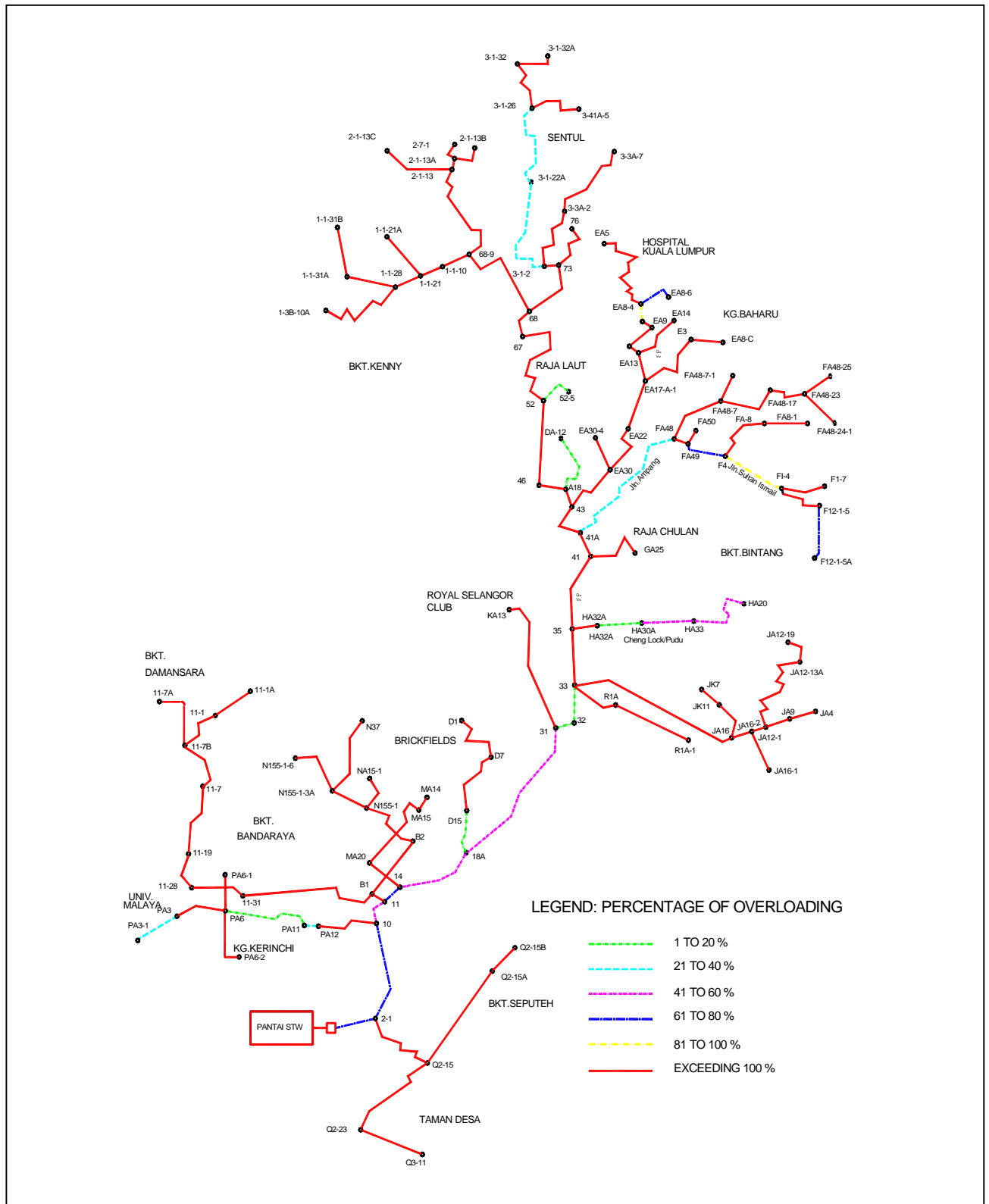

Figure 6.1 Status of Pantai Sewerage Zone Network System (Flow Conditions for Year 2000)

The “over-loading” rate, expressed as a percentage of the hydraulic capacity of the sewer line (determined by its diameter and slope), is also documented at specific time intervals over the Planning Period. Hence those sewer segments with relatively low residual capacity are likely to require augmentation as the flows increase during the tenure of the Planning Period. The analysis should also consider the condition of the sewer system. If there is a high rate of inflow and infiltration (extraneous flows) to the sewers this will need to be identified separately and the impacts of wet weather flows assessed.

Sewage Treatment Plant Capabilities

A similar analysis is carried out for existing sewage treatment plants, and for areas set aside for sewage treatment, to assess their capability to handle existing and future hydraulic and pollutant loads. Such assessments are dictated by specific assumptions made; such as the effluent standards that have to be conformed with, and the range of applicable unit process design criteria to test the system.

The assessment of a treatment plant should rightly be carried out on a unit process level, as summarised in *Table 6.1*.

Table 6.1 Comparative Assessment of a STP

Unit	Design Basis	Loading	
		1996	2010
Imhoff Tank (m ³ /m ² /day at ADWF)	10	36.0	42.0
Primary Sedimentation (m ³ /m ² /day at ADWF)			
Old Works	10	13.0	15.0
New Works	12.5	11.6	13.6
Trickling Filters (g BOD/m ³ /day at ADWF)			
Old Works	200	126 ^a	148
New Works	200	183	214
Humus Tanks (m ³ /m ² /day at ADWF)			
Old Works	20	26.8	31.2
New Works	25	19.7	23.0
Chlorination Tank (min. detention at ADWF)	30	32	27
Bio-solid Digesters (days detention)			
Primary	15	13.8 ^b	17.7 ^c
Secondary	15	16.7 ^b	21.4 ^c
Bio-solid Dry Beds (PE/m ³)			
Old Works	10	7.4	8.6
New Works	10		

Notes:

- a. Assumes 30 per cent BOD₅ removal in primary treatment
- b. Manual bio-solid withdrawal
- c. Programmed bio-solid withdrawal

The assessment must also address whether the mode of conditioning and disposal of bio-solid produced at existing sewage treatment plants, and at off-site dedicated bio-solid processing plants, are satisfactory.

Based on this method of evaluation, the capability of existing plants to cater for current and future sewage flows should be ascertained. In addition the capability of available treatment plant reserve areas to handle existing sewage flows can also be ascertained and compared with flows likely to be channelled to it in the future. This exercise shall indicate whether the land area is sufficient to cater for its Service Area as a whole, or only a part of its Service Area, or whether the land area can in addition handle flows originating from the entire Catchment under Study or from an adjacent Catchment.

Capital Works Implications

Based on information garnered from the assessment exercise described above, the Scope of Works required to augment and expand on current sewerage systems, including bio-solid processing and disposal plants, can be ascertained.

There is a need to classify these Works into a number of discrete categories as defined by the Director General of Sewerage Services. These are as follows:

Growth	Providing new sewerage infrastructure to greenfield developments, or areas undergoing redevelopment.
Concession	serving high priority projects as specified by the Government, as a requirement of the Concession (i.e. Privatisation Agreement)
Backlog	providing new centralised sewerage infra-structure to septic tank areas
Compliance	upgrading of old sewage treatment plants to improve system efficiency
Rationalisation	reducing the number of old sewage treatment plants to improve system efficiency
Refurbishment	refurbishing old sewerage infrastructure to bring it to its design intent
Replacement	replacing old sewerage infrastructure which has exceeded its useful life
Bio-solid	providing new bio-solid treatment and disposal infrastructure
Minor Works	capitalised maintenance and/or works which are small in size

This form of categorisation assists in determining implementation priorities, and those projects which revenues can be generated to finance its implementation.

It should also be noted that the above classification encompasses Works for improving the long term performance of sewerage system (categorised as “Rationalisation, Refurbishment and Backlog”); others are to meet “Compliance, Bio-solid and Replacement”, while “Growth” Category is for new development or redevelopment.

6.3 Issues and Constraints Relevant to Identifying Appropriate Sewerage Service Strategies

The principal issues that should be considered, reviewed and understood when assessing alternative sewerage management strategies for a specific Catchment include : (a) Barriers to Sewage Conveyance, (b) Site Availability to locate sewers, pump stations and STPs, (c) Bio-solid Management and (d) Environmental Factors.

Barriers to Sewage Conveyance

- ◆ *Existing physical infrastructure:* Highways, railway tracks, corridors already congested with a large number of buried utilities, are potential barriers to convenient conveyance of sewage by gravity. The introduction of intermediate pump stations and/or Inverted Systems may be necessary.
- ◆ *Existing natural systems:* The general topography and substrata soil properties may tend to limit the extension of gravity flow sewerage systems. Some pumping is required in all large systems, hence, a preliminary assessment of the “natural” size and layout of subcatchments and their inherent subsoil characteristics, which permit gravity flow of sewage at reasonable depths below ground surface, has to be made. This will influence the viability of rationalising the subcatchments into larger catchments. The presence of natural barriers such as large rivers will tend to separate catchments (unless inverted siphons are tolerable).
- ◆ *Existing sewerage infrastructure:* The size, extent and condition of the sewage collection and conveyance systems and sewage treatment works will have an influence on ascertaining the value of retaining existing structures. If a sewerage system includes sewers that are too small, e.g. that which only serves a portion of sewage flows emanating from a building, or which have deteriorated, then the residual value is low and abandoning the existing system for a good quality system shall be more feasible.

Site availability

- ◆ *Availability of sites:* Within a developed catchment there are only limited sites available for construction of treatment plants, and only limited routes for major sewers. The greatest constraint usually is the availability of sites for treatment plants that are:
 - of sufficient size
 - have adequate buffer zones
 - are correctly located

- have acceptable construction conditions (i.e. reasonable soil conditions, and relatively flat land)
- are compatible with anticipated sewerage schemes
- are available for use or acquisition
- has local and planning acceptance
- near to a fairly large water course that is able to assimilate effluent discharges from STPs.

A critical part of any catchment plan is to identify available sewage treatment plant and bio-solid treatment facility sites, and to ensure the availability of these sites.

Discharge of Treated Effluent

- ◆ *Effluent disposal:* The treated effluent needs to be released back into the environment. This usually means discharge to surface waters, to estuarine regimes, or to foreshore and offshore marine waters. If a suitable receiving water is not available in close vicinity of an STP, the effluent will need to be pumped to an acceptable discharge point that may be far off necessitating prohibitive costs to be expended.

Particular attention has to be focused on determining whether the discharge point is located above a public water supply abstraction point, and if so how far upstream it is to be located. Advanced, stringent, sewage treatment shall be required if the discharge point is located ‘near’ to a public water supply raw water abstraction point. In such cases it may be more feasible and economic to discharge the treated effluent to another water course which is not employed for public water supplies, or to channel the treated effluent downstream of a public raw water abstraction point.

Bio-solid Management

- ◆ *Bio-solid disposal:* All sewage treatment plants generate waste bio-solids that have to be safely managed in an environmentally acceptable manner. The cost of managing sewage bio-solids is significant, usually representing more than 25% of the total cost of sewage treatment costs. All treatment plants need to provide facilities to stabilise and dewater bio-solid. If this is not possible at an STP, the bio-solid will have to be transported to a centralised bio-solid management facility for separate treatment and disposal.

The principal issue to be addressed would be to ascertain whether existing STPs within the Catchment of study can treat bio-solids recovered from septic and Imhoff tanks and from small package STPs; or whether a greenfield centralised bio-solid processing centre has to be identified and implemented.

- ◆ *Local issues:* In many catchments there are specific local issues that influence the overall planning of sewerage services. For example sites of cultural, historical or religious significance, dominant position of a particular industry, areas of administrative responsibility, etc. are factors which may dictate or influence sewerage strategies.

Environmental Factors

- ◆ A particularly important impact which sewerage systems can impose on the environment, is the water quality changes that can materialise from sewage discharges (treated, partially treated or in its raw form). Hence, the degree of sewage treatment needed for a particular discharge condition needs to be assessed. The overall cost of a sewerage plan can be influenced by the degree of treatment required. Other environmental factors such as nuisance, traffic, impact on flora and fauna are usually considered as “non cost” factors. However, in certain specific cases a particular non water quality issue becomes important and influences the plan. For example if a potential site is located within a high value amenity area (e.g. pristine recreational area, bathing beaches, high class residential areas) it may not be available for a treatment plant.

Sewerage provisions for catchments located upstream of raw water intake points for public water supplies needs to be particularly addressed, in terms of preventing contamination of raw water systems and inducing corresponding adverse public health impacts. In this context the location of an STP and its effluent discharge point, in relation to the raw water abstraction point, must be particularly studied (as discussed earlier).

- ◆ *Nature of development:* There are basically three types of development:
 - *infill*, i.e. adding new buildings on vacant blocks within a developed area
 - *redevelopment*, i.e. replacing a building with a new building
 - *perimeter or greenfield*, i.e. developing a new area.

The impacts of the different types of development will result in different flows and load patterns. Infill will increase loads on existing systems, redevelopment also increases existing loads, and if the redevelopment is of a different type to that replaced it will change the characteristics of sewage discharge. Greenfield developments can be expected to be similar to that planned, but are more difficult to predict actual flows and loads because it requires a new system and not the addition of an increment to an existing system.

Overall Effects

Based on the above deliberations it is clear that the following important factors shall require investigating into as a pre-requisite for identifying potential alternative strategies, viz:

- ◆ availability of greenfield sites for new treatment plants; availability of land around existing plants that can be procured to extend the capacity of the system.
- ◆ capacity of sites to provide sewage treatment and bio-solid management
- ◆ routes for major sewers to transfer sewage (a) within existing catchments, (b) for new catchments and (c) between catchments.
- ◆ disposal points for effluents and required effluent standards
- ◆ quality and quantity of bio-solids to be generated and their respective disposal routes.

6.4 Issues Pertinent to Developers

Developers carrying out Sewerage Catchment Planning studies for individual or collaborative projects should factor into their selection of alternative sewerage management strategies the following considerations, viz:

Enhance Overall Effectiveness of Sewerage Management

- ◆ Whether their proposed development can provide the means to enhance the overall effectiveness of sewage and bio-solid treatment within the Catchment in which they are located by providing sufficient land area to accommodate sizable sewage and bio-solid treatment plants. In this manner the Developer could assist in rationalising the number of sewage treatment plants located within the Catchment through eradication of small inefficient non-conforming systems. An analysis of options is warranted to determine the optimum land area to be set aside within the Development to adequately serve the sewerage needs of the Catchment in which it is located.

Reliance on Existing STPs

- ◆ Whether the Developer can rely on external STPs to handle sewage flows to be generated by the proposed development without compromising on the effectiveness of sewage treatment for the entire catchment. In this manner the Developer can maximise the productive use of land within their proposed development. A Sewerage Catchment Planning study encompassing the entire Catchment has to be carried out by the Developer to prove the viability of this alternative strategy. The above deliberations shall constitute the main impetus for Developers to plan out an optimum sewerage service for the locality in which they are situated.

SECTION 7

Identification And Assessment Of Optional Sewerage Management Strategies

7.1 Introduction

The data gathering phase of the sewerage catchment planning process provides the required background material or information to identify potential optional sewerage management strategies that can be considered for a particular Catchment; including the optional roles which a new development can play in enhancing or complementing a permanent sewerage management concept. Knowledge of the following important factors provides the basis for identifying and evaluating sewerage management options, viz:

- ◆ the existing sewerage system,
- ◆ anticipated changes in sewage flows to be catered for,
- ◆ issues and constraints pertaining to sewerage management, and
- ◆ viable STP sites, sewer routes and catchment physiography

A detailed techno-economic evaluation can only be applied to a limited number of options, hence skill and judgment is needed to screen through a host of potential options with the aim of eliminating non viable options usually because they fail to meet a critical constraint for the catchment. As such a short list of viable options is prepared for detailed scrutiny.

This Chapter discusses the issues and criteria which can be employed to carry out a thorough assessment and evaluation of the *technical* merits of sewerage management options. The next chapter, i.e. *Chapter 8*, discusses the financial criteria and procedures for conducting an economic comparison of the short listed options.

7.2 Initial Screening of Options

Many Options are Theoretically Possible

The actual number of different sewerage strategy options available for any catchment is very large. For example, if there are four possible sites for sewage treatment plants within a catchment (i.e. Sites A, B, C and D), and the sewage can be transported to any or all of these sites for treatment, there are several possibilities as to which of the sites will be used, viz:

- ◆ Four options using a single site, A, B C and D.
- ◆ Six options using two sites, A and B; B and C; C and D; D and A; A and C; B and D. However for each of these options there are four alternatives for example with A and B - the C and D area drains to A; and C and D area drains to B; D area drains to A; and C area drains to B; D area drains to B; and C area drains to A. Hence, a total of 24 options.

- ◆ Four options using three sites, A, B and C; B, C and D; C, D and A; D, A and B; again for each of these options there are three alternatives for example with sites A, B and C the flows from area D could go to any of the three sites. Hence a total of 12 options.
- ◆ There is only one option using all four sites.

Hence, even for this simple example just considering the number of sites and the relevant loads there would be 41 option to analyse. In practice, it is necessary to reduce the number of options for analysis in order to make the analysis feasible and understandable. The alternative is to set up a computer based analytical system which could manage the financial analysis of a range of options as described above; but this option will not be able to analyse non cost related functions.

Eliminate Unsuitable Options

The most effective method to simplify the analysis is to eliminate some options based on a qualitative or semiquantitative analysis. For example, if Site A were theoretically possible as a sewage treatment plant site, but had severe limitations such as limited available area, poor site conditions, situated in an environmentally sensitive area, close to sensitive residences or has high operating costs, it may be possible to eliminate Site A prior to more detailed analysis and only consider three potential sites.

In order to eliminate the relatively impractical and cost prohibitive options it is necessary to:

- ◆ Identify issues and constraints that will apply.
- ◆ Identify available options.
- ◆ Assess the impact of the issues and constraints on the options.

7.3 Sewerage Management Alternatives

Several alternatives are available to provide a viable sewerage management scheme. They will be based upon upgrading and augmentation of the existing system, provision of new works or some combination of these. In all cases the plans will have to consider treating the sewage and managing the generated bio-solid to set criteria. Certain options that can be considered are described herewith.

System Upgrade, Replacement and Refurbishment

For areas that are not expected to have significant increases in flow and load, it is feasible simply to *upgrade* the existing system. This will require improvements to the treatment plants to achieve the required effluent standard; for example provision of additional clarifiers to prevent suspended solids carry over.

Similarly, if a treatment plant contains processes or equipment that are inefficient or unsuitable to maintain a required performance, a *replacement* programme could be carried out; for example replacing an Imhoff/biological filter system with an activated bio-solid treatment system or equivalent high rate mechanised treatment system.

Certain portions of an existing sewerage system may be capable of providing the required performance if it is in good condition. However due to poor maintenance, or if the system has deteriorated due to old age, the performance may become unacceptable. In this case a *refurbishment* programme could be carried out to replace or reinstate parts of the sewage transport system (e.g. broken sewers, pump stations) and treatment plant (equipment such as pumps, scrapper, aerators and structures).

New Sewerage Works

The most common cases where *new sewerage works* may be required are for new development areas (greenfield), and for areas which have been served by treatment systems that currently are considered to be inadequate (e.g. septic tanks).

For a new development area the sewerage system is usually provided by the Developer; nevertheless some systems may be implemented by the Sewerage Concessionaire (i.e. IWK). In planning terms the net result is the same, however the costs to the Sewerage Concessionaire and to the Developer will depend upon the details of the system and its operation.

An area that is served by septic tanks will require the provision of a system to provide a higher degree of treatment. In this case the existing septic tanks would be systematically taken out of service and the sewage channelled into a sewer network system that discharges into a new modern sewage treatment plant which is capable of meeting established effluent discharge standards.

Plant Rationalisation and Economics of Scale

In Malaysia there are thousands of sewage treatment plants, the vast majority of which treat sewage flows generated by a PE Count of less than 1,500. In a particular Catchment such small treatment plants may be separated by only a few hundred metres. There are *economies of scale* associated with the construction and operation of treatment plants. Hence a single large plant may be more economical than several small plants totalling to the same capacity. It is also often difficult to obtain high quality effluents and manage bio-solid disposals from small plants. By combining independent sewerage systems served by small treatment plants, and draining the sewage for treatment at a smaller number of larger centralised plants, overall benefits can materialise. The rationalisation of smaller plants or of plants which are no longer viable or require major reinvestment, is expected to be an important factor to consider in evaluating alternative sewerage management options.

Bio-solid Management

The treatment of sewage to produce an improved quality of effluent means that the solids are separated out as a bio-solid. The bio-solids as generated usually contain low amounts of solids (0.5-4%) and high amounts of water (96-99.5%), in addition the bio-solids will tend to be malodorous and contain high concentrations of pathogens. Hence they require stabilising or conditioning before they are suitable for disposal to the environment. Sewage bio-solids are usually processed by:

- ◆ *Thickening* to increase the solids content to 4-10%, and thereby to significantly reduce the bio-solid volume (to approximately one tenth of the original volume).
- ◆ *Stabilisation* to reduce the organic content and/or to kill pathogens, this is achieved by aerobic digestion, anaerobic digestion or lime treatment.
- ◆ *Dewatering* to produce a “dry” bio-solid which can be easily handled and transported (more than 20% solids content).

Bio-solids generated from basic sewage treatment processes will need to be processed by one or several of these methods prior to disposal. If a bio-solid management facility is not provided at a STP site, the bio-solid will need to be transported (usually by road) to dedicate centralised processing plants.

The basic bio-solid management concepts are shown in Figure 7.1. The onsite strategy and centralised strategy should be considered and compared on technical, economical and environmental grounds.

For an onsite strategy, each STP has its own bio-solid treatment facility. Capital cost, O&M, and disposal costs for each bio-solid facility are considered.

For a centralised strategy, one or some of STPs will have bio-solid treatment plants to which bio-solid produced from the other STPs is transferred. Capital cost for the centralised plants, bio-solid transportation/conveyance cost, O&M and disposal costs are considered.

With respect to the treatment process, all bio-solid should be thickened and dewatered before the disposal to reduce the volume of bio-solid.

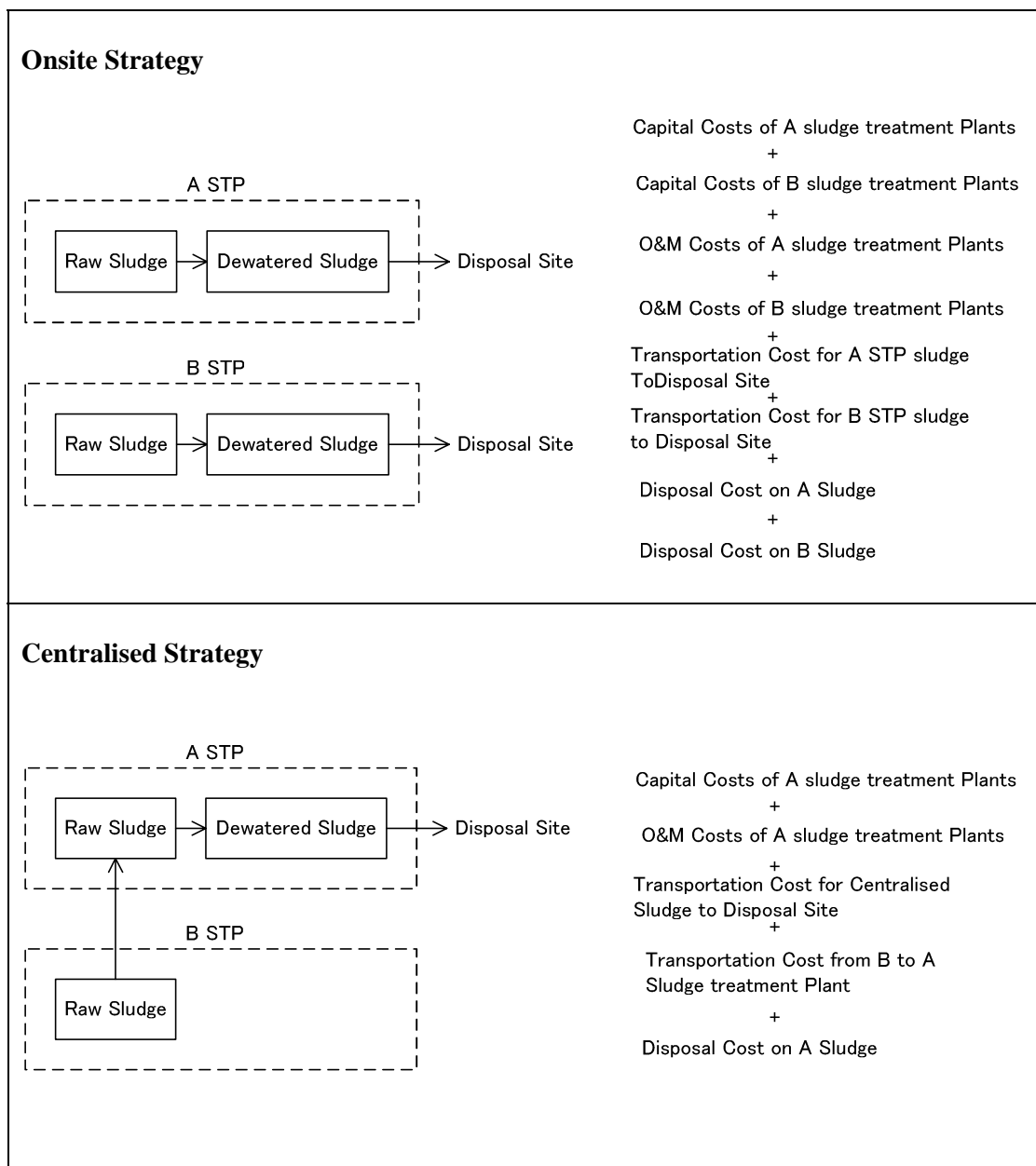

Figure 7.1 Example of Bio-solid Management Alternatives

Combinations

Any of the above options can be combined with one and another to form a viable sewerage management strategy. The potential combinations are presented schematically in *Figures 7.2 to 7.7*. The concept of providing additional capacity at an existing STP to provide sewerage services for a new development is respectively depicted in *Figures 7.2 and 7.4*. On the other hand a new development could provide sewerage services to external areas that do not have proper treatment facilities. The general layout of the existing and proposed new developments would suggest that such schemes would be cost effective due to the:

- ◆ efficiencies in operating a single larger plant
- ◆ low capital costs because of the space capacity in the existing system
- ◆ short sewer connection to an existing or proposed system

However additional capital shall be required to uprate the existing STP if it can be accomplished.

A similar scenario to that depicted in *Figure 7.2* is portrayed in *Figure 7.3*. The latter schematic indicates that new trunk sewers to be laid in a septic tank area may be sized to convey sewage releases from upstream proposed developments and adjacent sub-catchments to a new central STP.

The case where two or three developers collaborate to build a single STP to serve their respective developments is depicted in *Figure 7.5*. In this case land area within one of the developments will need to be alienated for sewage treatment. Alternatively a greenfield site located external to all three developments shall be jointly purchased. This scenario would be feasible if the developments were to occur simultaneously or soon after one another.

A similar rationale would also apply to a large development that will be implemented in stages over a specific time period (Refer to *Figure 7.6*). In this case modular treatment plants can be implemented in phase with the Project's staged development. A suitable land area should be set aside from the beginning to cater for all phased modular STP units.

Rationalisation of Small STPs

A particular Option that needs to be addressed is the potential to rationalise existing and proposed treatment plants (STPs). The principal aim is to reduce the total number of individual STPs serving a Catchment, and to eliminate those that are of limited capacity to serve future PEs, and those that are inefficient (e.g. Septic Tanks, Imhoff Tanks). There are several approaches that can be considered they being:

- ◆ Identify a greenfield site to accommodate a large enough STP that can take the place of several small STPs existing and those contemplated in the future. A proposed development may have the capability to assist in this manner by providing land space. Otherwise the Sewerage Concessionaire would need to purchase suitable land area within the Catchment as identified by a Sewerage Catchment study.
- ◆ Convert existing STPs into uprated systems to treat a larger sewage flow, thus enabling sewage flows that are treated by small STPs to be routed to this plant instead. Existing and planned Oxidation Ponds/Aerated Lagoons are prime candidates for upgrading into higher capacity STPs since their land areas are relatively large.

The Catchment Study should focus on ascertaining how many central STPs can be provided to replace small systems. One uprated or new STP may not be

economical or practical. It may be more prudent to provide two central STPs to serve different parts of a Catchment. Only a techno-economic appraisal of the alternatives can throw light on the latter option. Availability of land areas to accommodate new plants or to upgrade existing plants, and the scope of new trunk sewers, or extensions to existing sewers, may constitute the deciding factor. In deciding on a preferred option, managing bio-solid should also be given due consideration.

Combination of any or all of the above highlighted alternatives need to be considered and evaluated. The actual catchment plan will include a mixture of any or all of these approaches (Refer to *Figure 7.8*). What is required is to analyse the different approaches with respect to cost implications, practicality and technical adequacy.

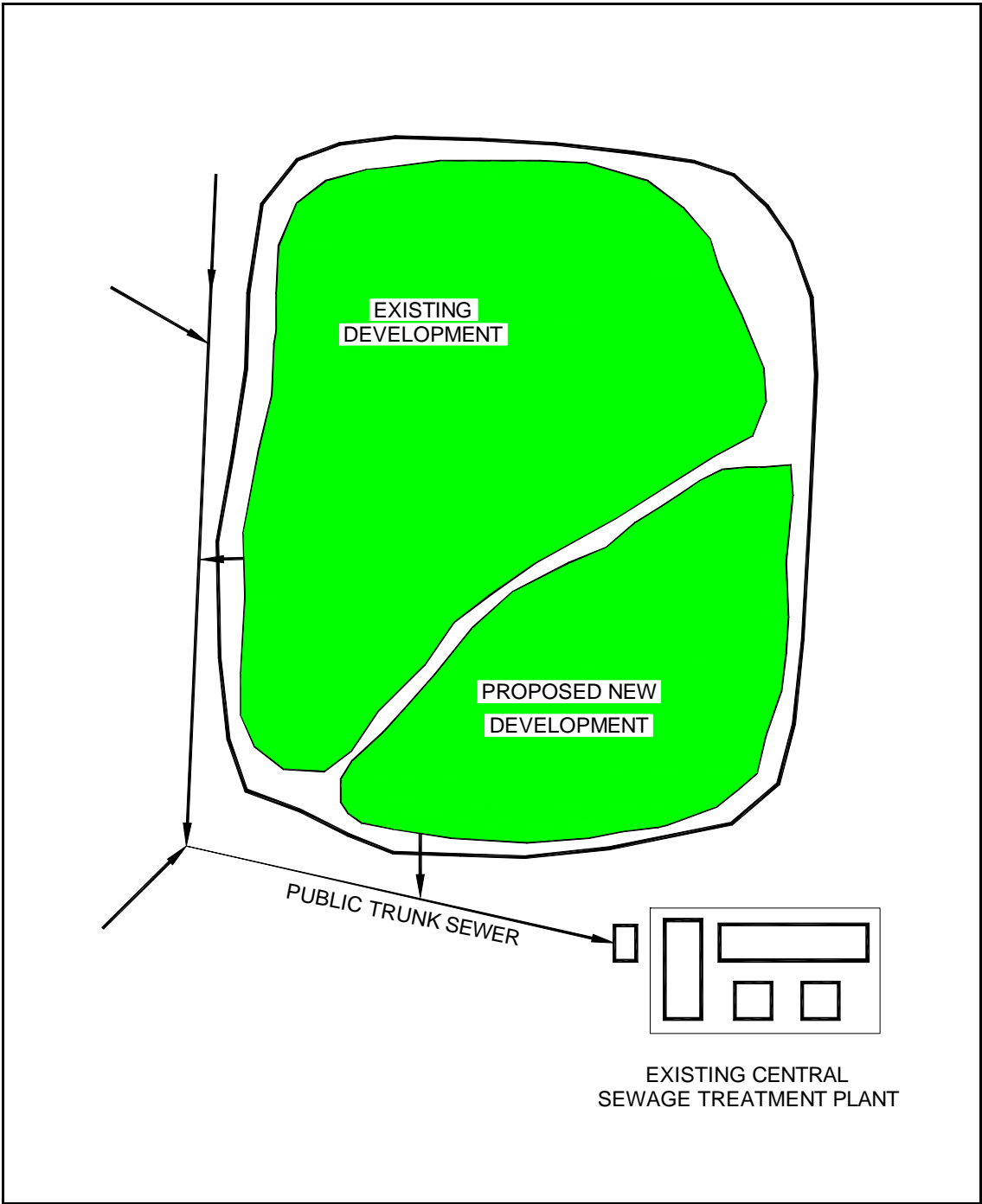

Figure 7.2 Link to Existing Public Sewer and Central Sewage Treatment Plant

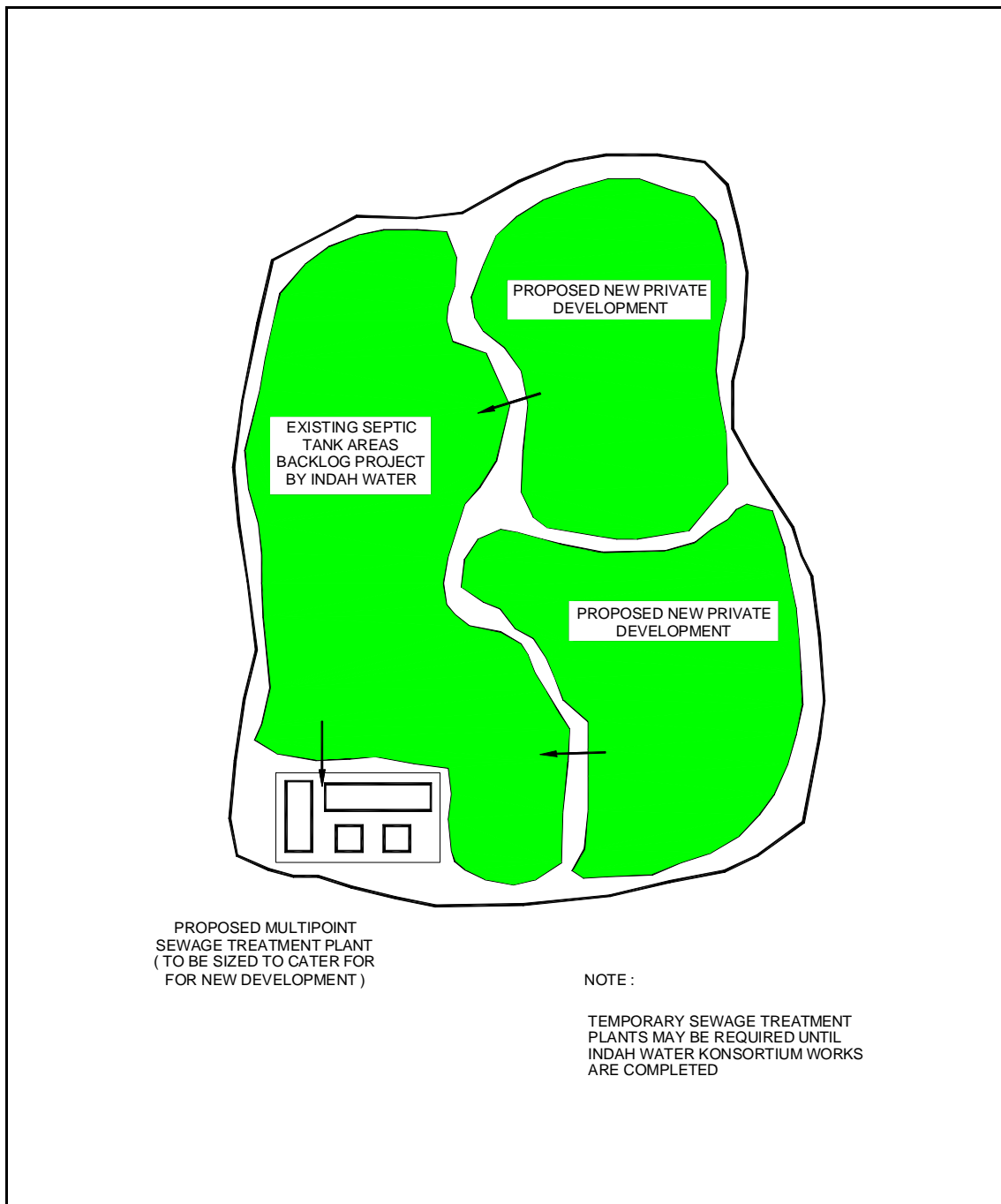

Figure 7.3 Link-up to Proposed Sewage Treatment Plant Proposed to be Constructed by Indah Water Konsortium

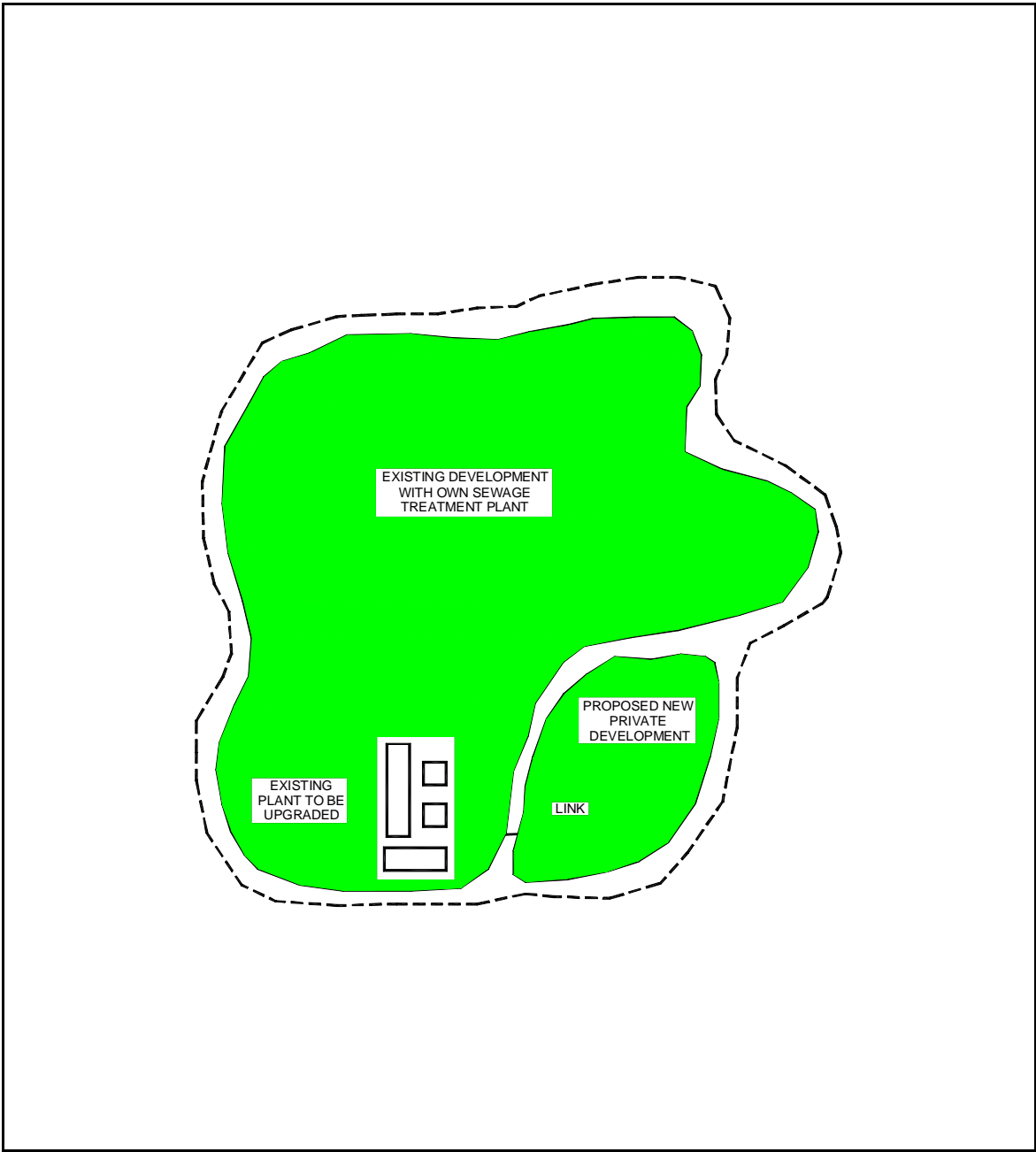

Figure 7.4 Upgrade Existing Connecting Sewer Network and Sewage Treatment Plant

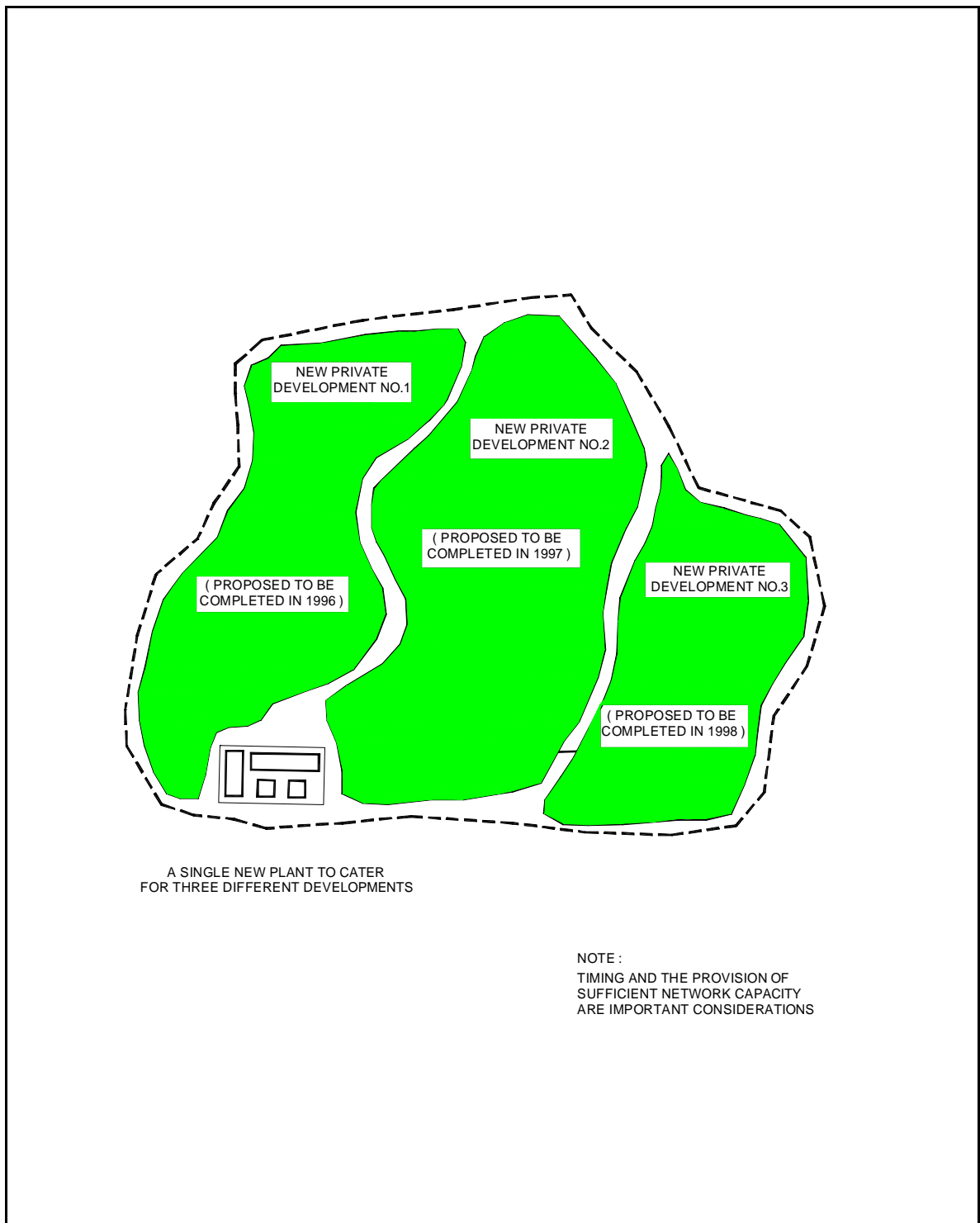

Figure 7.5 Collaborative Effort between Two or More Private Developers to Jointly Build a Single Large Centralised Sewage Treatment Plant

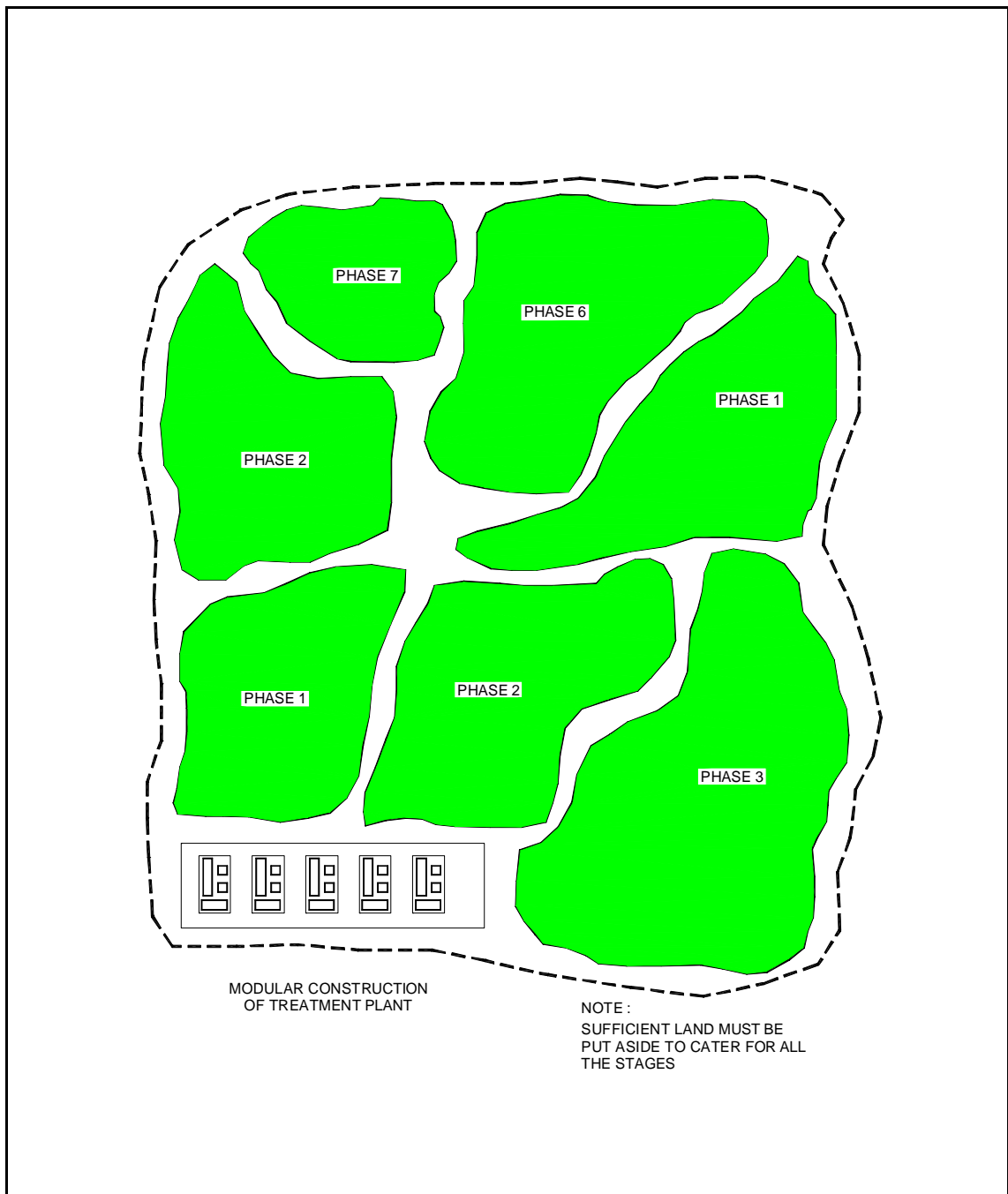

Figure 7.6 Staged Modular Construction of Treatment Plants at a Single Location for Large Greenfield Developments being Developed in Stages

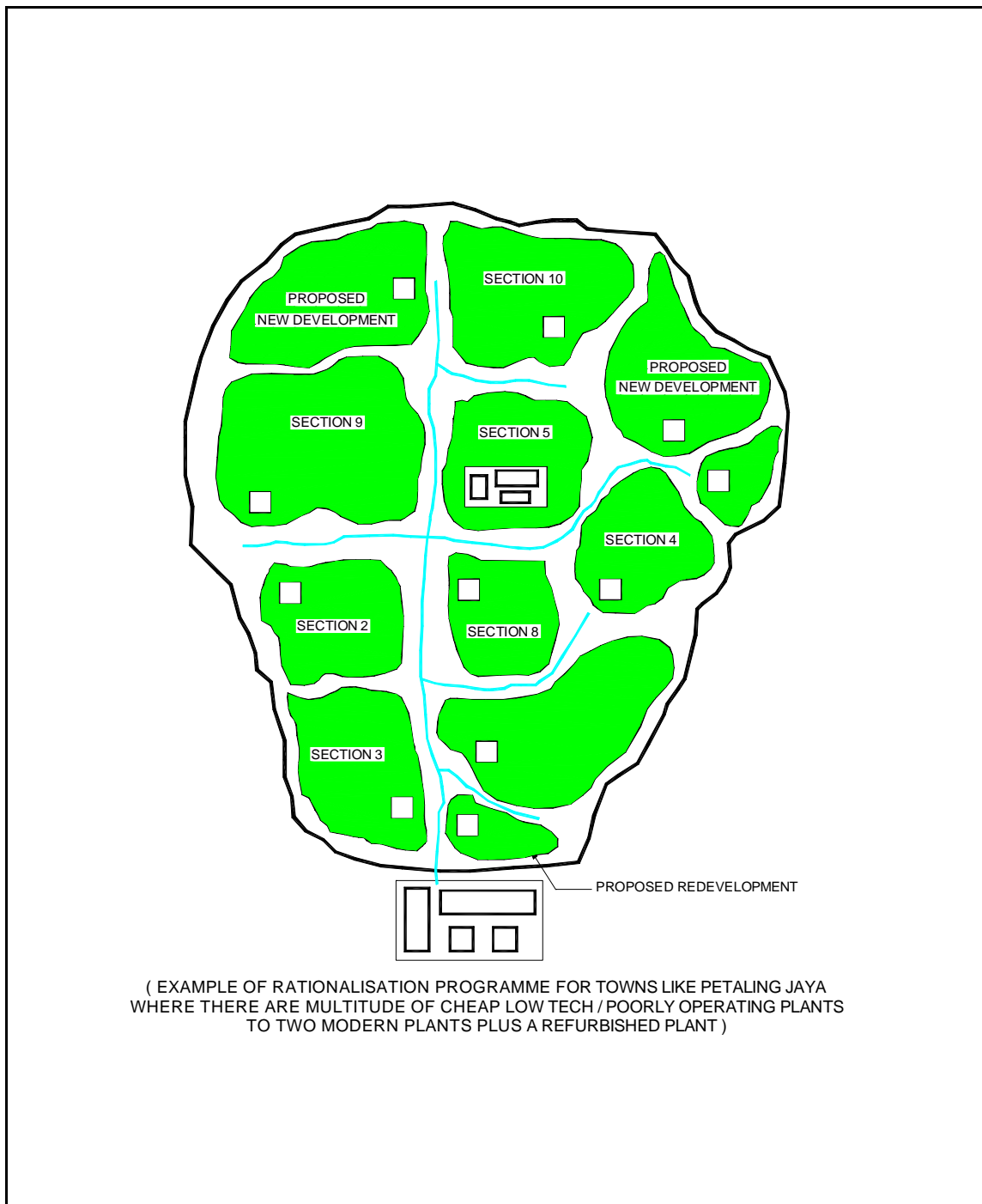

Figure 7.7 Rationalisation of Existing Small Low Tech Plants to New High Tech Plants

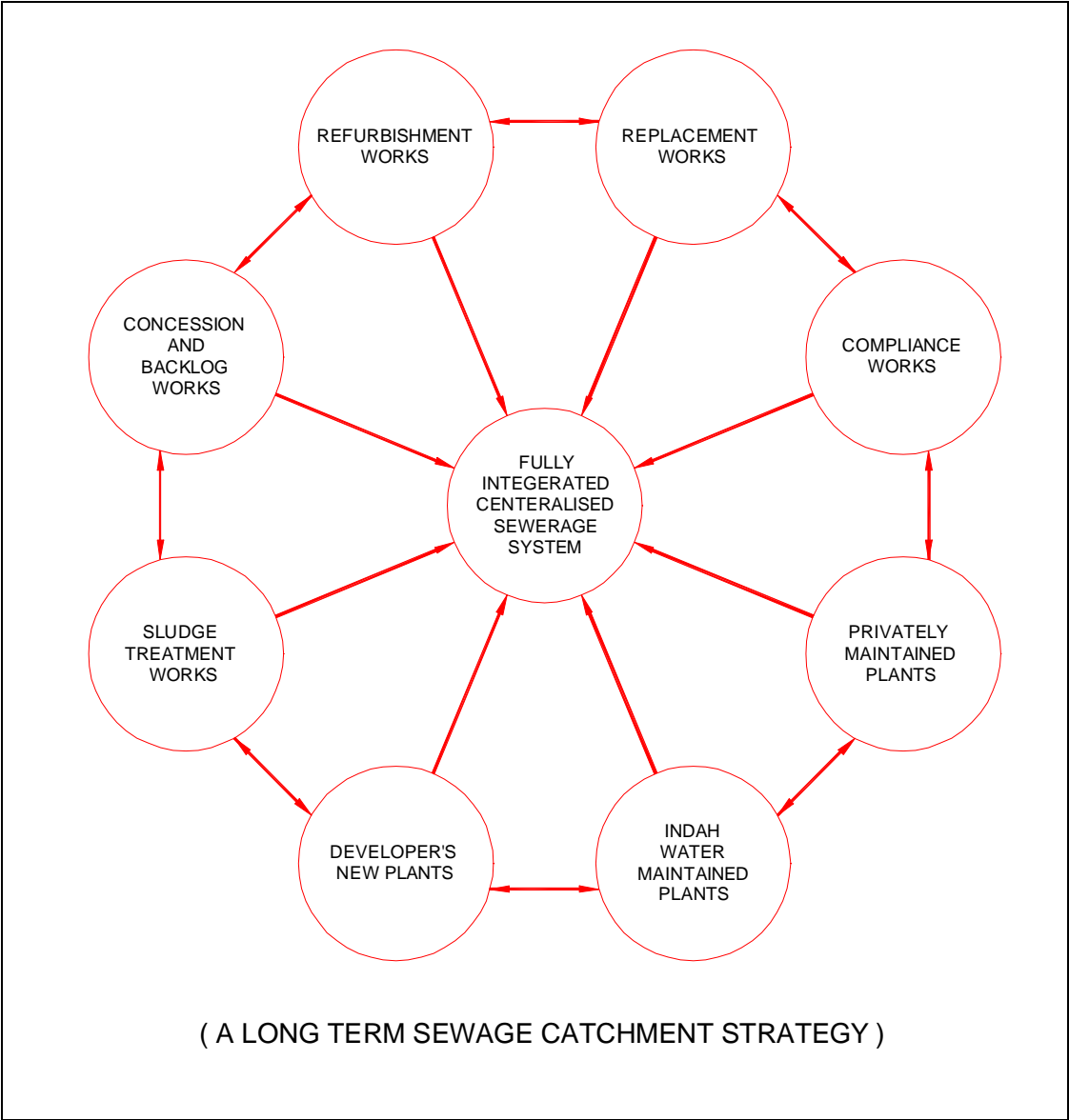

Figure 7.8 Fully Integrated Centralised Sewerage System

7.4 Identification of Options for Analysis

Brainstorm or Multicriteria Analysis

The type of alternative options illustrated in *Figures 7.2 to 7.7* should be established for the catchment. For most catchments this will result in a long list of options, even accounting for the simplifications provided by screening out options by considering Issues and Constraints as discussed earlier. In order to simplify the number of options two basic methods are available, brainstorming and multicriteria analysis. In brainstorming a group of informed persons consider each option and argue out the advantages and disadvantages of each option, until a consensus is reached on which options should be retained and which discarded. The arguments are subsequently documented to justify the selection.

Multicriteria analysis requires the “scoring” of options against the critical issues for that catchment. Issues or constraints that are overriding (for example available land area or effluent quality) should have been used to eliminate some options prior to the analysis. The actual criteria are set either by the client, informed personnel or the Planner. Typical criteria could incorporate:

- ◆ Costs - capital, operation, maintenance, NPV
- ◆ Environmental impacts induced by the systems
- ◆ Health and safety
- ◆ Impact on public
- ◆ Operability
- ◆ Flexibility
- ◆ Complexity

Select and Weight Criteria

The criteria then needs to be weighted to reflect relative importance. A typical score card representing a Multi-criteria Analysis is depicted in *Table 7.1* below:

The score of weight is given on the extent of importance of each criterion in evaluation. High weight is given on the criterion that is more important than others. Score of weight should be marked on each criterion on which the summation of scores is 100.

Each criterion is defined as follows.

Total Capital Cost

Total Capital cost consists of all capital costs during sewerage planning span. It is chosen for minimising a capital cost which is an important criterion to be analysed during the selection of options. Usually a high weight is given for these criteria.

Net Present Value

The net present value method is most commonly used for comparing the different Sewerage Management Strategies. This procedure essentially converts future costs and benefits into equivalent present day costs and benefits. Negative NPV indicates that external money must be put on the project other than tariff revenues. Sewerage project which has bigger NPV (close to zero, in case of negative number) shall be given higher priority from the financial viewpoint.

Pollution Load Reduction

Pollution load reduction shows the potential of each option to reduce pollution load to the rivers with reference to evaluate and justify the amount of investment made or to be made. This is calculated by the pollution load reduction divided by total cost including capital and O&M cost during sewerage planning span. High pollution load reduction substantiates a cost effective option.

Rationalisation Benefit as Reduction of STP No.

This criterion shows the extent of rationalisation that could be achieved, which is one of the most desirable effects or output of catchment strategies. Rationalisation of STP has lots of opportunities to solve many problems in sewerage sector such as the lack of man power for O&M and etc. Options with higher rationalisation potential are scored with higher marks.

Inclusion of Bio-solid Treatment

Options which include comprehensive and integrated bio-solid treatment facilities are accorded high marks as it generally advocates a systematic approach to sludge management.

Flexibility on Option

A typical span of sewerage planning is usually 20-30 years. Conditions initially associated with a certain sewerage area could change during the planning span due to its prevailing economical and social needs. Options that provide some degree of flexibilities might be advisable for an area where a sewerage catchment strategy is being prepared for the first time as there will be many implementation phases during the planning span in comparison to review of an existing sewerage catchment strategy. For the first time sewerage catchment strategy and long planning span, flexibility is important and weight could be higher.

Land Acquisition Status for Reliability of Project Implementation

Land status of STP is a key factor that shows the extent of reliability of project implementation. For instance when the proposed STP site is a private land, it could be a time consuming task to acquire the land. There is high possibility to delay the project due to uncertainty of its land availability. If a proposed site had been acquired or it is a state land, then its weight could be higher in comparison to privately owned land.

Table 7.1 Multicriteria Analysis for Evaluation of Options

Criteria	Weight
Total Capital Cost	30
Net Present Value	20
Pollution Load Reduction (Reduced Pollution Load / Total cost expressed as BOD kg / RM /day)	20
Rationalisation Benefit as Reduction of STP No.	10
Inclusion of Bio-solid Treatment	10
Flexibility on Option	5
Land Acquisition Status as Reliability of Project Implementing	5
Total	100

Each of the identified options should be shown as a simple schematic such as those represented in *Figures 7.1 to 7.6*. Then each option is scored by a selected group of personnel. The simplest method usually is to:

- ◆ Score each option out of 10 for each criteria
- ◆ multiply each score by the weighting factor to give the required score
- ◆ identify any score that has significant differences between different reviewers. If so obtain clarifications from the individuals, and revise the scores if appropriate
- ◆ provide a consolidated listing for each option
- ◆ from the totals select the most preferred options for more detailed analysis.

Score, Correlate and Justify Marks

An example of the scoring for two options, X and Y, against the criteria summarised in *Table 7.1* is presented in *Table 7.2*. Notice higher marks mean a better or more acceptable option.

Table 7.2 Comparison of Options X and Y

Criteria	Weight	Option X		Option Y	
		Mark	Score	Mark	Score
Total Capital Cost	30	9	27.0	9	27.0
NPV	20	9	18.0	5	10.0
Pollution Load Reduction (Reduced Pollution Load / Total cost expressed as BOD kg/day/RM)	20	9	18.0	5	10.0
Rationalisation Benefit as Reduction of STP No.	10	7	7.0	5	5.0
Inclusion of Bio-solid Treatment	10	7	7.0	5	5.0
Flexibility on Option	5	9	4.5	9	4.5
Land Acquisition Status as Reliability of Project Implementing	5	9	4.5	9	4.5
Total	100		86.0		66.0

In this case Option X is better than Option Y mainly due to its simpler operations and maintenance. However, neither option meets all of the selection criteria and probably only Option X would be on a short list for further analysis.

Select Preferred Sub Option e.g. Bio-solid Management

As part of the selection procedure it is often possible to segregate the overall analysis into specific sub-processes so that a more comprehensive evaluation is carried out. For example if an option such as that shown in *Figure 7.3* were being considered, there are several alternatives for bio-solid management per se. For example alternatives such as each STP is to have its own bio-solid processing facilities as against a central dedicated bio-solid treatment accommodating bio-solid transported from different STPs. If there were a critical criteria such as size limitations, access, or odour generation, it may be possible to eliminate one of the sites for bio-solid processing. If there is no real difference between the two sites as an area for bio-solid processing, then cost can be used as a method to select the preferred site option. In this case it would be necessary to compare:

- ◆ For each plant the capital and operating costs for bio-solid management,
- ◆ The capital and operating costs of a single bio-solid facility plus the transport costs for moving the bio-solid from each STP to the central bio-solid facility.

Components of a potential scheme may need to be subjected to separate analysis in order to establish a preferred treatment system. For example a financial analysis of different processes required to upgrade a small treatment plant to provide improved treatment and to provide a bio-solid treatment system is summarised in *Table 7.3*. Notice in this example where additional processes are added (bio-solid treatment) the operating and maintenance costs represents a high proportion of the total system Net Present Value (NPV). Bio-solid handling for option 2 is always less than bio-solid handling for options 1 and 3 and this has the greatest influence on the overall total cost. The preferred cost option is plant upgrading (C) with chemicals used to reduce phosphorus concentrations and aerobic digestion of bio-solids. This can then be used as a preferred treatment plant choice throughout the analysis.

Table 7.3 Comparison of Treatment Plant/Bio-solid Facilities Options

Process Option	Effluent Upgrading	Bio-solid Handling Option	Net Present Value (\$000's)		
			Capital Cost	O&M Cost	Total Cost
A. Extended Aeration	Biological	1	1418	5060	6479
		2	1349	3806	5155
		3	1156	8894	10049
	Chemical	1	1405	5237	6642
		2	1344	3899	5244
		3	1171	9278	10449
B. Additional Lagoon	Biological	1	1534	5077	6611
		2	1465	3863	5328
		3	1202	7924	9126
	Chemical	1	1381	5060	6442
		2	1320	3777	5098
		3	1151	8586	9737
C. Plant Upgrading	Biological	1	1502	5062	6564
		2	1606	3940	5546
	Chemical	1	979	4718	5697
		2	1091	3527	4618

7.5 Listing of Favourable Options

The above described procedures shall enable impractical, costly and untenable alternatives to be eliminated, and facilitate a listing of more favourable schemes to be subjected to in-depth analysis.

Financial Analysis of Listed Options

A thorough financial analyses of selected favourable schemes needs to be carried out in order to firm up on a preferred sewerage management strategy. This will require a description and layout of the options in sufficient detail to permit costing and analysis. This could include:

- ◆ Layout and specification of the required changes at the treatment plants.
- ◆ Layout of routes for sewer lines to transport sewage to the identified treatment plant sites. This should include details of the actual sewers, particularly if there are specific issues such as construction in built up areas or crossing major obstacles.
- ◆ Refurbishment or new works that are common to all options and therefore can be separated from the analysis.
- ◆ Discharge or disposal points and criteria for effluents and bio-solids.

7.6 Post Script

This Chapter has outlined the basic procedures which can be adopted to identify potential sewerage management concepts for Catchment Areas based on addressing basic issues associated with sewage treatment and bio-solid management. The intention being to address the concept of sewage and bio-solid treatment first and then to analyse the appropriate sewerage conveyance strategies that can be implemented.

The process of screening through the alternatives to short list a few number of viable options (not more than three) for in-depth techno-economic analysis has also been discussed. It is apparent that financial analysis of alternative strategies presents a more quantifiable approach for selection of a preferred option. In this regard a more comprehensive discussion on the costing of facilities, and the financial analysis of options, is presented in the next chapter before proceeding on to relating specific methodologies for undertaking a detailed analysis of options with a view towards ranking them in order of merit.

SECTION 8

Financial Analysis of Options

8.1 Introduction

This Chapter discusses the principal concepts associated with the costing and financial analysis of sewerage schemes. The fundamentals described herein shall provide further guidance in the selection of viable or favourable sewerage development schemes, and for carrying out detailed evaluation of favoured schemes in order to identify a preferred scheme.

8.2 Costing Basis

Need for Costing

Comparison of costs is often one of the few criteria on which options can be quantitatively assessed against each other. Other criteria tend to be at least semi quantitative and usually require considerable qualitative judgment. A sewerage system will entail capital expenditures. In addition recurrent operation and maintenance costs will have to be incurred to maintain or replace equipment, and to make processes work, e.g. effecting periodical removal of solids from sewers, providing electric power for pump stations and sewage treatment plants, supplying chemicals for sewage or sludge processing, etc. The combination of these two components of the cost needs to be accounted for in the analysis.

The validity of any comparison of costs between options requires reliable pricing information, and updated information on market prices for specific work items and plant and equipment. In addition the relative impacts between a one off capital expenditure and ongoing running costs becomes important and requires a valid method of comparison (such as employing discount rates, analysis period, etc.).

Establish Basis for Costing

Prior to carrying out a financial analysis of options, unit costs for various work items and purchase of plant and equipment should be established. This will require:

- ◆ collection of data on similar recent schemes
- ◆ information on current construction unit rates
- ◆ preliminary assessment of costs and complexity of specific works
- ◆ weighting factors to be applied to unit rates to account for specific conditions that have to be met such as laying sewers in difficult areas, conforming to restrictions imposed on laying at night time periods only, and having to install sewers by non-trenching methods; this will require research into local conditions
- ◆ data on costs of specialist equipment and processes
- ◆ information from knowledgeable personnel on operations and maintenance costs
- ◆ information from local and overseas costing manuals

8.3 Life of Assets and Residual Value

Identify and Assess Residual Assets Values

The sewerage industry is characterised as having relatively long life assets and this becomes critical in the business management of the industry. The industry needs to understand the value of its existing assets, how much longer they are expected to last and the funds that are required to replace or refurbish the assets.

Different elements of the sewerage system will deteriorate at different rates e.g. sewers should last a long time while mechanical equipment may require replacement after only 10 years. In addition some of the assets have little or no value at the end of their working life, e.g. mechanical and electrical equipment. Sewers have a greater residual value as they may be rehabilitated in-situ (a less expensive proposition in comparison to excavation and replacement of pipes).

Rate of Depreciation Affects Budgets

The rate at which an asset deteriorates with time is termed as *depreciation*; a factor which is included as a cost item in the accounting process for the owner of the asset. The owner should be budgeting to “save” the annual rate of depreciation of the asset such that there are sufficient funds available to eventually replace the asset. Slower rates of depreciation mean assets last longer and less money has to be “saved” each year to replace them. Obviously revision of the lives of assets can have a significant impact on the financial position of the asset owner, e.g. shortening the lives of assets creates pressure on budgets. Incorrect assessment of asset lives means an annual budget shall over or under estimates real costs.

As part of the overall assessment of existing sewerage schemes, it is necessary to evaluate the current status of existing assets. Actual site evaluation is the most reliable method and can often be undertaken for sewage treatment plants. For sewers it is more difficult. In the absence of site information, assumed asset lives and hence asset values have to be made.

Treatment plants are likely to be made redundant due to performance standards changing over time, causing existing technology to be superseded, rather than the asset reaching the end of its useful life. Hence it is appropriate to ascribe a zero residual value to treatment plants. Some components of the asset will tend to require more frequent replacement e.g. control systems, while large concrete civil structures can be expected to last for longer. Sewage pumping stations also tend to have little residual value at the end of their useful life. The mechanical/electrical equipment tends to be worn out and it is more appropriate to replace civil structures.

Asset Lives Depend Upon Materials and Use

A range of materials are used for sewer mains, such as vitrified clay, concrete, HDPE, and ductile iron pipes. The asset lives tend to vary depending upon the different materials, quality of materials, quality of installations and local

conditions such as ground conditions, temperature, external stress from traffic or ground movement. In general sewers are known to last for approximately 100 years unless subject to specific stress such as corrosion for concrete sewers in warm climates. Technologies for relining sewers have developed in the last 5-10 years such that it is often more effective to reline the sewers rather than replace them. The life of a relined sewer is not yet properly documented but can be taken as approximately 50 years. Sewer rising mains or pressure pipelines tend to have shorter asset lives, perhaps 80 years, at the end of which a zero residual value is recommended.

An estimate of the life of sewerage assets is presented in *Table 8.1*. In general mechanical/electrical equipment will have zero residual value. Sewers where the “right-of-way” is a significant asset have approximately 25% residual value and civil structures have a small residual value.

Table 8.1 Life of Sewerage Scheme Assets

Asset	Years*
Sewers	80 years
Pumping Stations – Civil	50 years
Pumping Stations - Mech/Elec	25 years
Treatment Plants – Civil	50 years
Treatment Plants - Mech/Elec	25 years
Treatment Plants – Control	15 years
Outfalls	80 years

* These are often set by the Government and once final cannot be changed for a particular asset.

8.4 Running (Operation and Maintenance) Costs

Include All Parts of Running Costs

The costs associated with the continued operation of a sewerage scheme relates to hiring of labour, maintenance of equipment, and purchase of electricity, water and chemicals. Again for each element of the scheme annual costs are required. The components of the annual running cost are as follows:

- ◆ Electrical costs - from power consumption and electrical tariff. A lack of separate metering of equipment often limits the assessment of power consumption and the breakdown of the costs.
- ◆ Labour costs - the total cost of labour used to operate and maintain the system. This should include the real costs to the organisation, actual wages and salary plus social costs and overhead costs.

- ◆ Equipment costs - the costs associated with equipment used - backhoes, drills, motors, vehicles, etc.
- ◆ Chemicals used in any process
- ◆ Disposal costs, for example in relation to sludges
- ◆ Routine maintenance costs
- ◆ Management costs
- ◆ Administrative costs often associated with regulation of the system (e.g. monitoring of plant performance and effluent discharge).

The critical point in determining the running costs is to ensure that all costs are included and these are checked against actual budgets. The running costs are incurred for many decades and hence they have a more important impact on the overall financial viability of a scheme in comparison to one off capital cost expenditures.

When estimating the O&M costs of sewerage treatment plant and sludge treatment plant, it should be noted that unit O&M cost per 1 PE must be always lower if the design PE of the facility is larger in a certain treatment plant under the same treatment system. For example, if the design PE of a treatment plant is assumed to be twice of that of the other plant, O&M cost of larger one is always less than twice of the smaller one if they utilize a common treatment system.

It is assumed that there are two options in a certain sub-catchment, that is, Option A and Option B. Option A plans to construct one centralized sewerage treatment plant with 90,000 design PE. Option B plans to construct 3 sewerage treatment plants with each 30,000 PE (total 90,000 PE). As unit O&M cost per PE for smaller treatment plant is higher, unit O&M cost per PE of 30,000 PE treatment plant (Option B) is higher than that of 90,000 PE treatment plant (Option A). As a result, total O&M costs of Option B must be larger than those of Option A. Therefore, under the common treatment system, total O&M costs of multipoint system must always be larger than those of centralized or regionalized system to serve for identical sewerage volume (design PE).

8.5 Net Present Value and B/C

Present Value is the Today Costs or Benefits for The Project

The net present value method is most commonly used for comparing the different Sewerage Management Strategies. This procedure essentially converts future costs and benefits into equivalent present day costs and benefits. Revenue and Expenditure Stream Table shall be prepared by filling up the expenses, revenues, and the balance for the project life (refer to Table 8.2). Project life, which is usually set at 30 to 40 years after the start of sewerage services, is the period that constructed sewerage facilities is considered to bear the revenues without the total renovation. Expenditures include construction costs, operation and maintenance costs, and replacement costs. Replacement costs cover the replacement of mechanical/electrical equipment, such as pumps. Replacement costs shall be

estimated by setting a certain percentage of capital expenditure. Revenues are the sewerage tariff revenues which shall be raised after the start of the sewerage services through the facilities planned by the Project.

Table 8.2 Revenue and Expenditure Stream of Option X of Sewerage Catchment Strategy
(Unit: RM in million)

Year	Expenditure				Revenue	Balance
	Construction	O&M	Replacement	Total	Total	
-2 2008						
-1 2009						
0 2010						
1 2011						
2 2012						
3 2013						
4 2014						
5 2015						
6 2016						
7 2017						
8 2018						
9 2019						
10 2020						
11 2021						
12 2022						
13 2023						
14 2024						
15 2025						
16 2026						
17 2027						
18 2028						
19 2029						
20 2030						
21 2031						
22 2032						
23 2033						
24 2034						
25 2035						
26 2036						
27 2037						
28 2038						
29 2039						
30 2040						

Note: In this table, construction period is assumed as 3 years from 2008 to 2010, corresponding to -2 to 0. 30 years project period is counted from 2011 when the service is planned to start.

In the project area where no existing sewerage infrastructure, it is easy to grasp the revenues and expenditures of the project. Actually, there are usually several existing sewerage facilities in the catchment area where strategy or plan is

prepared. In such a case, revenues and expenditures of the project to be filled in the Revenue and Expenditure Stream Table are found as follow;

- i) Grasp the Expenditures and Revenues “Without the project case”,
- ii) Calculate the Expenditures and Revenues “With the project case”,
- iii) Difference between “With the project case” and “Without the project case” shall be the Expenditures and Revenues of the project.

In other words, additional costs and additional tariff revenues by the project shall be put into the Revenue and Expenditure Stream Table. For example, when the expansion of STP is the option to be evaluated, Revenue and Expenditure Stream Table must include only the additional costs of operation and maintenance as well as construction costs and revenues from the additional customers served by expanded STP.

Trend of average billed amounts of sewerage charge per Person Equivalent (PE) is shown in Figure 8.1. The numbers on the figure reflects on the total billed amount and total PE of not only the domestic but also commercial, government, and industrial customers. The trend is almost stable with a slower increase. These data shall be used to estimate the annual revenue.

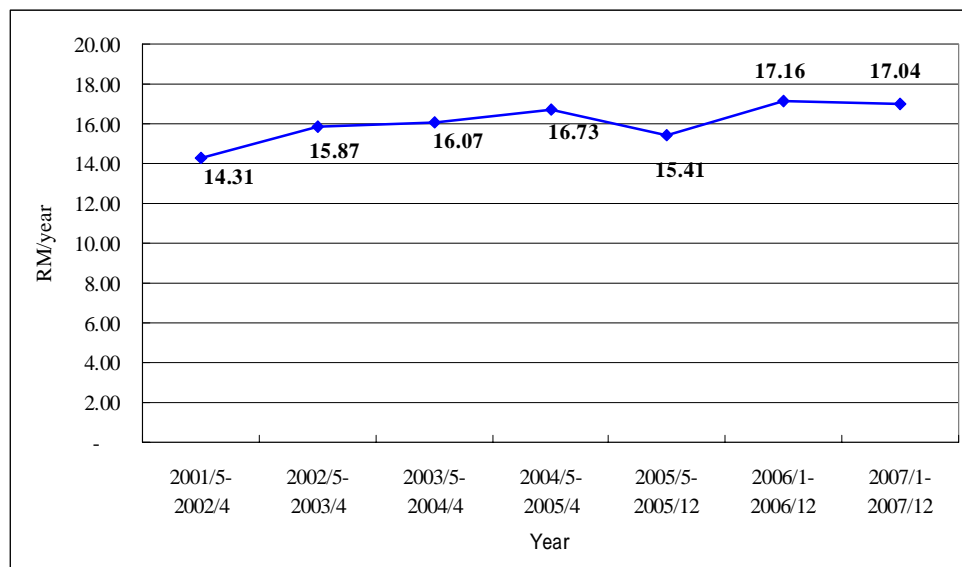

Note: Based on the Total PE and tariff billing data. Collection rate is not reflected on the above number. Relevant collection rate must be set for computing the revenues

Figure 8.1 Trend of Average Billed Amount of Sewerage Charge / PE

Net Present Value (NPV) shall be calculated for Balances of Expenditures and Revenues. Balances are often negative number for sewerage project, since the tariff revenues are short of necessary annual O&M costs in many cases. Negative NPV indicates that external money must be put on the project other than tariff revenues. Sewerage project which has bigger NPV (close to zero, in case of negative number) shall be given higher priority from the financial viewpoint. NPV is calculated by following formula;

$$NPV = \sum_{i=1}^n \frac{P_i}{(1+r)^{i-1}}$$

- i: Year from the start of the construction of the project. First line of the Revenue and Expenditure Stream table shall be counted as 1st year.
- n: Last year of project period from the start of the construction.
- r: Discount rate.
- P_i: Balance of expenditures and revenues of the year “i”, often the negative number for the sewerage project.

The actual value of the interest or discount rate should be set by the asset owner. As mentioned previously, different rates should be applied to different assets. For the purposes of planning, a single rate of 8% shall be used. Selection criteria of Priority Project by NPV evaluation is as follows;

If, NPV (Option A) > NPV (Option B) ,



Option A has higher priority from financial view point

Benefit Cost ratio (B/C ratio) is also used to compare the different Sewerage Management Strategies. B/C is to check the relative size of present value of Revenues comparing to present value of Expenditures. B/C for sewerage projects is often less than 1. If B/C of a certain project is close to 1, the project is considered to generate the same Benefit as Expenditure in present value bases. B/C is useful to compare some projects which differ so much in size of costs, since Net Present Value of balance tends to show small positive or negative numbers for the small size project. B/C is calculated by following formula;

$$B/C = \frac{\sum_{i=1}^n \frac{B_i}{(1+r)^{i-1}}}{\sum_{i=1}^n \frac{C_i}{(1+r)^{i-1}}}$$

- i: Year from the start of the construction of the project. First line of the Revenue and Expenditure Stream table shall be counted as 1st year.
- n: Last year of project period from the start of the construction.
- r: Discount rate.
- B_i: Revenues of the year “i”
- C_i: Expenditures of the year “i”

For the discount rate (r), same number shall be used as it is for NPV calculation. Comparing the B/Cs of some options, priority of them will be decided as follows;

If, B/C (Option A) > B/C (Option B) ,



Option A has higher priority from financial view point

- Financial Internal Rate of Return (FIRR) is often used to see the feasibility of the project. FIRR is, briefly speaking, the discount rate which makes the NPV zero. If the calculated FIRR of a certain project is more than the opportunity cost of capital (8%), the project is said to be financially feasible. It shall make positive profit through the project period by procuring the fund at that opportunity cost of capital. Generally speaking, in case of sewerage project, it is very difficult to make positive profit through the project period. In this case, FIRR can not be available. Therefore, it is NOT NECESSARY to check the FIRR for the catchment strategy/plan. For reference, FIRR is calculated using Microsoft Excel. Selection criteria of projects by FIRR is as follows;

	FIRR		Evaluation	
	Option A	Option B	Option A	Option B
Case 1	N.A.	N.A.	Not feasible without external budget input	Same as Option A
Case 2	$0 < \text{FIRR} < r$	N.A.	Not feasible without external budget input, but better than Option B	Not feasible without external budget input
Case 3	$\text{FIRR} > r$	$0 < \text{FIRR} < r$	Feasible without external budget input, Option A has higher priority.	Not feasible without external budget input
Case 4	$\text{FIRR} > r$	$\text{FIRR} > r$	Feasible without external budget input. Bigger the FIRR, more profitable the option.	Same as Option A

Note: N.A.; Not available.

r; Discount rate, or in other words, opportunity cost of capital.

The reliability of NPV estimation is dependent on the accuracy of projected costs and revenues. In practice operation and maintenance costs tend to be poorly documented and thus can influence on the accuracy of NPV comparisons. Options which have NPV values closer than 5% among them could be considered effectively the same. On the other hand if NPVs of Options differ by more than 10% to 20%, it is unlikely that an Option of lower NPV shall be selected from the financial point of view.

An example of the application of NPV analysis is discussed herewith. The objective is to assess the relative financial impact of two different options. Option A has a higher initial capital cost and moderate operating and replacement costs; whilst Option B has a lower capital cost with higher operating costs and lower replacement cost. Revenues are little larger in Option B. The Revenue and Expenditure Streams for both Options are shown in Table 8.3 and Table 8.4.

Table 8.3 Revenue and Expenditure Stream of Option A of Sewerage Catchment Strategy

(Unit: RM in million)

Year	Expenditure				Revenue	Balance
	Construction	O&M	Replacement	Total	Total	
0 2008	30.00	3.00		33.00	0.00	-33.00
1 2009		3.00		3.00	0.40	-2.60
2 2010		3.00		3.00	0.80	-2.20
3 2011		3.00		3.00	1.20	-1.80
4 2012		3.00		3.00	1.60	-1.40
5 2013		3.00		3.00	2.00	-1.00
6 2014		3.00		3.00	2.40	-0.60
7 2015		3.00		3.00	2.80	-0.20
8 2016		3.00		3.00	2.80	-0.20
9 2017		3.00		3.00	2.80	-0.20
10 2018		3.00		3.00	2.80	-0.20
11 2019		3.00		3.00	2.80	-0.20
12 2020		3.00		3.00	2.80	-0.20
13 2021		3.00		3.00	2.80	-0.20
14 2022		3.00		3.00	2.80	-0.20
15 2023		3.00	8.00	11.00	2.80	-8.20
16 2024		3.00		3.00	2.80	-0.20
17 2025		3.00		3.00	2.80	-0.20
18 2026		3.00		3.00	2.80	-0.20
19 2027		3.00		3.00	2.80	-0.20
20 2028		3.00		3.00	2.80	-0.20
21 2029		3.00		3.00	2.80	-0.20
22 2030		3.00		3.00	2.80	-0.20
23 2031		3.00		3.00	2.80	-0.20
24 2032		3.00		3.00	2.80	-0.20
25 2033		3.00		3.00	2.80	-0.20
26 2034		3.00		3.00	2.80	-0.20
27 2035		3.00		3.00	2.80	-0.20
28 2036		3.00		3.00	2.80	-0.20
29 2037		3.00		3.00	2.80	-0.20
30 2038		3.00	8.00	11.00	2.80	-8.20

NPV: -42.09 million Rs. B/C: 0.35 @ Discount Rate 8.00%

Table 8.4 Revenue and Expenditure Stream of Option B of Sewerage Catchment Strategy

(Unit: RM in million)

Year	Expenditure				Revenue	Balance
	Construction	O&M	Replacement	Total	Total	
0 2008	24.00	4.20		28.20	0.00	-28.20
1 2009		4.20		4.20	0.40	-3.80
2 2010		4.20		4.20	0.80	-3.40
3 2011		4.20		4.20	1.20	-3.00
4 2012		4.20		4.20	1.60	-2.60
5 2013		4.20		4.20	2.00	-2.20
6 2014		4.20		4.20	2.40	-1.80
7 2015		4.20		4.20	2.80	-1.40
8 2016		4.20		4.20	3.20	-1.00
9 2017		4.20		4.20	3.20	-1.00
10 2018		4.20		4.20	3.20	-1.00
11 2019		4.20		4.20	3.20	-1.00
12 2020		4.20		4.20	3.20	-1.00
13 2021		4.20		4.20	3.20	-1.00
14 2022		4.20		4.20	3.20	-1.00
15 2023		4.20	6.00	10.20	3.20	-7.00
16 2024		4.20		4.20	3.20	-1.00
17 2025		4.20		4.20	3.20	-1.00
18 2026		4.20		4.20	3.20	-1.00
19 2027		4.20		4.20	3.20	-1.00
20 2028		4.20		4.20	3.20	-1.00
21 2029		4.20		4.20	3.20	-1.00
22 2030		4.20		4.20	3.20	-1.00
23 2031		4.20		4.20	3.20	-1.00
24 2032		4.20		4.20	3.20	-1.00
25 2033		4.20		4.20	3.20	-1.00
26 2034		4.20		4.20	3.20	-1.00
27 2035		4.20		4.20	3.20	-1.00
28 2036		4.20		4.20	3.20	-1.00
29 2037		4.20		4.20	3.20	-1.00
30 2038		4.20	6.00	10.20	3.20	-7.00

NPV: **-47.14** million Rs.B/C: **0.35**

@ Discount Rate

8.00%

NPV of Option A is larger than that of Option B. Option A requires 42.09 million RM external budget input for project period in present value bases at 8% discount rate. B/Cs are the same for both Option A and Option B. Present value of Revenues is 35% of present value of Expenditures for both Option A and Option B. In this particular example, Option A is a better proposition financially than Option B. However technical and environmental factors have to be incorporated into the overall evaluation to arrive at a final decision on which Option is better suited to the set needs.

SECTION 9

Selection Of A Preferred Option

9.1 Introduction

The methodology for carrying out an in-depth analyses of a short listed number of viable or favoured options is briefly presented in this Chapter. The assessment initially encompasses the financial (cost), technical and environmental analysis of each option separately, before subjecting them to a composite ranking exercise employing objective weighting factors to emphasise on important criteria that could influence final selection based on overall merit.

As indicated before financial factors can be subjected to a quantitative analyses; whilst the comparative assessment of technical and environmental aspects related to each option can only be based on a semi-quantitative or qualitative approach.

9.2 Collation Of Pertinent Information

Presentation of Basic Information Prior to Evaluation

The basic information needed for a comparative assessment of favoured options should preferably be summarised in pictorial and tabular fashion.

For *each option* the following should be highlighted, viz:

- ◆ A diagrammatic representation of the principal routing and sizing of trunk sewers, the locations of pump stations and sewage treatment plants and the location of discharge of the treated effluent (Refer to *Figures 9.1 and 9.2*).
- ◆ A tabulation of:
 - Lengths of various diameters of sewer pipes and their respective average depths.
 - The plot size and capacity of pump stations that shall be implemented in stages over the Planning Period. The estimated total dynamic head against which sewage has to be pumped should also be indicated at each planning stage.
 - The number, areal size, type and capacity of STPs that shall be implemented at various stages throughout the Planning Period.
 - The length, size and capacity of outfall pipes conveying treated effluent to a receiving water course.

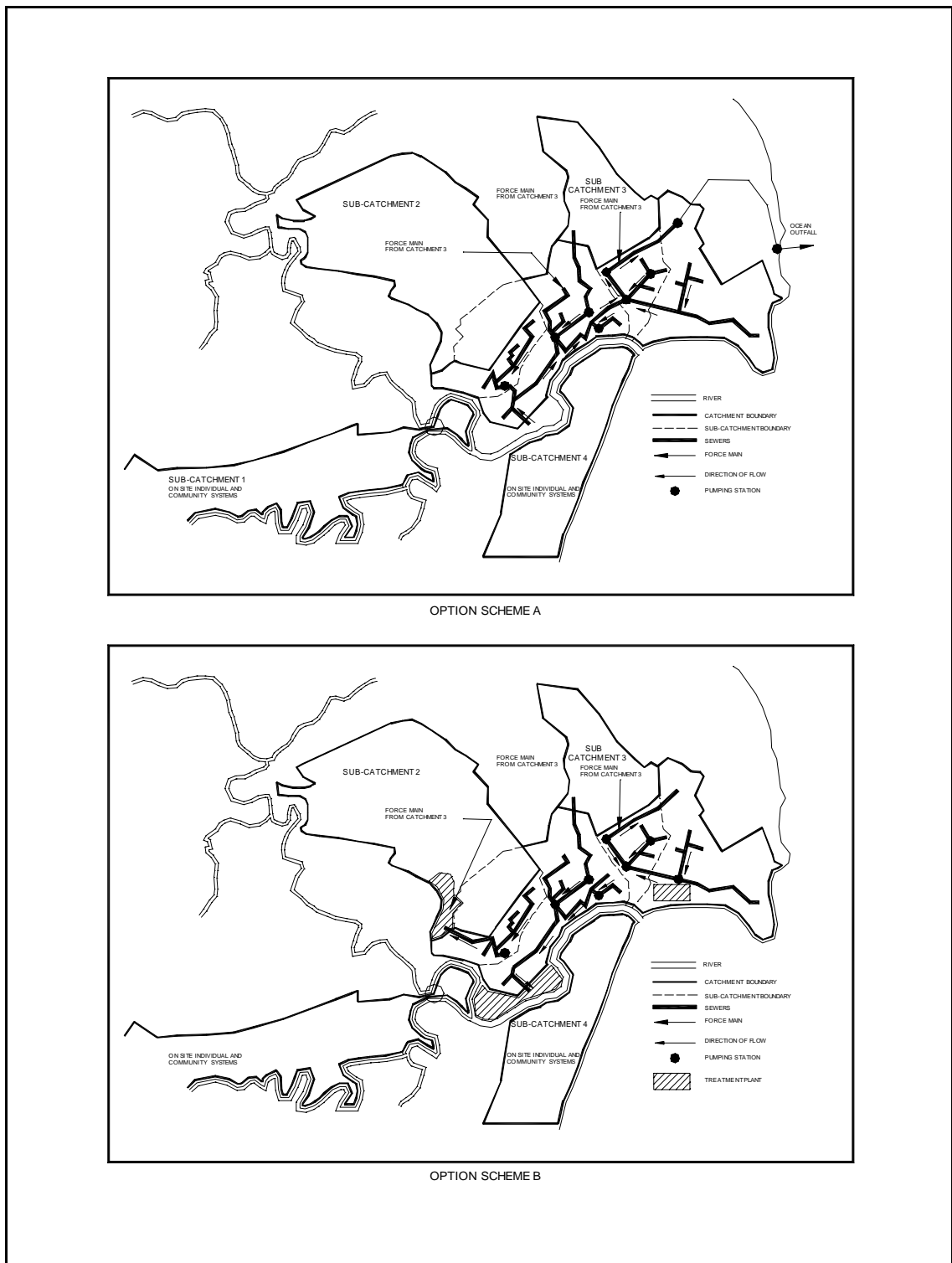

Figure 9.1 Option Scheme A & B

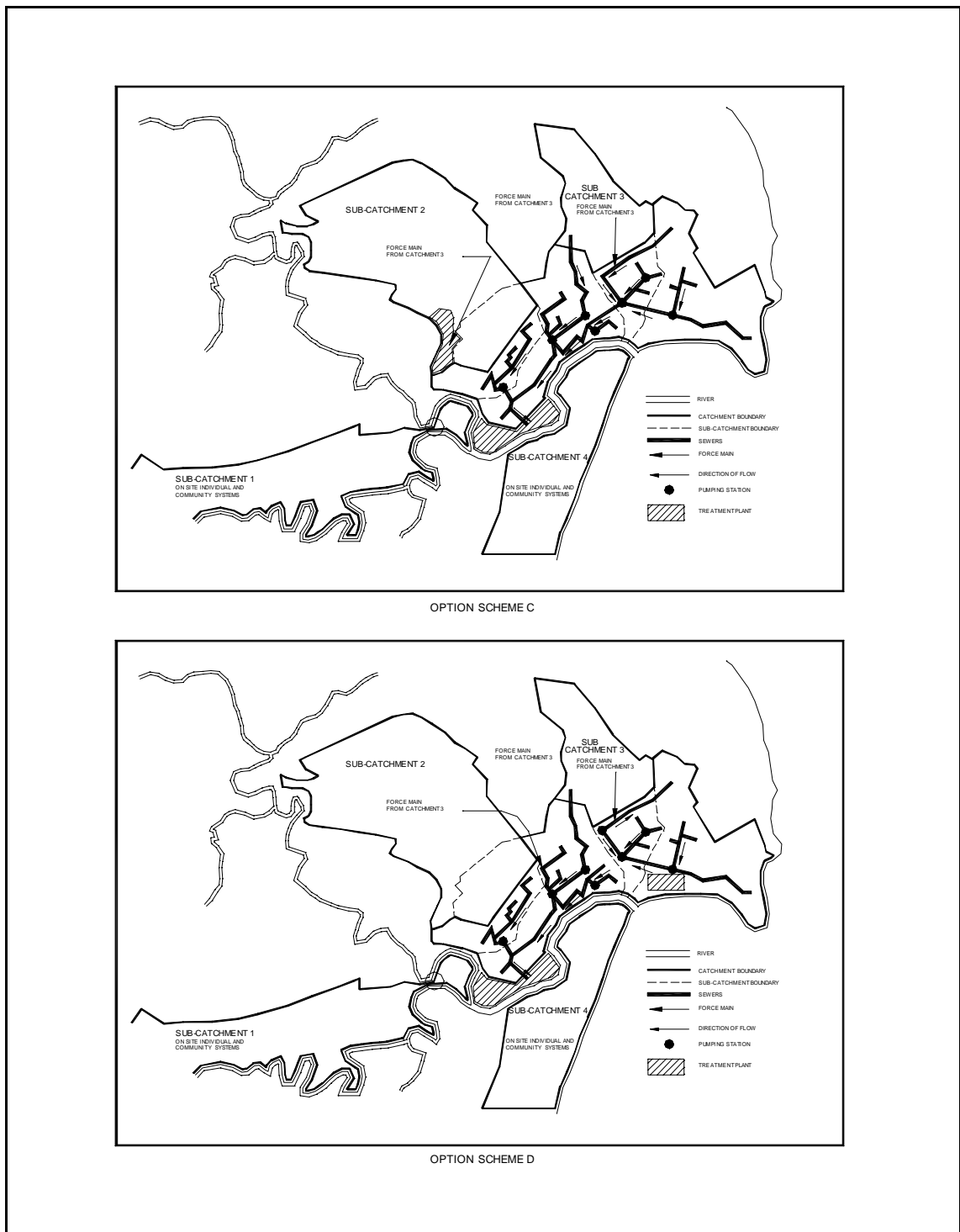

Figure 9.2 Option Scheme C & D

It is important that a fairly detailed attempt at staging the implementation of facilities be carried out for each option. In this respect it would be advisable to have each stage lasting for a period of five (5) years. Hence for a planning period extending for twenty (20) years, there shall be four (4) discrete stages where progressive implementation of facilities and expansion and upgrading of sewerage services can be pursued with. The total capital and running costs for each stage should then be identified. For a more detailed analysis, the yearly distribution of capital and running costs over a particular staging period can be presented. The costs portrayed over the entire planning period should be computed based on base year estimates without factoring in inflation. Allowances for depreciation costs and residual asset values may or may not be factored into the overall financial picture. However costs related to purchase of land should be included in the overall analysis.

It is also important that items common to all options (e.g. reticulation sewers) be identified and excluded from technical, financial and environmental analysis.

9.3 Evaluation Based on Financial Considerations

NPV Analysis and Capital and Operation and Maintenance Cost Schedules

Balance of revenues and expenditures for each option spread over the Planning Period is subjected to Net Present Value (NPV) analysis based on a specified discount (or interest) rate that is reflective of the present (commercial) market rate for borrowing of funds. The findings from NPV comparison are summarised in the following manner, viz:

Option	Comparative Total Net Present Value of Balance (RM Million)
A	-73.4
B	-89.1
C	-93.3
D	-82.1

For the above situation, option A will be selected as the preferred option based on the financial evaluation. Evaluation based on technical consideration is also conducted for all of the options. On the other hand, it is important to emphasise on first stage capital cost expenditures. This is because first stage costs represent a realistic investment to meet predictable capacity requirements over the short term. Cost breakdown of the selected preferred option shall be described as shown in the Table 9.1.

Table 9.1 Summary Of Comparative Cost Analysis Option

		Cost Constant 2007 RM(Thousand)			
		Stage 1 0 - 5	Stage 2 6 - 10	Stage 3 11 - 15	Stage 4 16 - 20
System Elements					
(i)	Sewer Limes				
	(a) Capital Cost	15,600	8,200	4,400	1,100
	(b) Present Worth	15,600	5,100	1,700	300
	(c) Annual Operation and Maintenance Cost	58	88	104	108
	(d) Present Worth	200	200	200	100
(ii)	Pump Station and Appurtenances				
	(a) Capital Cost	3,500	4,600	8,200	3,600
	(b) Present Worth	3,500	2,800	3,100	900
	(c) Annual Operation and Maintenance Cost (Electricity, Chemical & Repair etc.)	56	145	401	441
	(d) Present Worth	200	300	600	400
(iii)	Treatment Plants (Including Bio-solid Treatment)				
	(a) Capital Cost	18,200	-	16,600	-
	(b) Present Worth	18,200	-	6,400	-
	(c) Annual Operation and Maintenance Cost (Electricity, Chemical & Repair etc.)	110	190	352	370
	(d) Present Worth	400	500	500	300
(iv)	Land				
	(a) Capital Cost	11,900	-	-	-
	(b) Present Worth	11,900	-	-	-
Total Comparative Cost by Stage Present Worth		50,000	8,900	12,500	2,000
Total For All Stages Present Worth		75,400			

9.4 Evaluation Based on Technical Considerations

The evaluation of options based on technical considerations is semi-qualitative, but the weights placed for the criterion are essentially subjective.

In this evaluation, the following quantitative criteria are re-evaluated for the listed options.

- ◆ Discharged Pollution Load
- ◆ Discharged Pollution Load/Area
- ◆ Reduced Pollution Load
- ◆ Reduced Pollution Load/Capital Cost
- ◆ Reduced pollution Load/ Net Present Value

In addition to the above, non-quantitative criteria are evaluated, as discussed below.

- ◆ **Adaptability**

Adaptability relates to how flexible an Option is in relation to under or over estimation of system component capacities during the latter stages of the Plan; and to changing effluent discharge standards and criteria for design of safe systems.

- ◆ **Operability and Maintenance**

Operability and Maintenance relates more on how much skill an Option will require for the operation and maintenance of the sewerage system. For example, when the treatment plant is a membrane biological reactor, high quality effluent is expected but the system will get a low score on Operability and Maintenance because high skilled operators are required. On the other hand, an oxidation pond has lower grade treated water quality but gets a high score for O&M because required operator skill level is low.

9.5 Evaluation Based on Environmental Considerations

In sewerage planning, usually the more important environmental issues are:

- ◆ water quality as it is affected by discharge of treated sewage
- ◆ Reduction of Pollution load
- ◆ aesthetics (e.g. visual appearance, noise, odours, etc.) as affected by sewage pumping and treatment facilities, and by treated effluent disposal

- ◆ effects of construction on the natures such as rare wildlife
- ◆ effects resulting from construction activities such as noise, dust, soil erosion, disruption of traffic and access to business and public inconvenience
- ◆ necessary commitments of resources such as manpower, energy and construction materials.

9.6 Overall Assessment and Selection of Preferred Option

Overall Assessment

In the overall assessment of Options, financial and non-financial aspects of each Option have to be weighed against each other to arrive at a comprehensive weighted ranking of the alternatives available.

If all of the options have similar technical and environmental impacts or consequences, then the NPV will tend to be used for selection of a preferred option. In practice the most critical of non financial factors tend to be those which permit a flexible approach to the construction and operation of facilities. Clearly any option that meets all of the environmental conditions including bio-solid and effluent quality, and allows decisions on total capacity installation to be deferred will be favoured. The nature of all planning activities is that there is a greater probability of accuracy predicting the required capacity over the short term (< 5 years) rather than over the medium to long term. Hence deferring a decision while meeting all statutory requirements means that any installed capacity is likely to be close to actual requirements.

Comparison of Financial and Non-Financial Factors

There is no simple method of comparing the financial and non financial factors. Clearly, if an Option has the lowest NPV and is similar on all other criteria it will be preferred. If the lowest financial option has several disadvantages when compared to more expensive options the views of IWK and DGSS have to be taken into account in making a final selection. It should be remembered that the costing information cannot be accurate, all of the planning methodology assumes that the costing is at least self consistent.

The only method of directly comparing financial and non financial factors is to ascribe a weighting to costs. For example *Table 9.2* describes such an analysis. The difficulties of this approach is in allocating the relative importance of the criteria. In general this needs to be established prior to the analysis and needs to be agreed by DGSS. The marking system then needs to be defended. Often the lowest cost is given the maximum score (25 for Option 4 in *Table 9.2*); more expensive options are then marked on a pro rata basis based upon NPV. Inevitably it is more difficult to give quantitative measures for non financial criteria.

Cost Tend to Receive High Weighting

Typically the range of marks is constrained with no option receiving full marks for a non financial criteria and options rarely scoring less than 50% of the maximum value. The net effect of this is to substantially increase the real weighting given to financial factor. Financial issues probably represents nearer 50% of the weighting. Hence, while the comparison can be undertaken the limitations of the approach need to be understood.

Table 9.2 Assessment of Options

Criteria		No1	No2	No3	No4	No5
	Maximum Score	Centralise at One Plant	Build One New Plant with Bio-solid Facilities, Plus retain 2 Plants	Upgrade Four Plants Local Effluent and Bio-solid Reuse	Two Plants, Two Bio-solid Facilities	Construct Two Plants One Central bio-solid Facility
Discharged Pollution Load, Kg as BOD/d	15	15	6	9	6	10
Discharged Pollution Load/Area, kg as BOD/d/Km ²	5	5	3	3	3	3
Reduced Pollution Load, Kg as BOD/d	15	15	9	9	6	6
Reduced Pollution Load/Capital Cost, kg as BOD/d/RM	15	9	5	9	9	9
Reduced pollution Load/NPV, kg as BOD/d/RM	10	8	5	5	3	5
Capital Cost, RM	10	6	6	8	3	3
Adaptability	5	3	3	3	3	3
Operability & Maintenance	5	4	3	3	3	3
Effect of Construction on Wildlife	15	10	8	8	8	8
Disposal bio-solid Quantity	5	4	2	4	4	4
Total	100	79	50	61	48	54

Based on *Table 9.2* the Options can be ranked in order of preference with the highest score in this case being the most preferred Option.

9.7 Optimisation of Preferred Option

The preferred option selected from a consideration of the financial and non financial factors should be examined in more detail to identify possible problems with the option and to optimise the option. This will be carried out at the concept and detail design stages of the scheme. However, a preliminary examination based upon information gathered at this planning stage is beneficial. The most important aspects to analyse are:

Develop Improvements To Preferred Option

Staging the work - when the sewers and treatment units should be constructed.

Integration of the work with anticipated changes in regulation for example of effluent quality or bio-solid characteristics.

Details of the methods of processes to be used to rehabilitate sewers or to upgrade treatment plants.

A programme for staged installation of facilities under the Catchment Plan should be evolved. An example is given in *Figure 9.3*. The estimated staged components cost of installing facilities should also be summarised as in *Table 9.3*.

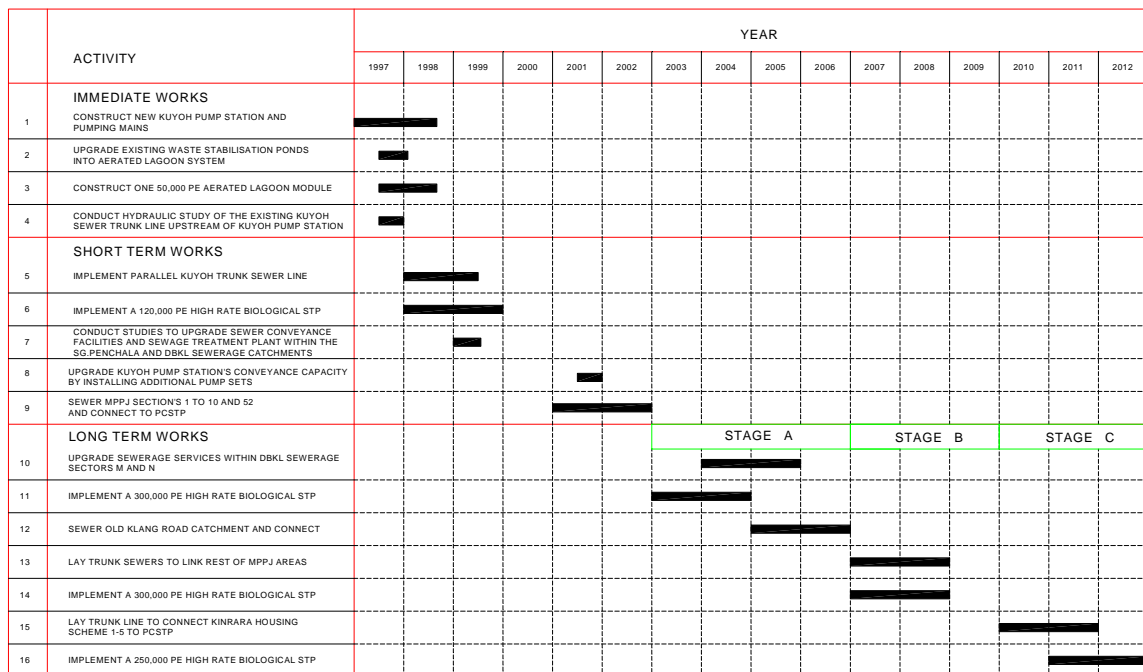

Figure 9.3 Puchong Sewerage Zone – Master Plan Implementation Programm

Table 9.3 Estimated Costs For Staged Implementation Works

Recommended Works	Implementation Period	Cost Estimates (RMx10⁶)
IMMEDIATE TEAM (1996 TO 1999)		
Implement New Kuyoh Pump Station and Force Mains	November 1996 to August 1997	21.20
Upgrade Existing WSPs to Aerated Lagoons	July 1997 to January 1998	3.50
Construct 50,000 PE Aerated Lagoon Module	July 1997 to September 1998	7.50
Conduct Detailed Hydraulic Study of the KSTL and PGSTL	July 1997 to December 1997	0.50
Sub-Total		32.70
SHORT TERM (1998 TO 2000)		
Implement Parallel Kuyoh Sewer Trunk Line	January 1998 to June 1999	26.40
Construct a 120,000 PE HRBTM capable of Producing a Standard A Effluent	January 1998 to December 1999	48.00
Conduct Feasibility Study on Upgrading Sewerage Service Within Sewerage Sectors M and N	January 1999 to July 1999	0.40
Sewer MPPJ Sections 1 to 10 and Connect Up to PCSTP	January 2001 to December 2002	31.50
Upgrade KPS to 2784l/sec Pumping Capacity	June 2002 to December 2002	1.40
Sub-Total		107.70
LONG TERM (2000 TO 2012)		
Construct a 300,000 PE HRBTM Capable of Producing a Standard A Effluent	January 2003 to December 2004	105.00
Sewer Old Klang Road Service Area and Connect to PCSTP	January 2005 to December 2006	27.15
Upgrade Sewerage Services Within Sewerage Sectors M and N	January 2002 to December 2003	15.00
Link Up Western Sector of Sg.Penchala Catchment to PCSTP	January 2007 to December 2008	62.85
Construct a 300,000 PE HRBTM Capable of Producing a Standard A Effluent	January 2007 to December 2008	105.00
Connect Kelang Sewerage Sector to PCSTP	January 2010 to December 2011	13.80
Construct a 250,000 PE HRBTM Capable of Producing a Standard A Effluent	January 2011 to December 2012	87.50
Sub-Total		416.30
Grand Total		556.70

APPENDIX A

Sources of Information

A1 Potential Services of Basic Information

As part of the Catchment planning process it is necessary to liaise with relevant organisations, both public and private, as well as with knowledgeable individuals who can be expected to provide information on the area; and who have an interest in, or are affected by, the current sewerage system or future sewerage strategy. Interested parties would include:

- ◆ The Public, who is paying for the services
- ◆ The Federal Government, e.g.
 - The Treasury
 - The EPU (State and Federal)
 - JPP - Jabatan Perkhidmatan Pembentungan
 - JKR - Jabatan Kerja Raya
 - JPN - Jabatan Perumahan
 - JAS - Jabatan Alam Sekitar
 - JPS - Jabatan Pengairan dan Saliran
- ◆ State Governments
- ◆ State Planning Departments
- ◆ State Land Offices
- ◆ [Pejabat Pos](#)
- ◆ Local Authorities (There are about 144 LA's in Malaysia)
- ◆ The Land Developers (Private and Public)
- ◆ Other utility Bodies, e.g. TNB, STM, JBA, IWK
- ◆ Specific interest groups e.g. groups or organisations that use a particular area for recreation.
- ◆ Non Government Organisations that have an interest relevant to sewerage or affected areas of the catchment, e.g. environmental organisations.

APPENDIX B

Qualification and Quantification of Sewage Flow Pollutant Load Characteristics

B1 Introduction

In this Appendix a more detailed description is presented on sewage flow characteristics and their quantification, the estimation of pollutant loads conveyed in sewage, and the derivation of bio-solid loads produced during treatment of sewage.

The following documentary is meant to present more substantive information on the salient facts presented in *Chapter 5* of this Manual.

B2 Sewage Flows

Sewage Flow Variations

Sewage flows conveyed in pipe lines are not constant but vary considerably over a day; i.e. they exhibit diurnal variations. The extent of variation will be dependent on the Population Equivalent Count level served, and on the extent of sewage discharges from commercial, industrial and institutional premises located within a specific area, or over an entire Catchment. It is normally expected that higher rates of sewage flows shall prevail during the early mornings (6 am to 8 am), when man's body cleansing, food preparation and utensil cleansing activities peak. Particularly low rates of flow occur usually in the very early mornings (i.e. 3 am to 5 am) when man is usually at rest. This variation in flows is an important factor as it dictates the sizing of sewers and sewage treatment plants.

As can be expected the average daily rate of sewage flow generation is also dependent significantly on the socio-economic status of a community, particularly with respect to its affluence, standard of living, income generation and availability of wholesome piped water supplies.

Per Capita Flow Rate Concept

The Malaysian Sewerage Code of Practice recommends that for sewerage design purposes it can be assumed that a single person resident within a Catchment Area generates an average daily sewage flow of 225 litres per day. This average unit rate, which can be assumed to be valid for the next 20 to 25 years (i.e. paralleling the asset life of a sewerage facility), is also termed as *the per capita sewage contribution rate*.

Validity of a Constant Per Capita Sewerage Generation Rate

The validity for assuming a constant per capita sewage generation rate throughout a long term Planning Period may be questioned. For example experience in other countries suggests that as per capita incomes increase; the following "knock-on" effects are induced, viz:

- ◆ There is an increasing use of water using equipment such as automatic washing machines and dish washers, leading to increased per capita sewage flows.

- ◆ Greater affluence tends to lead to greater water use and greater wastage of materials to the sewers.

Hence if there is a valid justification to vary the per capita sewage flow rate throughout a Planning Period this can be factored into the overall ADWF projections. However it should be mentioned that the manner by which commercial, institutional and industrial sewage flow generation rates are derived already leads to some over estimation of sewage flow rates by a specific Study Area.

Unit Rates of Sewage Flow from Different Types of Premises

Average daily sewage generation rates by individual premises or establishments are estimated by multiplying the per capita sewage flow generation rate by an appropriate factor termed as the *Population Equivalent* (PE) count. The Malaysian Standard MS1228 - Code of Practice for Design and Installation of Sewerage Systems - has recommended the use of specific values of Population Equivalents for different types of establishments. These are reproduced in *Table B.1* below.

Table B.1 Recommended Population Equivalent Factors

Type of Premise/Establishment	Population Equivalent (recommended)
Residential	5 per house
Commercial (includes offices, shopping complex, entertainment/recreational centres, restaurants, cafeteria, theaters)	3 per 100 m ² gross area
Schools/Educational Institutions:	
- Day schools/institutions	0.2 per student
- Fully residential	1 per student
- Partial residential	0.2 per student for non residential student and 1 per student for residential student
Hospitals	4 per bed
Hotels (with dining and laundry facilities)	4 per room
Factories (excluding process water)	0.3 per staff
Market (wet type)	3 per stall
Petrol Kiosks/Service Stations	18 per service bay
Bus Terminal	4 per bus bay
Taxi Terminal	4 per taxi bay
Mosque	0.5 per person
Church/Temple	0.2 per person
Stadium	0.2 per person
Swimming Pool/Sports Complex	0.5 per person
Public Toilet	16 per wc
Type of Premise/Establishment	Population Equivalent (recommended)
Airport	0.2 per passenger 0.3 per employee
Laundry	10 per machine
Prison	1 per person
Golf Course	20 per hole

For example, to estimate the average daily sewage generation rate from 1000 Residential Households, or from a Hospital with 100 beds, the following calculations are made, viz:

$$1000 \text{ households} \times 5 \text{ PE/Household} = 5,000$$
$$(\text{Total Population Equivalent Count}) \times 225 \text{ litres/day} = 1,125,000 \text{ litres/day}$$

$$100 \text{ beds} \times 4 \text{ PE/bed} = 400$$
$$(\text{Total Population Equivalent Count}) \times 225 \text{ litres/day} = 90,000 \text{ litres/day}$$

Hence a Catchment's, or its sub-area's, total daily average sewage generation rate at a particular time frame can be predicted by (a) inventorising all existing forms of occupied establishments, (b) grouping them under specific types of premises, (c) ascertaining their occupancy rates, (d) applying the relevant PE factors to individual groups in order to calculate their contributing Population Equivalent Count and corresponding sewage flows (by multiplying by 225 litres), and finally (e) totalling all the contributing PE counts or corresponding flows from a particular catchment sub-area, or from its total area.

A PE count is a convenient measure or indication of the magnitude of sewage flows and corresponding pollutant loads generated by a specific area, or which is conveyed in a sewer system or treated at a STP.

The total estimated Population Equivalent Count contributed by a specific area can also be employed to estimate the amount of area that is required to establish a STP capable of treating the corresponding sewage flows. The DGSS has derived specific guidelines to facilitate this estimation (Refer to *Appendix D*).

Extraneous Flows

There is a tendency, however for all sewerage systems laid below ground to experience some form of infiltration and inflows. These are generally termed as *extraneous flows*, and are generally composed of ground water, surface run-offs and rain water collected by roofs of dwellings. Extraneous flows are undesirable as they occupy valuable space within a sewerage and sewage treatment plant system; a factor which contributes to some form of over sizing with associated cost implications.

Estimation of Extraneous Flows

There are a number of different forms of empirical formulae that can be employed to estimate the amount of extraneous flows that should be catered for in a sewerage system. They are either expressed (a) in terms of areal coverage of a sewer network (litres/hectare), (b) with respect to the diameter and length of a sewer line, or (c) in terms of a percentage of the ADWF conveyed by a sewer system. Judgment is required in the selection of an appropriate formulae, and with respect to the selection of its numerical constants. The selection of appropriate numerical constants should take into consideration (a) how old the sewer line is and its method of jointing, (b) location of the sewer line (i.e. whether it is near a river or stream, whether the ground water depth over the pipeline is high or low,

and the sub-soil characteristics in which it is buried, etc.), and (c) the quality of construction of sewer lines, manholes and individual connections.

Studies carried out in Kuala Lumpur have revealed that the amount of extraneous flows in a sewer line can vary widely, from as low as 15% to as high as 100% of the ADWF.

Peak Wet Weather Flows (PWWF)

The rate of sewage flow discharged by a single person or from an individual household or from other premises will vary appreciably over a day. The infiltration of extraneous flows, especially during rainy periods, can also enhance the rate of sewage flows over a certain period of time. A sewer pipe line should be sized to convey the maximum rate of sewage flows that are discharged into it. To cater for this condition a *Peak Flow Factor*, defined as the ratio of the maximum instantaneous flow rate to the average daily flow rate is usually estimated.

Extensive studies have shown that as the sewage contributing population of a sewer line gets larger, or as the total PE Count becomes larger, the peaking factor or Peak Flow Factor becomes lower in magnitude. A wide range of empirical formulae have been developed to quantitatively describe the relationship between the *Peak Flow Factor (PFF)* and the population served (usually expressed as the cumulative Population Equivalent Count). The Malaysian Standard MS1228 - Code of Practice Design and Installation of Sewerage Systems - recommends the use of the following empirical equation, viz:

$$PFF = 4.7/[PE/1000]^{0.11}$$

The PFF as calculated by the above expression takes into account the presence of extraneous flows in the system. The validity of this predictive equation has yet to be verified. Use of other expressions can be permitted as long as their validity can be attested (e.g. by direct flow monitoring of an existing sewerage system within the subject catchment or in another catchment exhibiting similar development characteristics).

B3 Pollutant Loads

Average Pollutant Concentration

The common forms of pollutants present in medium strength domestic sewage, together with their corresponding concentrations, are summarised in *Table B.2* below:

Table B.2 Typical Composition of Domestic Sewage

Constituent	Concentration (mg/l)
Solids, total:	720
Dissolved, total	500
Fixed	300
Volatile	200
Suspended, total	220
Fixed	55
Volatile	165
Settleable solids, ml/l	10
Biochemical Oxygen Demand, 5-day, 20°C (BOD ₅ , 20°C)	220
Total Organic Carbon (TOC)	160
Chemical Oxygen Demand (COD)	500
Nitrogen (total as N):	40
Organic	15
Free ammonia	25
Nitrites	0
Nitrates	0
Phosphorus (total as P):	8
Organic	3
Inorganic	5
Chlorides	50
Alkalinity (as CaCO ₃)	100
Grease	100

Although the above concentration values are generally higher than that measured in most sewage discharges to treatment plants in Malaysia, they may be employed to conservatively estimate future pollutant loadings to treatment plants.

Per Capita Pollutant Loads

In revising guideline Vol.4, the following percapita contribution rate of some priority pollutants are proposed based on a per capita sewage generation rate of 225 litres/per day:

Pollutant	Value (g/capita.d)	Value (mg/l)
Biochemical Oxygen Demand (BOD ₅)	56	250
Suspended Solids (SS)	68	300
Chemical Oxygen Demand (COD)	113	500
Total Nitrogen (TN)	11	50
Ammoniacal nitrogen	7	30
Total Phosphorus (TP)	2	10
Oil and Greas (O&G)	11	50

As in the case of sewage Flows, inherent pollutant loads may increase in the future due to changed diet habits (e.g. consumption of more processed foods), and use of kitchen wash basin grinders for more convenient disposal of scrap food and vegetables. In addition increased use of household chemicals such as detergents, disinfectants and cleaning agents can release more of less degradable materials to sewers and hence to sewage treatment plants. These trends all lead to high pollutant loads per capita. The increased stress on environmental protection and resource conservation, combined with pricing signals as user pays for water, can slow or reverse these trends. For each area judgments are needed to determine the unit pollutant load generation figures to be used.

B4 Bio-solid Characteristics

Bio-solids produced by Septic Tanks and Imhoff Tanks are generally dilute in nature depending on the frequency of desludging. Their solids content could vary from 2 to 8 percent. Their organic and pathogenic bacterial content are also high. Hence these bio-solids need some form of stabilisation (i.e. reduction of organic matter and bacterial counts) and dewatering before they can be safely discharged to the environment.

Bio-solids produced by high rate biological sewage treatment plants are generally well stabilised and in certain cases sufficiently dewatered (> 20% solids). Hence they can be transported directly to disposal centres without further treatment. Small package plants however produce a well stabilised bio-solid that is very diluted (1 to 3% solids content). Hence they need to be dewatered at least 20% solids before they can be disposed to the environment.

Bio-solid produced in biological pond systems are generally stored in-situ for a considerable period. They are generally removed only when they occupy a significant proportion of the volume of the pond, and when the suspended solids of pond effluents rise appreciably. Their removal and disposal presents a significant problem.

B5 Factors Considered In Predicting Population Growth

The following factors were identified as likely to affect future population growth in the Pantai Sewerage Catchment (located within Dewan Bandaraya Kuala Lumpur).

- ◆ The relatively high economic growth that had occurred in the past 5 years.
- ◆ The construction of high rise condominiums and flats within the Pantai Catchment that would have mitigated previous scarcity in housing stock.
- ◆ The comprehensive extent of road networks which have been built that enable people working within Kuala Lumpur to reside in other neighbouring municipalities/districts.
- ◆ The scarcity of land for residential development unless rezoning of other land areas and upgrading of current residential land uses are adopted.
- ◆ The relocation of 75,000 Government workers to Putrajaya by year 2005 and the provision of 31,000 units of housing at Putrajaya to accommodate these people. In this context it is anticipated that probably 50% of households associated with the relocation would actually reside in Putrajaya, whilst the rest would commute from Kuala Lumpur on a daily basis.
- ◆ The tendency to disperse future commercial and industrial growth to areas outside of the Klang Valley in the long term.

APPENDIX C

Estimation of Sewage Treatment Plant Plot Areas

C1 Empirical Estimates of Areal Requirements for Different Types of Sewage Treatment Plants

This Appendix presents three (3) tables which introduces an empirical approach for estimating areal requirements for specific types of Sewage Treatment Plants.

Areal estimates employing this empirical approach can be employed to demarcate areas to be set aside for sewage treatment within a Catchment.

Table C.1 Land Area Requirements for Class 1 and 2 Plants

Population Equivalent	Land Area Requirement*	
	(m ²)	(acre)
100	210	0.052
150	285	0.070
200	360	0.089
250	430	0.106
300	485	0.120
350	545	0.135
400	600	0.148
450	655	0.162
500	700	0.173
550	745	0.184
600	790	0.195
650	835	0.206
700	870	0.215
750	905	0.224
800	940	0.232
850	980	0.242
900	1,010	0.250
950	1,040	0.257
1,000	1,070	0.264
1,100	1,115	0.276
1,200	1,160	0.287
1,300	1,200	0.297
1,400	1,240	0.306
1,500	1,275	0.315
1,600	1,310	0.324
1,700	1,340	0.331
1,800	1,370	0.339
1,900	1,395	0.345
2,000	1,420	0.351

*The required area does not include any buffer zone surrounding each plant. Appropriate setbacks and access paths within the plant have been included. (Source: Guidelines for Developers Volume IV : Published by Sewerage Services Department, Ministry of Housing and Local Government)

Table C.2 Land Area Requirements for Mechanised Class 3 to 6 Plants

Population Equivalent	Standard A*		Standard B*	
	(ha)	(acre)	(ha)	(acre)
2,000	0.17	0.42	0.17	0.42
3,000	0.22	0.55	0.22	0.55
4,000	0.27	0.66	0.27	0.66
5,000	0.31	0.76	0.31	0.76
10,000	0.78	1.93	0.66	1.63
15,000	1.00	2.47	0.84	2.09
20,000	1.19	2.95	0.99	2.44
25,000	1.37	3.38	1.13	2.79
30,000	1.53	3.79	1.26	3.11
35,000	1.81	4.48	1.65	4.08
40,000	1.97	4.88	1.79	4.43
45,000	2.12	5.25	1.93	4.77
50,000	2.23	5.52	2.03	5.02
55,000	2.37	5.84	2.15	5.31
60,000	2.52	6.22	2.29	5.66
65,000	2.67	6.61	2.43	6.00
70,000	2.93	7.23	2.66	6.57
75,000	3.27	8.07	2.82	6.96
80,000	3.49	8.61	3.03	7.49
85,000	3.69	9.12	3.23	7.99
90,000	3.89	9.61	3.42	8.46
95,000	4.07	10.06	3.60	8.90
100,000	4.25	10.49	3.77	9.32
110,000	4.57	11.29	4.09	10.10
120,000	4.87	12.02	4.38	10.81
130,000	5.14	12.70	4.64	11.47
140,000	5.39	13.32	4.89	12.08
150,000	5.63	13.90	5.12	12.64
160,000	5.84	14.44	5.33	13.17
170,000	6.05	14.95	5.53	13.67
180,000	6.25	15.43	5.72	14.14
190,000	6.43	15.89	5.90	14.58
200,000	6.60	16.32	6.07	15.00
250,000	7.36	18.20	6.81	16.83
300,000	7.98	19.73	7.41	18.32
450,000	9.36	23.14	8.76	21.65

*The required area does not include any buffer zone surrounding each plant. Appropriate setbacks and access paths within the plant have been included. (Source: Guidelines for Developers Volume IV : Published by Sewerage Services Department. Ministry of Housing and Local Government)

Table C.3 Required Land Area for Stabilisation Pond and Aerated Lagoon

Population Equivalent	Standard A*		Standard B*	
	(ha)	(acre)	(ha)	(acre)
2,000	0.48	1.18	0.45	1.10
3,000	0.69	1.69	0.59	1.45
4,000	0.89	2.20	0.71	1.75
5,000	1.09	2.68	0.82	2.04
10,000	2.03	5.01	1.31	3.24
15,000	2.92	7.2	1.72	4.25
20,000	3.78	9.3	2.09	5.16
25,000	4.62	11.4	2.42	5.99
30,000	5.45	13.5	2.74	6.77
35,000	6.26	15.5	3.04	7.50
40,000	7.05	17.4	3.32	8.2
45,000	7.85	19.4	3.59	8.9
50,000	8.63	21.3	3.86	9.5
55,000	9.40	23.2	4.11	10.2
60,000	10.16	25.1	4.36	10.8
65,000	10.92	27.0	4.90	11.4
70,000	11.68	28.9	4.83	11.9
75,000	12.42	30.7	5.06	12.5
80,000	13.17	32.5	5.28	13.1
85,000	13.91	34.4	5.50	13.6
90,000	14.64	36.2	5.72	14.1
95,000	15.37	38.0	5.93	14.6
100,000	16.10	39.8	6.13	15.2
110,000	17.54	43.3	6.54	16.2
120,000	18.97	46.9	6.93	17.1
130,000	20.38	50.4	7.31	18.1
140,000	21.79	53.8	7.69	19.0
150,000	23.18	57.3	8.05	19.9
160,000	24.57	60.7	8.40	20.8
170,000	25.95	64.1	8.75	21.6
180,000	27.32	67.5	9.09	22.5
190,000	28.68	70.9	9.43	23.3
200,000	30.04	74.2	9.76	24.1

* The required area for pond systems does not include any buffer zone surrounding each plant. Appropriate setbacks and access paths within the plant have been included. (Source: Guidelines for Developers Volume IV : Published by Sewerage Services Department, Ministry of Housing and Local Government)

APPENDIX D

Methods for Population Forecast

D1 Population Forecast

General Considerations

Catchment populations will have to be estimated taking due consideration of all those factors governing the future growth and development of the Catchment area; especially with respect to industrial, commercial, educational, social and institutional planning and growth. Special factors causing sudden immigration or influx of population should also be foreseen to the extent possible.

A judgment based on these factors would assist in selecting the most suitable method of estimating the probable trend of population growth in a Catchment. In this context the following mathematical methods, graphically interpreted where necessary, may be employed.

D2 Demographic Method of Population Projection

Population change can occur only in three ways i.e. (i) by births (population gain) (ii) by deaths (population loss) or (iii) migration (population loss or gain depending on whether movement out or movement in occurs). Annexation of an area may be considered as a special form of migration. Population forecasts are frequently obtained by preparing and summing up of separate but related projections of natural increases and of net migration.

The net effect of births and deaths on population is termed natural increase (natural decreases, if deaths exceed births).

Migration also affects the number of births and deaths in an area, and so projections of net migration are prepared before projections for natural increase are carried out.

This method thus takes into account the prevailing and anticipated birth rates and death rates of the region or catchment for the period under consideration. An estimate is also made of the immigration from, and emigration to, the community and its growth area. The net increase of population is calculated accordingly considering all these factors by arithmetical balancing.

D3 Arithmetical Increase Method

This method is generally applicable to large and well developed Catchments. In this method the average increase of population per decade is calculated from the past records and added to the present population to estimate the population in the next decade. This method gives a relatively low estimate and is suitable for well settled and established communities.

D4 Incremental Increase Method

In this method the increment in the arithmetical increase is determined from the past decades, and the average of noted increments are added to the average increase. This method tends to over estimate population predictions compared with those calculated from the arithmetical increase method.

D5 Geometrical Increase Method

In this method percentage increases are assumed to be the rate of growth, and the average of past percentage increase rates are used to determine future increments in population. This method gives a much higher relative predictive value, and is mostly applicable for growing towns and cities (and catchment areas) having vast scope for expansion.

D6 Decreasing Rate of Growth

In this method it is assumed that rate of percentage increase decreases overtime. The average decrease in the rate of growth is calculated. The percentage increase is then modified by deducting the decrease in rate of growth. This method is applicable only in such cases where the rate of growth of population shows a downward trend.

D7 Graphical Method

In this approach there are two methods. In one, only the Catchment under review is considered, and in the second, other similar Catchments are also taken into account.

1. Graphical Method Based on Single Catchment

In this method the population curve of the Catchment (i.e. the population in past decades) is smoothly extended to obtain future population values. This extension has to be done carefully and it requires vast experience and good judgment. The line of best fit may be obtained by the method of least squares.

2. Graphical Method Based on Catchments with Similar Growth Patterns

In this method the Catchment in question is compared with other Catchments which have experienced similar forms of development which the subject Catchment is likely to undergo. Based on this comparison, a graph exhibiting population against time is plotted and extrapolated.

D8 Logistic Method

The S shaped logistic curve for any Catchment gives complete trend of growth of the Catchment right from beginning to saturation limit. This method is applicable for very large Catchments with sufficient demographic data.

D9 Method of Density

In this approach the trend in the rate of population density increases for each Catchment of a Town is determined, and the population forecast is carried out for each Sub-Catchment based on the above approach. The addition of Sub-Catchment populations gives the population of the Composite Subject Catchment.

D10 Final Forecast

While forecasts of potential population levels of a Catchment at any given time during the Planning Period can be derived by any one of the foregoing methods appropriate to each case, the density and distribution of deduced population levels within sub-areas located within the Catchment will have to be made based on the relative probabilities of expansion within each sub-area, according to its nature of development and based on existing and contemplated town planning regulations, or structure plans.

Wherever population growth forecast or master or structure plans prepared by town planning or other appropriate authorities are available, the decision regarding the design population should take their figures into account.

APPENDIX E

Basic Approaches for making Alternative

E1 Introduction

It is recommended that the Study Area under consideration be divided into catchments and sub-catchments based on topography, drainage pattern, existing development patterns and physical constraints and sewerage alternatives be formulated for each catchment based on the categorization of catchments.

In order to formulate detailed sewerage strategies based on the nature of each catchment / sub-catchment, several essential factors need to be taken into consideration as outlined below:

1. The existing and future land use patterns of each catchment / sub-catchment highlighting the existing major urban/suburban centres and major growth centres for residential, industrial and institutional types of development.
2. The natural drainage of the study area into the existing main rivers.
3. Distance from water intake points.
4. The topography of the study area to identify the undulating terrain with hilly land formations, which necessitate the provision of network pump stations for transfer of flows for discharge to permanent STP located in adjoining drainage catchment / sub-catchment.
5. Major new developments, which have been approved by the local authorities and are in the early stages of implementation or in the planning stages to be implemented in the near future that provide good potential for an integrated strategy of having common permanent STPs.
6. The potential for future growth within the planning period, especially in term of growth in predominantly residential developments.
7. The urgent need to connect areas served by individual septic tanks (IST) and the Imhoff tanks (IT).
8. The need to reduce the number of existing small-scale temporary STPs, by rationalising through upgrading existing STPs or construction of a new permanent STPs.

CATEGORIZATION OF SUB-CATCHMENTS

The sub-catchments are categorized into 3 types (Type 1, Type 2 and Type 3) based on the following criteria:

- i) Existing and projected population density (high or low)
- ii) Distribution and type of existing developments (concentrated, moderately spread out, or sparsely distributed)
- iii) Committed and proposed developments (significant in the immediate term, short term, or long term)

- iv) Social and/or environmental benefits of sewerage the sub-catchment (whether high or low, in the immediate term or long term)

The Type 1 sub-catchments are defined as follows:

- i) High existing population density, high existing and projected PE.
- ii) Significant well developed and urbanised areas with existing sewage treatment plants (STP) and/or individual septic tank (IST) areas, which can be conveniently rationalised in future to permanent STPs.
- iii) Major ongoing developments, which strategically can be sewerage to permanent Centralised Sewage Treatment Plants (CSTP) either within the development or to adjoining sites; and proposals for major developments submitted to Indah Water Konsortium.
- iv) Significant social, environmental and operational benefits to sewer these areas in the immediate term (0 to 5 years)

Type 2 sub-catchments are defined as:-

- i) Medium population and development density in the sub-catchment
- ii) Existing development are spread out
- iii) No major development (>50,000 PE) proposed in the next 5 years.
- iv) Low benefits (socially or environmentally) in the short term (next 5 to 10 years) to sewer these areas and costs could be high (small PE and sewer lengths will be long)

Type 3 sub-catchments are defined as: -

- i) Rural and very low density sub-catchments
- ii) Limited, sparsely distributed and small existing developments
- iii) No major developments (>10,000PE) proposed in the next 10 years
- iv) Low benefits (socially or environmentally) in the long term (over 10 years) to sewer these areas and costs would be prohibitive.

There are three basic sewerage alternatives, on-site system, multi-point system, and centralized system in sewerage management strategies. For operation and maintenance, centralized system and multi-point system are favored because of the reduction of number of STPs and discharging points. On the capital investment, however, these systems are not favorable due to high construction cost. Therefore, it is necessary to evaluate these three systems in actual planning.

Generally, on-site systems are suggested for Type 3 catchments (that is rural and very low density sub-catchments), while multi-point systems are suggested for type 2 sub-catchments. Centralised system is suggested for Type 1 sub-catchments.

Inter-transfer of sewage between catchments should also be considered either by pumping or use of deep sewers to cross topographical and drainage boundaries especially if a regional STP solution is to be considered. A key consideration in formulating alternatives is availability of suitable sites for location of central sewage treatment plants and regional sewage treatment plants. More often than not the location of the available STP site drives the formulation of alternatives. Multipoint STPs are usually sited within existing STP reserves, for example existing oxidation pond or aerated lagoon sites which can be conveniently upgraded to fully mechanized STPs.

In this Appendix, an example of how to analyse the sewerage strategy is presented depending on the specific situation of a study area. Although, the examples illustrate a qualitative analysis, in actual evaluation, quantitative analysis would be conducted.

E2 Example of Analysis Approaches

There are three basic alternatives, on-site system, multi-point system, and centralized system in sewerage management strategies. For operation and maintenance, centralized system and multi-point system are favored because of the reduction of number of STPs and discharging points. On the capital investment, however, these systems are not favorable due to high construction cost. Therefore, it is necessary to evaluate these three systems in actual planning.

In this Appendix, an example of how to analyse the sewerage strategy is presented depending on the specific situation of a study area. Although, the examples illustrate a qualitative analysis, in actual evaluation, quantitative analysis would be conducted.

Figure E.1 shows the five zone situations as examples of analysis approaches for alternatives. The characteristics on each zone are described by the three factors which are, pollution production load, reduction of pollution load, and pollution load reduction cost.

Pollution production load is defined as the production of pollution load in a certain zone per the area of a certain zone which means the intensity of sewerage production in a certain zone. This load expresses the necessity of sewerage system.

Reduction of pollution load is defined as the reduced pollution load by the introduced sewage treatment in a certain zone. This reduction expresses the effect of the new sewerage system. A high value means there is a significant effect of the introduced sewerage system on the reduction of sewage pollution load.

Pollution reduction cost is defined as the total costs during the planning years including capital and O&M costs divided by the reduced pollution load resulting from the provided sewage treatment. This value expresses the unit cost of the introduced sewerage system in terms of reduced pollution load. A low value means that the reduction of sewerage pollution load is achieved with a low cost.

The outline of each zone follows.

Zone A is a new development site which does not have a sewerage system at present. After development, high pollution production load is expected because of an increase in population. Also high reduction of pollution load is expected when the sewerage system is constructed because there is no treatment of sewage at the present. Therefore Zone A has high demand for installing sewerage system. However, Zone A is located further upstream from the proposed central STP. It has a high pollution reduction cost because there is a high cost to connect Zone A to the proposed STP and reticulate sewers in Zone A.

Zone B is already developed and has a regional STP at present. There is now a high pollution production load in light of the completed developments. Due to the existing regional sewerage system, the reduction of pollution load is expected not to be high when zone B is connected to the proposed regional STP further downstream. However, the pollution reduction cost may be medium or low because the zone B is already connected to a regional STP and only a trunk sewer is needed to connect to the downstream STP. Moreover, the construction cost to connect is not high due to the short distance to the regional STP.

Zone C is an undeveloped site which does not have a sewerage system at present, and also, no future development plan. Therefore, since it is expected that population in the future will be low, this zone has a low pollution production load and likewise, a low reduction load. Consequently, a high pollution reduction cost is expected due to high construction costs and low reduction of pollution load.

Zone D is a new development site. The situation of Zone D is as the almost same as that of Zone A except that the trunk sewer length to the downstream STP will be much shorter. Therefore, Zone A has a high demand for installing a sewerage system and a low pollution reduction cost due to low construction cost to connect to the proposed regional STP.

Zone E is an undeveloped site with no future development plan. Zone E has a low pollution production load and a low reduction of load. The reduction cost is low because this zone is the closest to the regional STP compared to other zones.

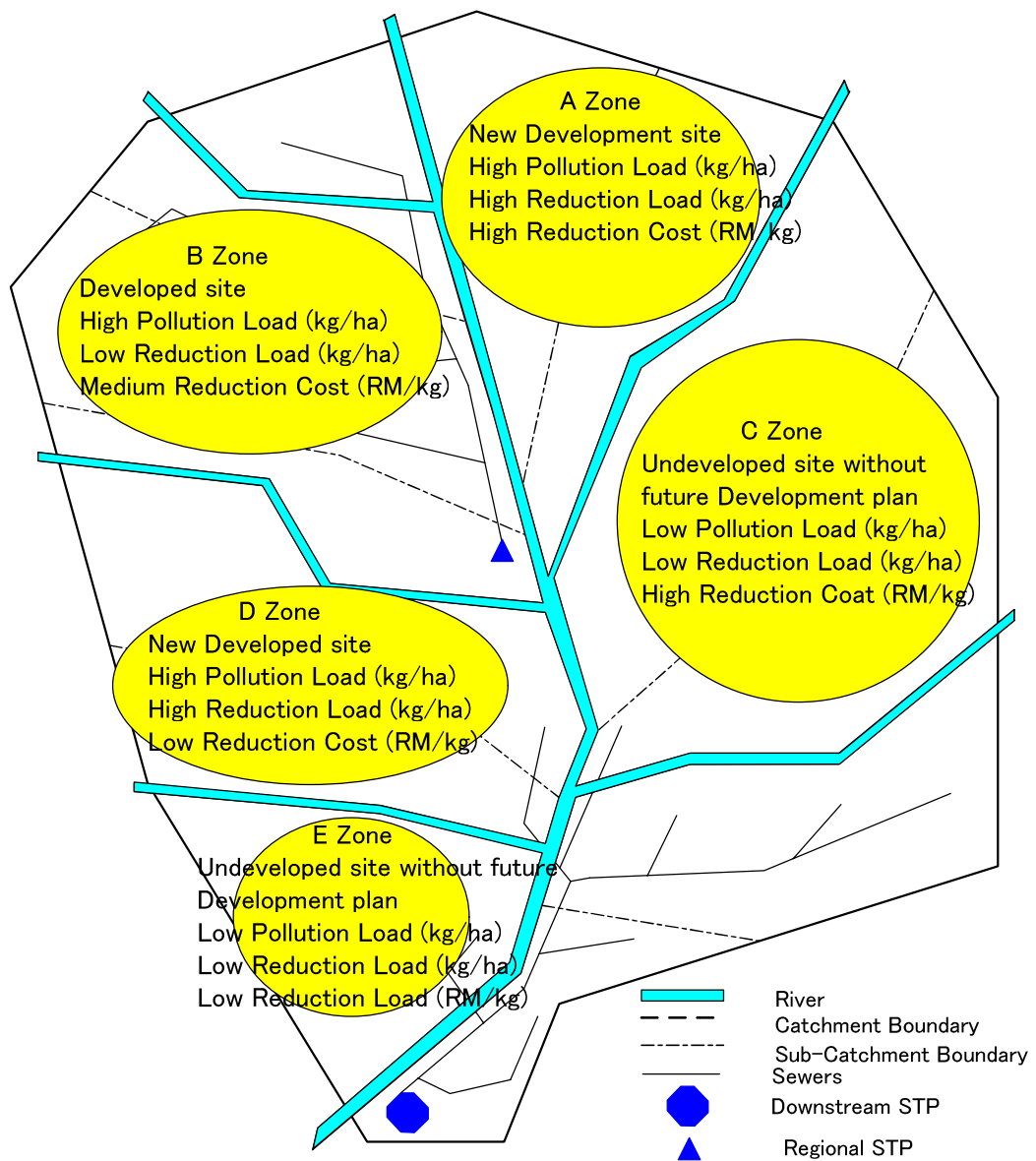

Figure E.1 Situations on Each Zone

An outline summary is shown in Table E.1. Based on the zone characteristics, the following alternatives are expected.

Zone A is recommended to have regional STP. There is high necessity for introducing a sewerage system but reduction cost is high. Therefore, a regional STP is preferred for this zone instead of connection to the central STP which will increase costs.

For Zone B, connection to a regional STP or another STP is recommended. Since the reduction of pollution load is low because the Zone B already has a regionalised STP, the reduction cost has become a key factor. If the reduction cost

is low, connection to another STP is favoured. When it is medium, a regional STP might be favoured.

Table E.1 Summary of Each Zone

Zone	Pollution Production Load Kg as BOD/ha	Reduction of Pollution Load Kg as BOD/ha	Reduction Cost* RM/kg as BOD	Alternative
A	High	High	High	Regionalised
B	High	Low	Medium - Low	Regionalised Or Connection to another STP
C	Low	Low	High	On-site
D	High	High	Low	Connection to another STP
E	Low	Low	Low	Connection to another STP

*based on connection to a centralised STP

Zone C is clearly an on-site zone. The reasons are that it has a low production load, low reduction, and high reduction cost. Therefore, an on-site treatment is preferred for Zone C.

For Zone D, connection to another STP is recommended. The reasons are that there is high necessity for introducing a sewerage system and the reduction cost is low. Therefore, a connection to another STP is preferred.

Zone E is recommended to connect to another STP. The reason is the low reduction cost. Although the pollution load and reduction load are low, the low reduction cost will allow for the treatment of the sewage in Zone E to another STP.

E3 Conclusion

This Appendix shows an example for analysing alternatives. The evaluation factors may change in actual cases. In some cases, impact on safety or noise nuisance may be considered as qualitative factors and are added to the reduction cost or pollution production load. Therefore, the selection of the evaluation factors

should take into account the actual site conditions and its priority on the catchment strategies

APPENDIX F

Glossary of Abbreviations

Appendix F Glossary of Abbreviations

ADWF	Average Dry Weather Flow
AIC	Average Incremental Cost
AL	Aerated Lagoon
AWWF	Average Wet Weather Flow
BF	Bio-Filter
BOD	Biochemical Oxygen Demand
BOD₅	Five Day Biochemical Oxygen Demand
BS	Bio-Soil
°C	Degrees Centigrade
CaCO₃	Calcium Carbonate
CCTV	Close Circuit Television
COD	Chemical Oxygen Demand
CST	Communal Septic Tank
Cu.m	Cubic Metres
DBKL	Dewan Bandaraya Kuala Lumpur
dia.	Diameter
DGSS	Director General of Sewerage Services
DOE	Department of Environment, Malaysia
E	Existing
EA	Extended Aeration
e.g.	Example
Elec.	Electrical
ELEV.	Elevation
EPU	Economic Planning Unit
FBAS	Fine Bubble Activated Bio-solid
g	Grammes
GR	Ground
ha	Hectares
HDPE	High Density Poly Ethylene
HK	High-Kleen
HRMB	High Rate Mechanised Biological Treatment System
INV	Invert
IWK	Indah Water Konsortium Sdn Bhd
IT	Imhoff Tank
IST	Individual Septic Tank
JAS	Jabatan Alam Sekitar
JBA	Jabatan Bekalan Air
JKR	Jabatan Kerja Raya
JPN	Jabatan Perumahan
JPP	Jabatan Perkhidmatan Pembetungan
JPS	Jabatan Pengairan dan Saliran
km	Kilometre
LA	Local Authority
m	Metre
m²	Square Metres
m³	Cubic Metres
Mech.	Mechanical

mg/l	Milligrammes per litre
MH	Manhole
mm	Millimetres
MPPJ	Majlis Perbandaran Petaling Jaya
No.	Number
NPV	Net Present Value
%	Percentage
OD	Oxidation Ditch
O&M	Operations and Maintenance
OP	Oxidation Pond
P	Phosphorous
PA	Planning Approval
PE	Population Equivalent
PF	Peak Flow Factor
PWWF	Peak Wet Weather Flow
RBC	Rotating Biological Contactor
RM	Ringgit Malaysia
SATS	Sewage Aeration Treatment System
SCP	Sewerage Catchment Plan
SHD	Shop House Development
SS	Suspended Solids
SSD	Sewerage Services Department
STF	Bio-solid Treatment Facility
STM	Syarikat Telekom Malaysia
STP	Sewage Treatment Plant
TOC	Total Organic Carbon
TSS	Total Suspended Solids
UC	Under Construction
US	United States of America
wc	Water Closet