

Scientific Support for the Design and Operation of Ventilated Improved Pit Latrines (VIPs) and the Efficacy of Pit Latrine Additives

CA Buckley, KM Foxon,
CJ Brouckaert, N Rodda,
C Nwaneri, E Balboni,
A Couderc & D Magagna

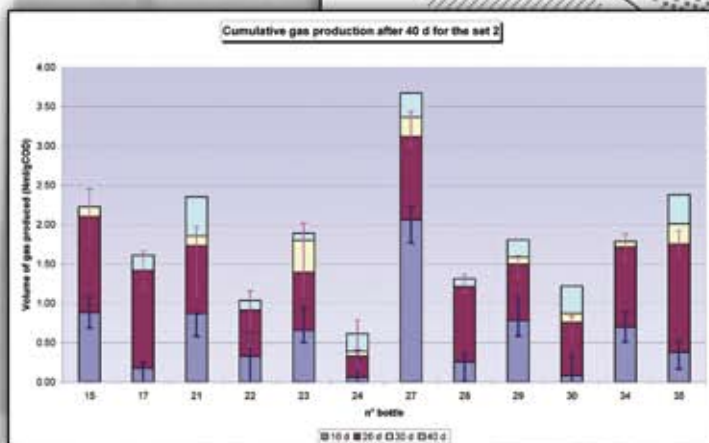

TT 357/08

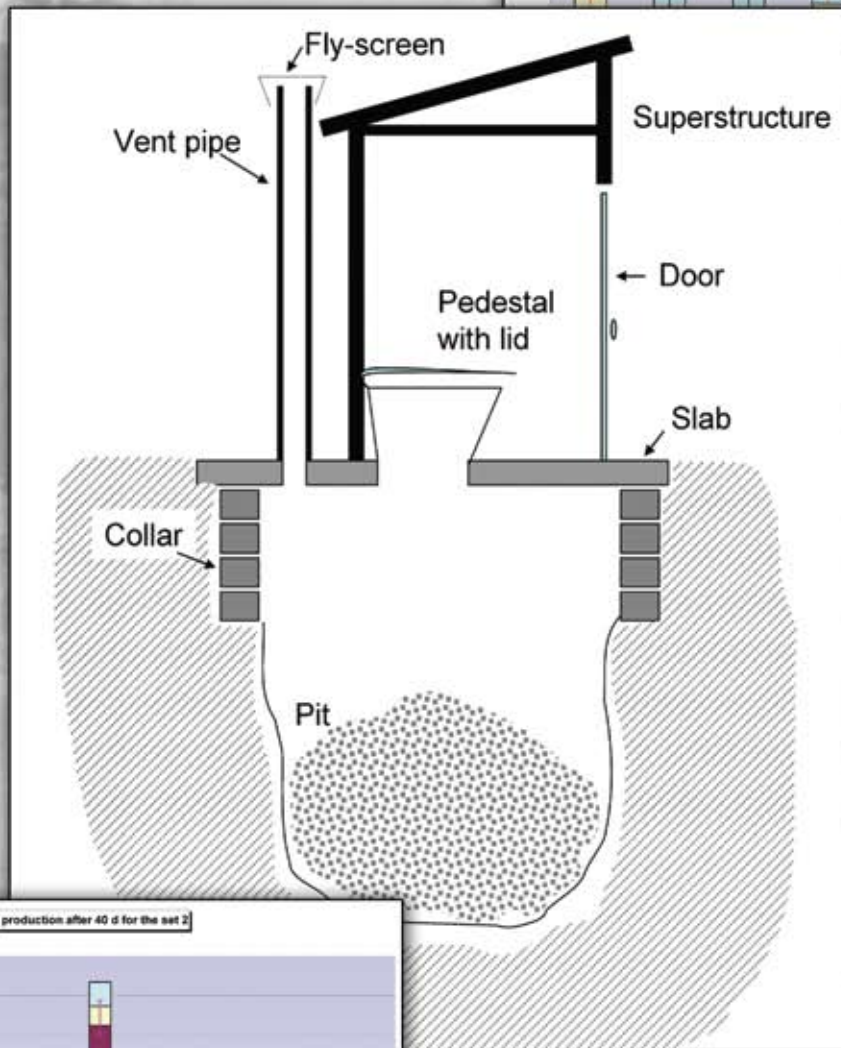
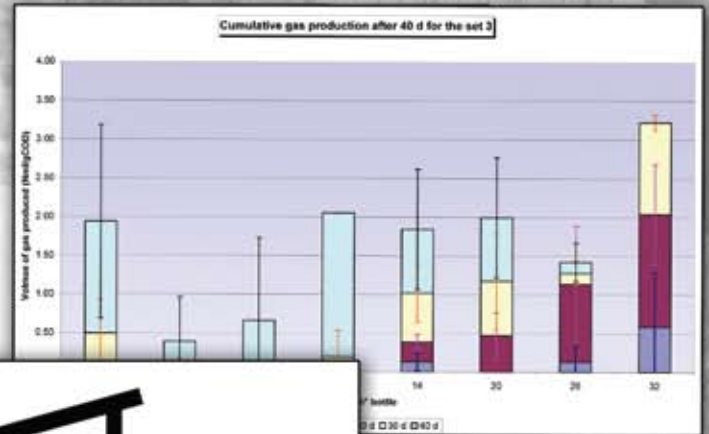

Water
Research
Commission

**SCIENTIFIC SUPPORT FOR THE DESIGN AND OPERATION OF
VENTILATED IMPROVED PIT LATRINES (VIPS) AND THE EFFICACY OF
PIT LATRINE ADDITIVES**

Report to the
WATER RESEARCH COMMISSION

by

**CA Buckley, KM Foxon, CJ Brouckaert, N Rodda, C Nwaneri,
E Balboni, A Couderc & D Magagna**

on behalf of

**Pollution Research Group
School of Chemical Engineering
University of KwaZulu-Natal**

**WRC REPORT NO TT 357/08
JUNE 2008**

Obtainable from

Water Research Commission
Private Bag X03
Gezina, 0031

orders@wrc.org.za

The publication of this report emanates from a project entitled *Scientific Support for the Design and operation of Ventilated Pit Latrines (VIPS)* (WRC project no K5/1630).

DISCLAIMER

This report has been reviewed by the Water Research Commission (WRC) and approved for publication. Approval does not signify that the contents necessarily reflect the views and policies of the WRC, nor does mention of trade names or commercial products constitute endorsement or recommendation for use.

ISBN 978-1-77005-718-0

Printed in the Republic of South Africa

EXECUTIVE SUMMARY

1 Introduction

Ventilated improved pit latrines (VIP) are an accepted basic sanitation delivery option and are the regulated minimum acceptable level of sanitation in South Africa.

For a pit latrine to qualify as a VIP, it must comply with certain requirements; it must (i) provide hygienic separation of human waste from contact with people, (ii) have a vent pipe fitted with a fly-screen to minimise odour and flies; (iii) be built on a secure slab that will resist collapse of the superstructure, and (iv) provide privacy and dignity for the user.

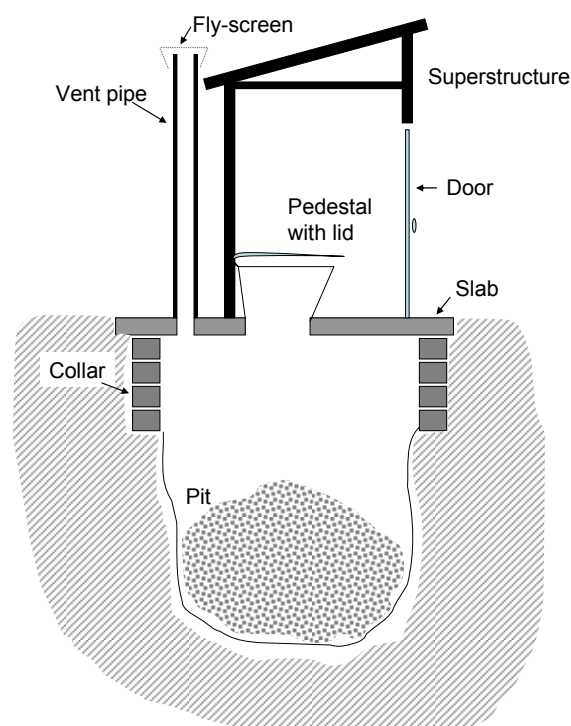

Figure 1: Basic structure of a VIP

The basic processes occurring in a VIP are filling (with faecal, water and other material), water transfer into and out of the pit, biological transformation and pathogen deactivation. In general, the rate of filling of the pits as a function of local conditions is not well known; neither is there a good understanding (at least at a policy-making level) of what the condition of the material in the pits will be when the pits become full.

In principle the rate of degradation or leaching of the material in a pit should be similar to the rate of filling thus providing a long service life for the pit. In practice, it is often observed that pits may fill rapidly, particularly if a significant portion of the material added to the pit is non-degradable. Management of full pits pose a number of complex challenges to policy-makers, local authorities and householders since households or communities with full pits are no better off than those with no sanitation at all.

One of the solutions proposed for management/disposal of pit latrine sludges is a range of commercial products hereafter referred to as pit latrine additives. These may be chemical, microbiological or enzymatic in nature and are marketed on their ability to reduce (or even reverse) the accumulation rate in pit latrines, and reduce potential fly or smell problems. Independent scientific investigations into their efficacy are limited and

ambiguous, although there is anecdotal evidence that suggests that they have the ability to significantly reduce the mass or volume of pit contents, fly and odour problems. Equally, a number of informal studies have suggested that there is no significant benefit to the use of these additives over the addition of water or some essentially inert additive (in effect, a placebo). In many instances, municipalities and other service providers are hesitant to sanction the use of pit latrine additives as they have no scientific basis for choosing one product over another, and are concerned that trials with these products may lead to an expectation among communities that the products will be used forthwith. This in turn could lead to a situation where political pressure results in the application of expensive products that may or may not have any significant benefit. It is generally felt that a scientific explanation of the mechanism of pit latrine additives, and proof of their efficacy would provide the authorities with the ability to rationally assess the cost-effectiveness of implementing programmes for treating pits with commercial pit latrine additive products.

This project proposed to undertake field and laboratory investigations of VIPs and their contents in and around the eThekweni Municipal area in order to understand the conditions found in the pits and to propose design and operating practice that will extend the life of pits. The study proposed to concentrate on three main areas of interest:

- Water balance in pits under different hydro-geological conditions (water draining into the pit, water draining out of the pit, no water transfer in or out of the pit)
- Stabilisation rates in pits (organic, pathogens)
- Efficacy and action of additives on pit processes

2 Literature Review

A comprehensive review of literature relating to the design and operation of pit latrines, processes in pit latrines and pit latrine additives was undertaken. There is not much formal scientific literature in terms of journal publications or conference proceedings that provide much insight into the processes in pit latrines. However there is a wide range of literature relating to design, operation and maintenance issues that shed some light on the nature of pit latrine contents and the processes that may occur there.

It was concluded that the dominant mechanism of stabilisation in the unaerated bulk of the pit latrine contents would be anaerobic digestion, while some aerobic degradation would occur at the top layers. In most pits which are not sealed, movement of moisture in and out of the pits depends on the type of soil/rock in which the pit is located, the presence and height of groundwater and the amount of moisture added to the pit. Soluble and to a lesser extent colloidal material move in and out of the pit with the moisture flow. The movement of soluble organic material out of the pit with moisture flow may be a significant mechanism of removal of organic content from the pit.

The literature review also highlighted the fact that there is usually a lot of non-degradable material in pits, and that the amount and type of material in the pit depended on user habits and was linked to the solid refuse removal services available to the pit users.

3 Processes in pit latrines

A number of studies were undertaken within this project to characterise the material found in a pit latrine and to infer what processes have occurred in the pit latrine from the time when material is added via the pedestal to the time when it is sampled from some depth within the pit. Chapter 3 presented the findings of studies into processes occurring in pit latrines. These include:

- A study characterising fresh faecal material

- A number of studies in which pit latrine contents from a number of pits were characterised
- Two studies from which the differences in pit latrine contents at different points within the same pit were investigated
- Two studies in which the effect of additional moisture content and alkalinity (in the form of added sodium bicarbonate) were investigated.

3.1 Variability of pit latrine contents

It was observed that the nature of pit latrine contents varied widely within a pit latrine and between pit latrines. It was found that pit latrine contents could look very different and have very different chemical and physical characteristics when comparing pits from different communities and even within communities. Many of the variations noted were due to differences in user practices, such as the type of anal cleansing material used, and the practice of using the pit as a solid waste disposal site in some communities. Other variations may have been due to the geographical location of the pit latrine such as moisture content due to presence of groundwater. Differences were observed between samples taken from the top of the pit, and samples buried within the pit. Differences in nature of pit contents affect the type and extent of biological processes that may occur. Equally, the processes occurring affect the nature of the pit contents, particularly of the pit contents located well below the surface of the pit latrine. These observations are important because they emphasise the fact that management of pit latrine sludge is not a one-dimensional problem, but may require different approaches that are dependent on the nature of the pit contents.

3.2 A general theory describing processes in a pit latrine

A general theory was presented to describe the fate of organic material that enters a pit latrine. On the basis of measurements of characteristics of pit latrine contents, and observations from the many samples handled during the project it was hypothesised that (i) all readily biodegradable originating from faeces is aerobically degraded by naturally occurring micro-organisms within a very short time of arriving on the surface of the pit; (ii) a significant portion of the remaining biodegradable material is aerobically degraded before being covered over by new pit contents; (iii) the remaining biodegradable material, including organic residual from dead cells from micro-organisms and from the original faeces are slowly converted to soluble products, methane gas and carbon dioxide in the buried layers of the pit contents (the fraction of the original organic material that is converted by this path is not large); and finally (iv) the material that remains at the bottom of the pit latrine or after a long residence time in the pit is largely non-degradable.

These stages are presented graphically in Figure 2.

The following additional conclusions were drawn from studies on processes in pit latrines:

- It was found that the rate of anaerobic digestion of pit latrine contents taken from the surface of the pit could be accelerated by the addition of moisture. Specifically, the rate of gas production increased by a rate of between 0.006 and 0.02 ml gas/g total solids/day per 1% increase in moisture content above the baseline moisture level of 76%.
- The effect of increasing the alkalinity so as to increase pH buffering capacity on anaerobic digestion of faeces and samples taken from the top layer of a pit latrine was tested by addition of different amounts of sodium bicarbonate. It was found that none of the treatments with sodium bicarbonate resulted in statistically significant increases in the rate of gas production under anaerobic conditions. It was concluded that alkalinity was not a limiting factor in anaerobic digestion of pit latrine contents.
- Buried material taken from well below the surface of the pit latrine had very poor gas production potential under anaerobic conditions. Low rates of gas production were attributed to low inherent biodegradability of this material, since it was assumed that much of the biodegradable material in the

original faecal material had been converted during residence on the surface of the pit contents. Thus no significant effect on gas production rate was observed by increasing moisture content or alkalinity of samples of this nature.

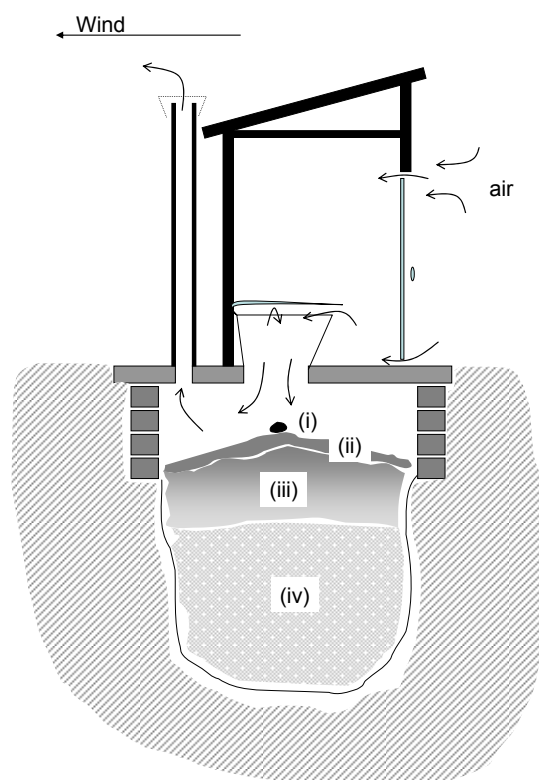

Figure 2: Diagram of a pit latrine showing the different theoretical layers (i) fresh stool; (ii) partially degraded aerobic surface layer; (iii) Partially degraded anaerobic layer beneath surface; (iv) completely stabilised anaerobic layer.

3.3 Health risks associated with pit latrine contents

Examination of face masks worn by workers engaged in emptying pit latrines and screening the exhumed contents indicated that viable ova of a number of helminth species including *Ascaris*, *Trichuris* and *Taenia* spp (roundworm, whipworm and tape worm) may be present in pit latrine contents and that these constitute a significant health risk to workers involved in handling pit latrine contents, and community members who have access to the area around the pit latrine during and after pit emptying operations.

This study has not elucidated the mechanism or rate of pathogen deactivation in pit latrine contents under aerobic or anaerobic conditions. However, isolation of a large number of helminth ova on workers' masks indicates that contact with the pit latrine contents carries a significant risk of infection by helminths, and potentially by other human pathogens.

4 Investigation into commercial pit latrine additives

Only two reports of scientific research into pit latrine additives were found in the literature. Both inferred that pit latrine additives showed promise for reducing pit latrine contents. However, in the first study, quantitative results were based mostly on laboratory experiments that used many times the amount of additive that would exist in a pit latrine, and ensured complete aeration and contact between sample and additive. Under these conditions, the additives were shown to have a significant effect in bioconverting faecal material. Field trials

in this study were undertaken on pit latrines that were not in use during the study. The results were not conclusive, but indicated that reduction in height of pit contents might be achieved through the addition of pit latrine additives. In the second study pit latrine additives were injected into pit latrines using a pump. Again, it appeared that the pit latrine additives had an effect on the chemical composition and load of the material in the pits. However, there were no control experiments against which the results could be compared, and it is not clear how much of the changes observed were due to the physical treatment (aeration and mixing) and how much to the presence of micro-organisms from the additives.

The biggest difficulty associated with testing of commercial pit latrine additives is to create a controlled environment which is sufficiently reproducible, but not too different to the conditions expected in a real pit latrine.

Chapter 4 presents the findings of a small scale field trial and a more detailed laboratory study to test the efficacy and action of commercial pit latrine additives.

4.1 Field trial to test the efficacy of pit latrine additives

A small-scale field trial was undertaken during the course of the project using a single brand of pit latrine additive (in two different preparations) and two placebos that had a similar appearance to the pit latrine additives. The performance of the pit latrine additives was assessed by measuring the change in the height of the top of the heap of pit contents with time.

Both increases and decreases were observed in the height of pit latrine contents, and there was absolutely no pattern that could be observed linking the measured height of the pit contents to the treatment applied.

The purpose of this trial was partially to test the methodology of field trials. An important outcome of the study was the conclusion that such tests are critically dependent on having the ability to accurately determine the changes in pit contents volume with time. Simple height measurements do not provide this accuracy since the shape of the pit can change substantially between measurements; in this case the change of height is not directly related to the change in pit contents. It was proposed that a number of photographs of the shape of the pile could be used to determine the shape and depth of the pit surface using image recognition software. The device for recording these images and the associated software is in the process of being developed and has been dubbed the *faecometer*.

4.2 Development of a protocol for testing pit latrine additives

The findings of the field study confirmed that field trials for testing pit latrine additives have limited application in providing scientifically defensible data for assessing efficacy of pit latrine additive products due to the lack of control of external factors, and difficulties associated with ensuring suitable control experiments with which to compare experimental results. While wide-scale field testing may be employed to obtain statistically significant results, it was generally concluded that a controlled, laboratory-scale trial according to a well-defined protocol would provide more reliable data for understanding efficacy of these products.

A protocol was developed for testing the efficacy and mechanism of commercial pit latrine additives in the laboratory. The conditions created by the implementation of these protocols were sufficiently controlled to be reproducible while giving some indication of the potential for these products to work in the field. It was necessary for this protocol to be repeated for as many additives as possible and on more than one pit latrine sludge to provide a defensible basis on which to build a pit latrine additive policy.

The protocol incubated samples of pit latrine contents and pit latrine additives dosed according to manufacturer's instructions on a per area basis (i.e. the dosage for a pit latrine was reduced by a factor determined by the relative surface area of the laboratory unit and the surface area of pit contents in an average pit latrine). The test was performed in honey jars with a capacity of approximately 300 g pit latrine

sludge and therefore could be undertaken with a large number of replicates. Samples were kept in a fume cupboard under high humidity conditions to minimise mass change by drying. Half of the experimental units were open to simulate pit conditions with oxygen ingress, while the other half were closed to observe the effect of the additives in lower layers when the oxygen supply is cut off. Mass loss results were compared to those from units containing untreated pit latrine contents, and pit latrine contents with water or alkaline solution. Chemical analyses of the pit latrine material before and after the test were performed and the results used to ascertain whether any significant changes in sample characteristics could be observed between different treatments.

In the course of this project a selection of pit latrine additive suppliers were contacted and asked to provide information relating to the composition and efficacy of their products. Samples of these products were tested using the protocol described.

4.3 Laboratory-scale testing of pit latrine additive products

Commercial pit latrine additives were found to contain large concentrations of active micro-organisms with the ability to utilise organic substrates. However, neither the field trials, nor the laboratory trials provided evidence that the use of these products could result in a significant reduction in either mass or volume of pit latrine contents. There were two probable causes of this result:

- In the study into processes in pit latrines, it was concluded that much of the biodegradable material in faecal sludge is degraded very shortly after material is added to the pit latrine, mediated by the presence of naturally occurring micro-organisms present in the pit latrine and the added faeces. Thus the residual biodegradability of pit latrine contents is low compared to added faeces, and significant decreases in the volume or mass of the bulk of the buried contents through biological degradation are not possible;
- The high concentration of naturally occurring degradative micro-organisms in the faeces and pit latrine contents was of a similar order of magnitude to the concentration in the added pit latrine additives. However the overall number of micro-organisms in the active surface layer of the pit latrine (calculated by the concentration of micro-organisms multiplied by the mass or volume of the active surface layer) was far greater than the total number of micro-organisms added with the treatment of commercial pit latrine additive. Thus, although the added micro-organisms may have been successful in degrading organic material, the increase in the rate of degradation due to treatment with pit latrine additives was negligible since high degradation rates were observed in untreated samples.

An important observation was made in understanding the results of these experiments: Although pit latrine content samples should be well mixed before being used in pit latrine additive trials, a random distribution in biodegradation and mass loss rates in sub-samples must be expected due to the slightly different nature of the material in each sub-sample. Thus the conclusion that a treatment has a significant effect on degradation or mass loss rates observed in control or reference treatments must be made on the basis of a systematic change observed in a number of replicates of the same treatment.

Thus when a particular unit exhibits a higher rate of mass loss than other units (as is seen in the first replicate of treatment K, Figure 3), this cannot be interpreted as having been caused by the treatment unless the other two replicates show an increased rate of mass loss when compared to the control units.

Under aerobic conditions (no limitation of oxygen supply), there was no significant increase in the rate of degradation of pit latrine contents due to the addition of commercial pit latrine additives at the recommended dosage rates (g additive/ m² pit latrine contents). Similarly under limited oxygen supply conditions (anaerobic conditions) the rate of degradation was not enhanced by addition of commercial pit latrine additives at the recommended dosage rates, and in fact, the overall rates of degradation in terms of observed mass loss

from samples were considerable lower than under aerobic conditions. Figure 3 shows the rate of mass loss observed in all treatments and controls for trial 2 of the additive testing protocol.

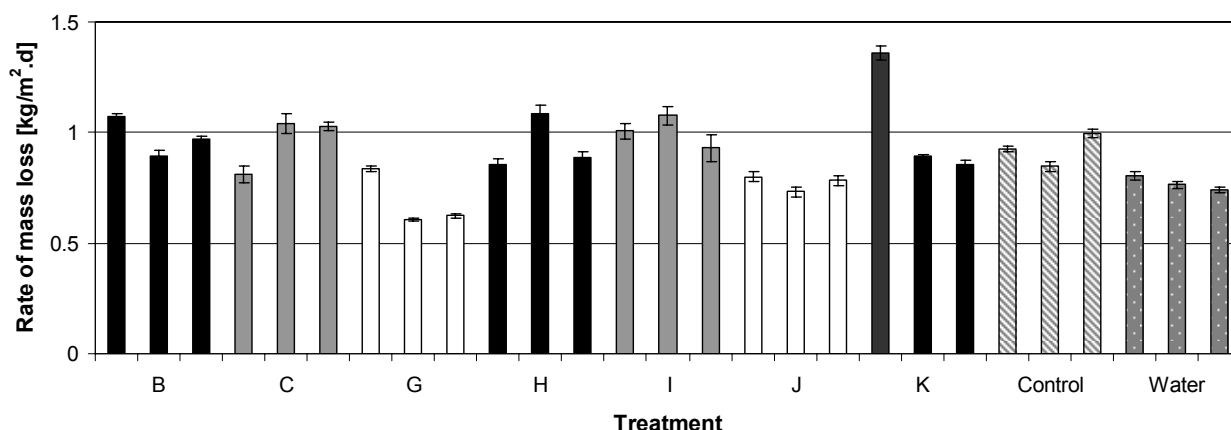

Figure 3: Aerobic incubation of pit latrine contents with commercial pit latrine additives. Average rate of mass loss after 46 days of incubation at 25°C. Seven pit latrine additives were tested in 3 replicates. Control indicate samples incubated without additional water or chemical/biological additive. Water indicates samples to which tap water only was added. Error bars indicate 95% confidence interval on the rate of mass loss.

4.4 Conclusions of the studies into the efficacy of pit latrine additives

A number of conclusions are drawn relating to the design of experiments for testing the efficacy and action of pit latrine additives:

- Pit latrine additive studies must be carefully designed to separate the effect of natural (unenhanced) biological activity, the method of treatment (i.e. adding water/mixing) and the effect of the additives themselves on pit processes through the implementation of appropriate control and reference experiments.
- There is a political and societal argument for field trials of pit latrine additives; however, these must be carefully designed to separate the effects of the additives and other factors through the implementation of appropriate control and reference experiments; furthermore, reliable methods of assessing volume change must be developed to measure the effect of the treatments on pit latrines since simple height measurements have been found to be subjective and do not provide an accurate measure of the volume changes in the pit.

Given the large uncertainty and variation that will be observed in field trials, there is a need for a standardised protocol for testing the performance of the additives under controlled conditions. It is simply not possible to replicate field conditions in a controlled manner. It is therefore a *strong recommendation* of the project team that conclusions about the efficacy of commercial pit latrine additives be based on controlled laboratory based experiments, rather than on field trials.

Finally, it was concluded that this study has shown no benefit in the use of pit latrine additives to accelerate the rate of degradation of pit latrine contents under either aerobic or anaerobic conditions. Furthermore, it was concluded that the financial cost of use of these additives was likely to be less than the cost of manually emptying the latrine every 5 years provided an appropriate pit emptying programme was in place.

5 Discussion and Conclusions

The findings of this project are discussed in Chapter 5 and presented as conclusions in Chapter 6.

5.1 VIP design, operation and maintenance

The standard VIP design was found to be effective for the accumulation and degradation of faecal sludge. However, it was observed that the ability of a VIP latrine to function as an improved sanitation system i.e. to provide hygienic separation of human waste from human contact, to limit the transport of pathogens from human waste by vectors such as rodents and insects, to reduce nuisance associated with flies and odour and to preserve the dignity of the user, was compromised in a number of respects due to *poor construction*, *bad user habits*, and *during pit emptying operations*. These were discussed in detail in Chapter 5 and are summarised as follows:

- It was observed that poor construction or lack of maintenance often resulted in essential features of the VIP latrine design being missing or damaged, including vent-pipes, flyscreens, pedestal lids, doors and back plates. Under these conditions, there were usually problems with odours and flies.
- Bad user habits resulted in rapid accumulation of pit contents, particularly when poorly degradable anal cleansing material such as magazines, plastic bags or stones were used. In many cases pit latrines appeared to double as waste disposal sites, resulting rapid filling of the latrines.
- During pit emptying operations, significant risk of infection of workers and community members with human pathogens originating from the pit contents is expected due to difficulties in removing pit latrine contents and separating faecal sludge from solid waste.

It was concluded that certain targeted interventions could improve the ability of the VIP to provide an improved sanitation service to the users of the latrine:

- Design changes relating to the volume of the pit and access to pit latrine contents could reduce the risk of the spread of disease during pit latrine emptying operations.
- User education should be implemented to ensure that pit latrines are properly used and maintained, thereby eliminating many of the problems associated with VIP latrines including flies, odours and rapid filling rates.
- A detailed, budgeted and financed plan to empty pit latrines and manage the exhumed sludge should be in place wherever VIPs form part of a Municipal or government plan for provision of improved sanitation.

A supplementary programme should be in place in communities serviced with pit latrines to ensure that spare parts are available for maintenance of the units, and sufficient expertise may be found within or near to the community to undertake simple maintenance exercises identified by owners of the VIP latrines.

5.2 Commercial pit latrine additives

In this study, no scientific evidence was found to support the hypothesis that the use of commercial pit latrine additives can reduce the rate of filling of pit latrines. It is recommended that the proposed additive testing protocol should form a first step in achieving consensus for further testing of commercial pit latrine additive products.

ACKNOWLEDGMENTS

This report was compiled from a number of reports and dissertations prepared by team members and students from the project team. These are:

Mrs KM Foxon
Mr CJ Brouckaert
Mr D Magagna
Ms C Nwaneri
Ms S Naidoo
Ms E Balboni
Mr RH Salisbury

Other project team members and students whose contributions are gratefully acknowledged include:

Prof Chris Buckley, Dr Nicola Rodda, Prof Mike Smith, Dr Enrico Remigi, Mrs Colleen Archer, Mr Scebi Mkhize, Mrs Anne Bindoff, Mr David Hawksworth, Mr Mikey Guness, Ms Natasha Pillay, Ms Shamsheera Ali, Mr Terry Naidoo, Mr Babatunde Bakare, Ms Fathima Khan and Ms Firdaus Khan.

The project team would like to acknowledge and thank all who assisted the project in anyway, but especially:

The chairman and members of the Reference Group:

Mr Jay Bhagwan, Mr Bill Pfaff, Mr John Harrison, Mrs Siobhan Jackson, Prof George Ekama, Mr Malcolm White, Mr Aussie Austin, Prof Faizal Bux, Mr Dave Still, Mr Hans Salisbury, Mr Nick Walker, Ms Sonja Büning and Prof R Bharuthram

Members of eThekweni Water and Sanitation Services were extremely helpful in facilitating access to communities and information pertinent to the project. Special thanks go to:

Mr Teddy Gounden
Mr Peter Davis
Mr Lucky Sibaya

Staff from UWP consulting were also very generous with time and pit latrine samples:

Mr Garth Dobie
Tyrone Perry

Thanks also to all the manufacturers and suppliers of pit latrine additives who kindly agreed to donate samples of their products to this research.

Thanks are extended to Ms Nichola Brouckaert for assistance in preparing the photographic diary, and to Mr Hans Salisbury and Mr David Still for supplementing project team photographs.

Finally, many thanks are due to the many community members who allowed us to poke around in their pit latrines, ask them questions about their toilet habits, lend us shovels and manpower, guides and interpreters. This research is dedicated to them.

TABLE OF CONTENTS

Executive summary	v
Acknowledgments	xiii
Table of contents	xv
List of Tables	xvii
List of Figures	xviii
1 Introduction	1
1.1 Construction of a VIP	2
1.1.1 The pit	2
1.1.2 Cover slab	2
1.1.3 Superstructure	3
1.1.4 Vent pipe with fly-screen	3
1.1.5 Pedestal, lid and superstructure door	3
1.2 Project aims	3
1.3 Products	4
1.4 Methodology	4
2 Review of existing knowledge on the processes in pit latrines	5
2.1 Biological processes in pit latrines	5
2.1.1 Overview of anaerobic digestion processes	6
2.1.2 Overview of aerobic degradation processes	7
2.1.3 Factors affecting mechanism and rate of natural processes in a pit latrine	7
2.1.4 Effect of anaerobic digestion on pathogens	7
2.2 Non-biological processes in a pit latrine	8
2.2.1 Filling rates	8
2.2.2 Drainage of liquid out of the pit	8
3 Processes in pit latrines	11
3.1 General theory of the processes in a pit latrine	11
3.2 Observations of pit latrine contents	13
3.2.1 Pit latrines in the study areas	13
3.2.2 What is in a pit?	13
3.2.3 What happens to things in the pit?	15
3.3 Measurement of characteristics pit latrine contents	16
3.3.1 Techniques for characterising pit latrine samples	17
3.3.2 Results of studies characterising the contents of pit latrines	17
3.4 Investigation into the processes in pit latrines	20
3.4.1 Hypotheses	20
3.4.2 Definition of a coordinate system for VIPs	21
3.4.3 Materials and methods: Processes in pit latrines	21
3.4.4 Results: Processes in pit latrines	23
3.4.5 Discussion: Processes in pit latrines	28
3.4.6 Conclusions and recommendations: Processes in pit latrines	30

3.5	Effect of additional moisture and alkalinity on anaerobic digestion of pit latrine contents	30
3.5.1	Preliminary investigation into rate-limiting factors in anaerobic digestion	31
3.5.2	Effect of alkalinity and moisture content on anaerobic digestion in a pit latrine	33
4	Investigations into commercial pit latrine additives	37
4.1	Literature review into the effect of additives on pit latrine contents	37
4.1.1	Septic tank additives	37
4.1.2	Studies into the efficacy of pit latrine additives	38
4.2	Inventory of pit latrine additives	39
4.3	Field trial to test the efficacy of pit latrine additives	40
4.3.1	Aims	40
4.3.2	Methodology	41
4.3.3	Results	43
4.3.4	Discussion	44
4.3.5	Conclusions and recommendations: Field Trial	46
4.4	Laboratory-scale testing of pit latrine additive products	48
4.4.1	Protocols for testing pit latrine additives	48
4.4.2	Testing of pit latrine additives using assessment protocols	50
4.4.3	Discussion of laboratory trials on commercial pit latrine additives	56
4.4.4	Conclusions of laboratory trials on commercial pit latrine additives	58
5	Discussion	59
5.1	Processes in a pit latrine	59
5.1.1	Results of investigations into biological processes in pit latrines	59
5.1.2	Rate-limiting factors in digestion of pit contents: effect of moisture content	60
5.1.3	Pathogen viability in pit latrine sludge	60
5.2	Mechanism and efficacy of commercial pit latrine additives	60
5.3	Pit latrine emptying	61
5.4	Design of pit latrines	61
5.5	Important factors for development of policy relating to VIP latrines	65
5.5.1	User education	65
5.5.2	Solid Waste Management	65
5.5.3	Emptying	65
5.5.4	Maintenance	66
6	Conclusions and Recommendations	67
6.1	Processes in a pit latrine	67
6.2	Health risks associated with pit latrine contents	67
6.3	Efficacy and action of additives on processes occurring in pit latrines	68
6.4	Design of pit latrines	69
	References	71
	Appendix A: Photographic Diary	73
	Appendix B: Study into effect of moisture content and alkalinity on gas production rates from pit latrine contents	79
	Appendix C: List of commercial pit latrine additive suppliers	91
	Appendix D: Protocol for testing pit latrine additives	93
	Appendix E: Capacity Building	97

LIST OF TABLES

Table 2.1: Suggested maximum filling rates for design of VIPs (from Franceys et al., 1992)	6
Table 2.2: Pit latrine filling rates (reproduced from Still, 2002, with permission)	8
Table 3.1: Factors that may affect performance of a pit latrine.....	15
Table 3.2: Summary of characteristics of faeces and urine drawn from literature and various sub-studies within this project.....	18
Table 3.3: Summary of characteristics of faecal sludge component of pit latrine contents measured in this study.....	19
Table 3.4: Questions included in questionnaire administered to owners or household members of homes with VIPs used in the study.....	23
Table 3.5: Study A VIP 1: Moisture content and solids analyses. Results are presented as value \pm standard deviation. n=3 for all results reported. TS: Total solids; OS: Organic solids; IS: Inorganic solids	24
Table 3.6: Study A VIP 1: Results of COD analyses reported on wet basis, dry basis and <i>per mass inorganic solids</i> basis. Results are presented as value \pm standard deviation. n=3 for all results reported	25
Table 3.7: Study A VIP 2: Moisture content and solids analyses. Results are presented as value \pm standard deviation. n=3 for all results reported. TS: Total solids; OS: organic solids; IS: Inorganic solids	26
Table 3.8: Study A VIP 2: Results of COD analyses reported on wet basis, dry basis and <i>per mass inorganic solids</i> basis. Results are presented as value \pm standard deviation. n=3 for all results reported	26
Table 3.9: Summary of results from methanogenic activity tests and biodegradability tests on samples from 4 VIPs from Study A: Marian Ridge Township	27
Table 3.10: Moisture content, solids analyses and COD analysis for samples obtained from Tongaat VIP. Results are presented as value \pm standard deviation. n=3 for all results reported. TS: Total solids; OS: organic solids; IS: inorganic solids	28
Table 3.11: Composition of test units testing biogas production from digestion of faeces with and without additional micro-organisms and alkalinity. All test units were prepared in triplicate	31
Table 3.12: Summary of experimental plan (factorial matrix) to assess the effect of additional moisture and alkalinity on the anaerobic digestion of VIP contents. Each cell represents one experiment performed in triplicate containing substrate (15 g VIP solids) and varying amounts of additional water and alkalinity. Mass of alkalinity per bottle is concentration of the stock solution used (S_i ; $i \in [1,5]$) X the volume added. S_1 : 100 mg/l, S_2 : 200 mg/l, S_3 : 300 mg/l, S_4 : 400 mg/l, S_5 : 500 mg/l of NaHCO_3 . T_j is the treatment label ($j \in [1,36]$). Moisture content values presented were those calculated for Trial 2.	34
Table 4.1: List of manufacturers' description of product actions for all commercial pit latrine additives used in this project.	40
Table 4.2: Random allocation of additives and placebos in study pits, weeks 1 to 3	41
Table 4.3: Results of field pit additive trial 27/2/07 - 13/3/07	42
Table 4.4: Change in height of pit contents after 1 week, change between 1 week and 2 weeks and nett change in height (difference between week 2 height and initial height)	43
Table 4.5: Trial 1 (aerobic units): Moisture and COD concentration measured (i) in the bulk sample of pit latrine contents used in trial 1 before the start of the trial (initial), and from the surface of the aerobic units at the end of the aerobic trial (final). Final values are presented as a 95% confidence interval of the mean (number of observations)	53
Table 4.6: Trial 2: Moisture and COD concentration measured (i) in the bulk sample of pit latrine contents used in trial 1 before the start of the trial (initial), and from the surface of the aerobic units at the end of the aerobic trial (final). Final values are presented as a 95% confidence interval of the mean (number of observations).....	56

LIST OF FIGURES

Figure 1.1: Photograph of a poorly maintained, overflowing pit latrine, filled with non-biodegradable material.	1
Figure 1.2: Basic structure of a VIP	2
Figure 3.1: Diagram of a pit latrine showing the different theoretical layers (i) fresh stool; (ii) partially degraded aerobic surface layer; (iii) Partially degraded anaerobic layer beneath surface; (iv) completely stabilised anaerobic layer.	12
Figure 3.2: (a) photograph of the inside of a pit latrine located on a steep well-drained slope in Marian Ridge community near Mariannhill, eThekweni Municipality; (b) photograph of contents of pit latrines extracted during a pit emptying exercise in near Tongaat, eThekweni Municipality	14
Figure 3.3: Coordinate System for a Ventilated Improved Pit Latrine	21
Figure 3.4: Pit latrine contents from (a) Marian Ridge and (b) Tongaat.....	22
Figure 3.5: Gas production from faeces incubated alone, with anaerobic sludge and with both anaerobic sludge and additional alkalinity. Solid lines indicate the mean of 3 replicates. Dashed lines indicate the range of the standard error of the mean.....	32
Figure 3.6: Combined results of cumulative gas production after 40 days from Set 1 experiments	35
Figure 3.7: Cumulative gas production results after 36 days for experiment Set 2 showing dependence of gas production on additional moisture and alkalinity.....	35
Figure 4.1: Laboratory trial 1: Anaerobic set (honey jars sealed with screw-on lids). Average rate of mass loss after 46 days of incubation at 25 °C. Seven pit latrine additives (A to G) were tested in 5 replicates. Controls indicate samples incubated without additional water or chemical/biological additive. Error bars indicate 95% confidence interval on the rate of mass loss.	51
Figure 4.2 Laboratory trial 1: Aerobic set (open honey jars). Average rate of mass loss after 46 days of incubation at 25 °C. Seven pit latrine additives (A to G) were tested in 5 replicates. <i>Contr</i> indicate samples incubated without additional water or chemical/biological additive. <i>Water</i> indicates samples to which tap water only was added. Error bars indicate 95% confidence interval on the rate of mass loss.	51
Figure 4.3: Trial 1 (Aerobic units): Cumulative mass lost from treatments A to G and water reference compared to similar mass loss data from control units. Each graph shows data from 5 replicates of each treatment.....	52
Figure 4.4: Laboratory trial 2: Aerobic set (honey jars sealed with screw-on lids). Average rate of mass loss after 46 days of incubation at 25 °C. Seven pit latrine additives were tested in 3 replicates. <i>Control</i> indicate samples incubated without additional water or chemical/biological additive. <i>Water</i> indicates samples to which tap water only was added. Error bars indicate 95% confidence interval on the rate of mass loss.....	54
Figure 4.5: Trial 2: Cumulative mass lost from treatments B, C, G, and H to K and water references compared to similar mass loss data from control units. Each graph shows data from 3 replicates of each treatment.....	55
Figure AB.1: Cumulative gas production during the first batch of experiments, Set 1. (i.e. selected experiments with high expected gas production and experiments with no additional alkalinity). Error bars represent the standard deviation for each experiment calculated from the three replicates of the experiment.	81
Figure AB.2: Cumulative gas production during the second batch of experiments, Set 1 (i.e. remaining experiments with high expected gas production). Error bars represent the standard deviation for each experiment calculated from the three replicates of the experiment.....	82
Figure AB.3: Cumulative gas production during the third batch of experiments, Set 1 (i.e. experiments with low expected gas production). Error bars represent the standard deviation for each experiment calculated from the three replicates of the experiment.	83

Figure AB.4: Combined results of cumulative gas production after 40 days for Batches 1, 2 and 3 from Set 1	83
Figure AB.5: Gas production from experiment T ₁₆ from batch 1 and 2.....	84
Figure AB.6: Results of PHREEQ simulations of CO ₂ absorption and variation in gas production due to the absorption in moisture.	86
Figure AB.7: Cumulative gas production results after 36 days for experiment Set 2 showing dependence of gas production on additional moisture and alkalinity.	87

1 INTRODUCTION

Ventilated improved pit latrines (VIP) are an accepted basic sanitation delivery option and are the regulated minimum acceptable level of sanitation in South Africa.

These systems are being installed without a quantitative scientific knowledge of their operation under South African conditions. The basic processes occurring in a VIP are filling (with faecal, water and other material), water transfer into and out of the pit, biological transformation and pathogen deactivation. In general, the rate of filling of the pits as a function of local conditions is not well known; neither is there a good understanding (at least at a policy-making level) of what the condition of the material in the pits will be when the pits become full.

In principle the rate of degradation or leaching of the material in a pit should be similar to the rate of filling thus providing a long service life for the pit. In practice, it is often observed that pits may fill rapidly, particularly if a significant portion of the material added to the pit is non-degradable (Figure 1.1). Management of full pits poses a number of complex challenges to policy-makers, local authorities and householders since households or communities with full pits are no better off than those with no sanitation at all.



Figure 1.1: Photograph of a poorly maintained, overflowing pit latrine, filled with non-biodegradable material.

One of the solutions proposed for management/disposal of pit latrine sludge is the use of a range of commercial products hereafter referred to as pit latrine additives. These may be chemical, microbiological or enzymatic in nature and are marketed on their ability to reduce (or even reverse) the accumulation rate in pit latrines, and reduce potential fly or smell problems. Independent scientific investigations into their efficacy are limited and ambiguous, although there is a vast body of anecdotal evidence that suggests that they have the ability to significantly reduce pit contents, fly and odour problems. Equally, a number of informal studies have suggested that there is no significant benefit to the use of these additives over the addition of water or some essentially inert additive (in effect, a placebo). In many instances, municipalities and other service providers are hesitant to sanction the use of pit latrine additives as they have no scientific basis for choosing one product over another, and are concerned that trials with these products may lead to an expectation among communities that the products will be used forthwith. This in turn could lead to a situation where

political pressure results in the application of expensive products that may or may not have any significant benefit. It is generally felt that a scientific explanation of the mechanism of pit latrine additives, and proof of their efficacy would provide the authorities with the ability to rationally assess the cost-effectiveness of implementing programmes for treating pits with additives.

1.1 Construction of a VIP

For a pit latrine to qualify as a VIP, it must comply with certain requirements; it must (i) provide hygienic separation of human waste from contact with people, (ii) have a vent pipe fitted with a fly-screen to minimise odour and flies; (iii) be built on a secure slab that will resist collapse of the superstructure; and (iv) provide privacy and dignity for the user.

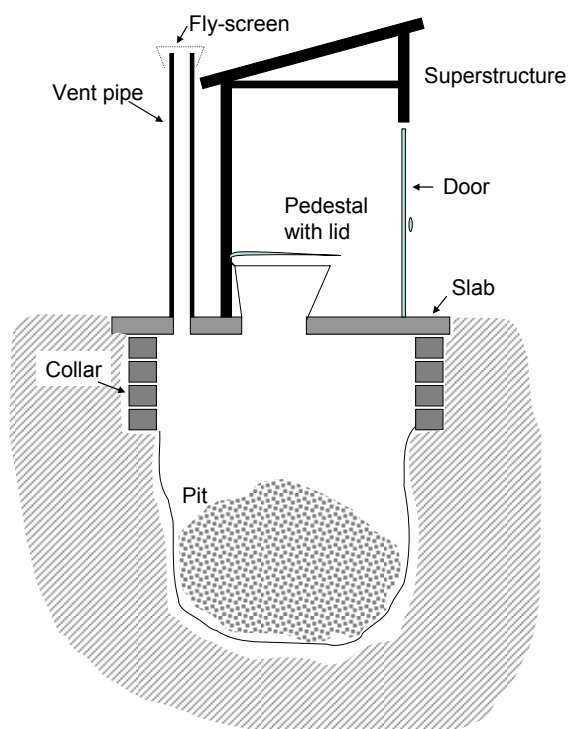

Figure 1.2: Basic structure of a VIP

A typical VIP consists of the following basic features (Figure 1.2): Pit, collar, slab, superstructure with a closing door, vent pipe with fly-screen and a pedestal with a lid.

1.1.1 The pit

The pit allows for the collection of faeces and anal cleansing material, which may then undergo a degree of stabilisation through natural biological processes. The pit may be either a single pit or an alternating twin pit lined with open-joint brickwork or block work. The lining prevents the walls of the pit from collapsing during emptying operations or during heavy rains, while the open vertical joints allow liquid to soak out of the pit into the surrounding soil (Mara, 1984). The pit can be circular or rectangular (Bester and Austen, 2000) and may be built up above the surrounding ground to provide extra depth if the pit is located in an area with shallow bedrock (Bester and Austen, 2000).

1.1.2 Cover slab

This is usually made up of reinforced concrete which covers the pit and has two holes; one for the pedestal, and one for the vent pipe (Mara, 1984). The cover slab serves to support the superstructure and the vent

pipe and also prevent the exposure of faeces to atmospheric air, escape of odours and flies to the surrounding environment.

1.1.3 Superstructure

The superstructure provides privacy to the users, protects the pit from rain and sun, provides enough shadow to the pedestal, thereby preventing flies that are newly formed from leaving the pit itself and also channels air through the pedestal to the vent pipe thereby controlling faecal odours. The superstructure is usually constructed on or around the cover slab, and out of similar materials to the main house of the family to which it is attached.

1.1.4 Vent pipe with fly-screen

The main function of the screened ventilated pipe is to control odour and flies. It is necessary that the screened ventilation pipe stands completely straight in order to allow penetration of light into the pit. The pipe should extend 500 mm above the roof of the superstructure; movement of wind across the top of the vent pipe induces a suction that draws air out of the vent pipe. Flies are attracted to the odours at the top of the vent pipe, but cannot get into the pipe due to the presence of a fly-screen. Since flies are attracted by light, flies that are already in the pit will be attracted to the top of the vent pipe from the inside by the sunlight that shines down the vent pipe, but will not be able to escape due to the presence of the fly-screen. Thus the screened vent pipe should control odours and flies in the pit. (Mara, 1984).

1.1.5 Pedestal, lid and superstructure door

In Southern Africa, pit latrines are commonly built with a pedestal (squat plates or squat holes are more common in central and northern Africa and Asia). A variety of pedestal designs and materials are used, including cement, plastic and porcelain. Cement pedestals are sturdy and fairly inexpensive, but tend to absorb urine and thus the entire superstructure acquires an unpleasant smell over time when these are used. The most important feature of the pedestal is that it should have a lid that does not fit tightly to the seat. The lid prevents the ingress of light into the pit, thus discouraging flies from exiting through the pedestal. However, the lid should not prevent the ingress of air into the pit since suction induced by the movement of wind across the top of the vent pipe will pull air into the pit via the pedestal, thus ensuring odour control.

Similarly, the superstructure should be fitted with a door and roof to keep the latrine dark, further reducing the ingress of light into the pit via the pedestal.

1.2 Project aims

This project proposed to undertake field and laboratory investigations of VIPs and their contents in and around the eThekweni Municipal area in order to understand the conditions to be found in the pits and to propose design and operating practice that will extend the life of pits. The study proposed to concentrate on three main areas of interest:

- Water balance in pits under different hydrogeological conditions (water draining into the pit, water draining out of the pit, no water transfer in or out of the pit)
- Stabilisation rates in pits (organic, pathogens)
- Efficacy and action of additives on pit processes

The project contract specified the following aims for this project:

1. To provide a better quantitative understanding of the microbiological processes occurring in a VIP
2. To guide designers and operators in improving the planning and construction of VIPs.
3. To evaluate the effectiveness of different VIP additives

1.3 Products

The project contract specified the following products for this project:

- An assessment of the effectiveness of VIP additives
- Elementary model of sludge stabilisation in VIPs for estimating the relationship between pit volume and emptying frequency and for guiding sludge disposal
- Identification of success factors for successful sanitation delivery using VIPs
- Risk based assessment of emptying strategies for VIPs

1.4 Methodology

The proposed project methodology indicated that the work of the project should be divided into 2 main focus areas.

The primary aim was to obtain a sound scientific understanding of the mechanisms relating to the transformation of faecal material in pit latrines so as to guide design and operation of the system. A quantitative understanding of the operation of normal operation is necessary before mechanisms and quantitative effect of pit latrine additives can be assessed. This study aimed to look at a range of different VIPs in operation in a number of different areas and observe those factors that could have an effect on the filling rates in the pits. Samples from these pits were to be taken and analysed for composition and biological activity.

The second part of the study was to look at the mechanism and efficacy of pit latrine additives, both in the field, but more specifically under controlled laboratory conditions. This work proposed to develop a protocol for testing the products in order to determine whether there is any possibility that they could be used for controlling filling rates in pit latrines.

2 REVIEW OF EXISTING KNOWLEDGE ON THE PROCESSES IN PIT LATRINES

The term “pit latrine” describes virtually any system that accumulates faecal matter, urine and possibly other material over a period of more than a few days. The design of these systems varies considerably from place to place due to user habits, cultural preferences, available building materials and terrain. A comprehensive literature review of issues relating to design, operation, maintenance, health, social and management aspects of pit latrines is presented in Cotton et al. (1995).

In general, pits are allowed to fill to within a certain proximity to the top of the pit (e.g. 300 mm) and then either emptied by pumping out the contents (or in the case of solid contents, digging out) or buried over. In the latter case, a new pit is dug nearby, and the superstructure moved or rebuilt. A period of stabilisation may be allowed before pit contents are removed, although this is not often the case since alternative sanitation facilities are not usually available where pit latrines are to be dug/pumped out and reused (Franceys et al., 1992).

2.1 Biological processes in pit latrines

The mechanism of treatment in a pit latrine has not been given much consideration in the literature. In general, pit latrines are regarded as accumulation systems, and the fate of the contents thereof is ignored until the pit fills and requires emptying. The few authors who have considered the processes in the pit agree that below the surface of the pit contents, the predominant mechanism of digestion, if indeed any occurs at all is anaerobic digestion (Mara, 1984; Still, 2002; Chaggu, 2004) although aerobic degradation processes may occur at the air interface (top surface).

Mara (1984) describes the mechanism of treatment in terms of two effects:

- Liquid components of the pit infiltrate the surrounding soil. This may cause (structural) instability in the ground in which the pit is located. Groundwater contamination may result. (Mara, 1984; Franceys et al., 1992)
- Anaerobic digestion converts solids originating from faeces to (i) gases: carbon dioxide (CO₂), methane (CH₄) and hydrogen sulphide, (H₂S) that leave via the vent pipe; and (ii) to soluble products that drain away with the liquid content of the pits. (Mara, 1984; Franceys et al., 1992).

Franceys et al. (1992) further state that residence in the pit has a sanitising effect on pathogens, since they are not able to survive during the decomposition processes due to changes in temperature (high temperatures during composting are mentioned) and moisture.

Franceys et al. (1992) indicate that any available oxygen will result in aerobic conversion processes occurring.

The extent of conversion of biodegradable organic material to biomass and gases is called the extent of stabilization; a fully stabilised material has no biodegradable component remaining.

The micro-organisms that degrade organic material in the pit latrine (either aerobically or anaerobically) originate from faecal material, soil, leaves, or from faecal sludge added to or left in a pit that has been emptied. The rate of treatment is dependent on (among other factors) the number of degradative micro-organisms in the pit. A number of authors have suggested that the rate of stabilisation of pit contents,

particularly during the early filling days of a pit can be enhanced by adding extra sources of micro-organism, such as soil or leaves (Still, 2002; Morgan, 2004). If a pit is to be emptied, it is therefore a good idea to leave a portion of the partially digested pit latrine contents rich in anaerobic micro-organisms as a seed for a new anaerobic population to grow (Henze et al., 1997). It is believed that stabilisation of unlined pits usually begins at the walls and gradually moves inward (Still, 2002; Morgan, 2005), indicating that contact with the soil walls provides good conditions for stable digestion. This may be attributed either to seeding from the walls, or the provision of micro-environments that shelter more sensitive micro-organisms from bulk conditions. Morgan (2005) claims that addition of soil, ash and kitchen wastes accelerates decomposition of latrine contents, but does not identify what the specific effect of each is.

Still (2002) reported that an abandoned, lined pit had not reached complete stabilisation after 5 years, and this was attributed to anaerobic conditions and isolation of the pit contents from the soil by the lining.

Studies indicate that substantial volume reduction can be obtained in a pit latrine as a result of natural processes. Puddifoot (1995, in Pitnet, 1996) reported that in a study of 176 VIPs located in Pakistani refugee camps, reduction in volume of material due to decomposition ranged from 50 to 80%. Franceys (1992) surveyed a number of sources and from the presented data, it may be concluded that approximately 1 ℓ of excreta is produced per person per day (although the actual amount depends significantly on the age of the person, the climate and diet) of which between 10 and 40% may be faeces. However, pit latrine filling rates are reported to range from 10 to 120 ℓ per person per year (Still, 2002), including the contribution of anal cleansing material and other household waste. Clearly, even if all liquid drains out of the pit, some reduction in solids volume must be achieved through natural biological processes. Table 2.1 shows filling rates that may be used for designing VIPs under wet or dry conditions, and where degradable or non-degradable anal cleansing material is used.

Table 2.1: Suggested maximum filling rates for design of VIPs (from Franceys et al., 1992)

Conditions in pit	Sludge accumulation rate (ℓ/person.year)
Wastes retained in water where degradable anal cleaning materials are used	40
Wastes retained in water where non-degradable anal cleaning materials are used	60
Wastes retained in dry conditions where degradable anal cleaning materials are used	60
Wastes retained in dry conditions where non-degradable anal cleaning materials are used	90

2.1.1 Overview of anaerobic digestion processes

During anaerobic digestion, i.e. in the absence of oxygen, micro-organisms consume and grow on organic material, converting biodegradable components in the pit into carbon dioxide (CO₂) and methane (CH₄) gases and inert residue. Anaerobic digestion processes require the establishment of a stable consortium of anaerobic micro-organisms since anaerobic digestion occurs in a series of steps, each mediated by a different category of micro-organisms. During anaerobic digestion processes, most biodegradable organic material is converted to gases, while only a small amount (typically 10%) becomes new cell mass through growth of the micro-organisms (Speece, 1996).

2.1.2 Overview of aerobic degradation processes

Aerobic degradation is the consumption of biodegradable organic material in the presence of oxygen. Aerobic digestion processes are far more rapid than anaerobic digestion processes and can be performed by a wide range of naturally occurring micro-organisms (Henze et al., 1997). The products of aerobic digestion are CO₂ gas, new cells and small amounts of other chemical and biochemical by-products. Aerobic digestion by micro-organisms typically has cell yields in the order of 45 to 80% on a COD basis. The rate of aerobic digestion is limited by one of three factors: (i) the number of aerobic micro-organisms present, (ii) the slowest biochemical step in the digestion process, hydrolysis of large molecules to smaller molecules and (iii) the rate at which oxygen can be supplied to the place in which digestion occurs.

2.1.3 Factors affecting mechanism and rate of natural processes in a pit latrine

In order to understand the mechanism of treatment, the following features of construction, operation and maintenance must be studied and understood:

- Construction and location
- Construction of walls and base of the pit
- Permeability of the walls and base of the pit (in lined pits)
- Construction of slab and superstructure of the latrine (does it allow water ingress?)
- Height of water table (low/high)
- Type of soil
- Presence of bedrock or sandy aquifer
- Proximity of other pits
- Operation
- Age of the pit
- Rate of filling / number of users
- Anal cleansing material
- Addition of other material (e.g. household waste)
- Ingress of (non-urine) liquid via the top of the pit
- Maintenance
- Frequency/history of emptying
- Amount of seed material left after emptying
- Additives used to enhance digestion

(Compiled from Mara, 1984; Franceys et al., 1992; Cotton et al., 1995; Norris, 2000; Still, 2002)

Pit latrines can be regarded as fed-batch accumulation systems; slow accumulation of faeces, urine, water, anal cleansing material, and (depending on user habits) sand, leaves or household waste provide a constant flow of organic substrate for anaerobic digestion (Chaggu, 2004). Micro-organisms in the faeces, leaves, sand, previous pit contents or specifically added to the pit are the biological catalysts of the process, and CO₂ and CH₄ are the continuous gaseous products of the system.

2.1.4 Effect of anaerobic digestion on pathogens

In a conventional anaerobic digester (a closed reactor that degrades organic material by biological means in the absence of oxygen), the concentration of viable pathogens reduces during treatment, but complete sterilisation, or reduction of pathogens to levels that are safe for human contact is not possible without some additional treatment. Faecal coliform average survival time in wet sludge at 20 to 30°C has been found to be <50 days (Strauss and Blumenthal, 1997, in Chaggu, 2004). Mesophilic anaerobic digesters (operated between 25 C and 37 C) reduce the number of bacteria, parasite eggs, viruses and other pathogenic organisms in the effluent of UASB reactor by approximately 90% (Feachem et al., 1983), with higher temperatures resulting in more rapid die-off. Feachem et al. (1983) report that death rates for faecal indicator

bacteria will increase with temperature, and increase with decreasing moisture content. The rate of pathogen deactivation also depends on the pH value in the treatment system. A thorough review of pathogen die-off in septic and subsurface soakaway systems may be found in the USEPA Onsite wastewater treatment systems manual (USEPA, 2002).

Feachem et al. (1983) conclude that pit latrine contents that have been left undisturbed for one year would be virtually pathogen free “apart from a few *Ascaris* eggs”. However, these authors caution that the top layer of the pit contents of a pit in use will contain pathogenic micro-organisms, irrespective of the rate of die-off or the overall age of the pit. Cotton et al. (1995) quote a review by Lewis in which the key findings were that 2 m of sand and loam between the bottom of a pit and the water table is enough to remove all bacteria, virus and other faecal organisms

2.2 Non-biological processes in a pit latrine

Two physical processes of a pit latrine can be characterised: (i) the filling of the pit with waste; and (ii) the hydraulic flow patterns into and out of the reactor via the walls and base of the pit.

2.2.1 Filling rates

There have been several studies on pit filling rates. Still (2002) reviewed four studies (three in South Africa, including Norris (2000) and one in Tanzania and Botswana). Reported filling rates varied from 10.0 to 120.5 ℓ /(ca.annum) (litres per capita per annum). The most important factors affecting these rates were understood to be drainage from the pit and the extent to which pits are used for disposal of other household waste. Number of users was also stated to be a factor; it is assumed that the number of users affects the net filling rate (ℓ /annum) but has no effect on the specific filling rate (ℓ /ca.annum).

Table 2.2: Pit latrine filling rates (reproduced from Still, 2002, with permission)

Location	Age of Latrines	Number of Sites	Number of Visits	Avg. Pit Volume m^3	Range of Filling Rates ℓ /ca/annum	Mean Filling Rate ℓ /ca/annum
Soshanguve	approx. 3 years	11	14 over 28 months	1.96	13.1 to 34.0	24.1
Bester's Camp	four years	159	2 or 3 over 25 months	3.16	18.3 to 120.5	69.4
Mbila	approx. 5 years	11	1	2.83	10.0 to 33.2	18.5
Gabarone, Dar es Salaam	not stated	not stated	not stated	not stated	25 to 30	27.5 (implied)

In a study at Besters Camp, near Durban referenced in Still (2002), a 33% decrease in filling *rate* was observed in pits over the 25 month study period for a sample of 159 pits. This was attributed to an increase in stabilisation rate with time.

Still (2002) also reported that in all pits, the disposal of household solid waste in the pit including rags, cloth, plastic and glass contributed significantly to the rate of sludge accumulation, by as much as 10 to 20%.

2.2.2 Drainage of liquid out of the pit

The flow of water in and out of the pit via the walls and base depend on the construction of the pit and the hydrogeology of the surrounding area (Franceys et al., 1992; Cotton et al., 1995). In a sealed pit where the integrity of the lining is not in any way compromised, the only liquid flow should be associated with urine and

faeces entering in the prescribed fashion. These systems are nevertheless vulnerable to addition of water through abuse by the users, or from rain as a result of poor superstructure design.

In unlined pits, or lined pits that are not sealed, three possible scenarios are proposed to describe movement of liquid in and out of pits:

1. Where the water table is lower than the height of the pit contents, and the surrounding soil is permeable, liquid, carrying pathogens, organic material, grease and nutrients will leak out of the pit. The transport of this seepage will depend on the hydrogeology of the area in which the pit is located, and could have serious implications for ground and surface water quality and human health. Contamination usually occurs in distinct plumes around the source, and the impact of the contamination will depend on the positioning of sensitive points (ground water, surface water, springs) in relation to the plume (Franceys et al., 1992).
2. In areas with a water table that is higher than the base of the pit, transfer of liquid in and out of the pit will occur. This may result in a fairly constant level being maintained in the pit as ground water percolates in, or pit contents seep out, depending on their relative heights. In this case, there is a high mobility of nutrients and pathogens from the pits in the surrounding soil.
3. If the pit is located in a rocky area or a soil with high clay content, liquid may be retained in the pit, or drain along a very clearly defined fault.

The moisture content faecal sludge in a pit latrine will affect the rate of degradation that occurs in the pit latrine. While no studies have been undertaken on the effect of moisture content on anaerobic digestion of pit latrine contents, a study of the influence of moisture content on the methanogenic activity in the anaerobic digestion of wastewater treatment plant sludge cake showed that methanogenic activity dropped from 100% at a moisture content of 96% to 53% of the maximum activity when the moisture content was reduced to 90% (Lay et al., 1997). A similar relationship is expected to exist between biodegradation rate and moisture content in pit latrine contents, which are typically found at much lower moisture contents than those used in the study of Lay et al.

3 PROCESSES IN PIT LATRINES

The information presented in Chapter 2 provides some insight into the management of pit latrines from a practical perspective. However, the formal scientific literature yields very little information on the processes that occur within a pit latrine, and specifically on the relative importance of the different categories of processes that occur. Based on a critical review of the available literature, discussions with experienced pit latrine practitioners (including people involved in designing, building and emptying pit latrines) and the results of the various studies that were undertaken as part of this project, a general theory of what happens in a pit latrine was developed. This theory is presented below, followed by the findings of the studies within this project and their contribution to the general theory of processes in pit latrines.

3.1 General theory of the processes in a pit latrine

In order to understand what occurs in a pit latrine, it is necessary to have an appreciation of what pit latrine contents consist of and what kinds of conversion processes can occur in the pit latrine.

Between 75% and 80% of the mass of faeces from a relatively healthy individual is moisture. This is slightly more than the amount of moisture commonly measured in VIP sludge. Up to 80% of the organic material in faeces is biodegradable. Faeces contain a large mass of active micro-organisms (up to 30% of the mass of faeces on a dry basis), and some portion of the rest of the organic material may be considered to be readily biodegradable. The remainder of the biodegradable material will be slowly biodegradable, i.e. will undergo relatively slow conversion processes before being completely degraded within the pit latrine. A substantial portion of the faecal material will consist of intact cellular material. This may be from active micro-organisms that make up the 30% reported above, from dead or inactive micro-organisms originating from the digestive system, or the cellular matter may originate from partially digested plant or animal tissue that has formed part of the diet of the person producing the faeces.

It appears that when faeces are added to a pit latrine, they undergo a period of rapid degradation in which micro-organisms present in the faeces and those present on the surface of the pit latrine contents cause rapid aerobic degradation of readily biodegradable organic material. Thus a considerable portion of the biologically degradable portion of faeces disappears through aerobic bioconversion processes as it lies on the surface of the pit contents.

Since the rate of accumulation in the pit is slow relative to the rate of degradation in this first rapid degradation phase, the amount of material on the pit surface that can be considered to be similar in composition to fresh faeces is negligibly small compared to the amount of material accumulated in the pit. The readily biodegradable components in the faeces have thus already been consumed on the surface of the pit contents.

In a well-designed pit latrine, there is a constant motion of air through the pedestal, into the pit and out of the vent pipe. Thus there is a constant supply of oxygen to the top surface of the pit contents through contact with air, and aerobic processes may occur in the top layer of pit latrine contents. Except for an area of a few square centimetres on the top of the pile, the pit latrine contents at the surface will have little further readily biodegradable material present. The presence of oxygen at the surface will therefore facilitate further, slow aerobic degradation of some of the remaining slowly biodegradable components. During aerobic degradation, organic material is converted to carbon dioxide and new micro-organism cell material.

Once organic material has been covered over by new pit contents, the material becomes anaerobic through lack of oxygen, and the rate of degradation drops dramatically. This is due to two effects. Firstly, readily biodegradable organic material has been depleted; secondly, anaerobic digestion processes, i.e. those that

occur in the absence of oxygen, take place at a much slower rate than aerobic processes. Once pit contents have resided for a sufficiently long period in the pit, they become fully stabilised, i.e. the amount of degradation that will occur within their remaining residence time in the pit is negligible; this is true of pit contents located deep in the pit.

Thus the faecal sludge portion of pit contents may be divided into four theoretical categories (Figure 3.1): (i) the first category is sludge where readily biodegradable components are still present, wherein rapid aerobic degradation occurs. This layer is negligibly small and is not measurable in practice; (ii) the second category is made up of the top aerobic section of the pit. In this layer, aerobic degradation of hydrolysable organic material occurs at a rate limited by the aerobic hydrolysis of complex organic molecules to simpler compounds; (iii) the third layer is anaerobic due to the occlusion of oxygen by covering material. Anaerobic digestion proceeds at a significantly slower rate than in the layer above, and is controlled by the rate of anaerobic hydrolysis of complex organic molecules to simpler molecules; and (iv) in the lowest layer, no further stabilisation of organic material occurs within the remaining life of the pit contents.

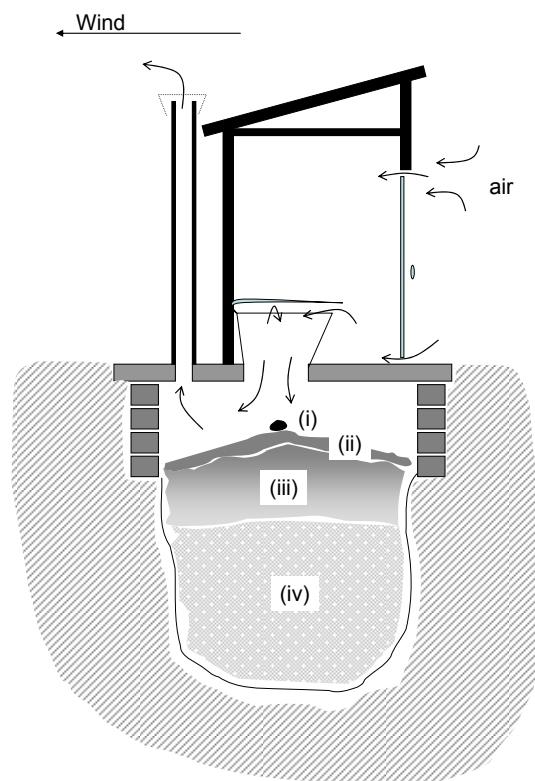

Figure 3.1: Diagram of a pit latrine showing the different theoretical layers (i) fresh stool; (ii) partially degraded aerobic surface layer; (iii) Partially degraded anaerobic layer beneath surface; (iv) completely stabilised anaerobic layer.

This theory challenges the original concept that a pit latrine operates as a large, mixed and inefficient anaerobic digester, and that significant amounts of methane gas may be produced from the pit contents. According to this theory, much of the degradation which occurs is aerobic, and therefore will not produce methane gas.

A further component of the general theory of processes in pit latrines relates to the kind of material that exists in layers (iii) and (iv) of Figure 3.1. Much of the organic material that remains after the initial aerobic degradation that occurs in the upper layers is dead cell matter originating from the original faecal material, or from micro-organisms that were active in layers (i) and (ii) but which became inactive after burial by fresh pit

contents. Cell components, particularly cell walls and membranes tend to be difficult to degrade, and may exist intact or semi-intact for a long time. Furthermore, a significant portion of these components are completely non-degradable. Therefore, this general theory suggests that biological processes in layers (iii) and (iv) are dominated by the slow breakdown of poorly degradable cell components, with very little conversion of organic material to methane gas. In degrading intact, but inactive cells, moisture that has been locked into the cell by containment within the cell membrane is released, and may drain away. This results in a slow dehydration of buried pit contents through a combination of biological and physical processes.

The theory presented above has been suggested by the results obtained in this and other projects. Many aspects of it have not been scientifically proven, but make logical sense given the broader understanding of the nature of faeces and pit latrine contents, and observations of what is found at different depths within pit latrines. In the sections that follow, the studies that were undertaken within this project are presented and the results interpreted in the light of this theory.

3.2 Observations of pit latrine contents

During the planning stages of this project, project aims and methodology were developed based on a fairly naïve perception of what would be found in pit latrines. The purpose of this section is to capture the experiences of the research team relating to what was actually observed in pits to assist in interpretation of experimental results.

3.2.1 Pit latrines in the study areas

This study was limited to pit latrines in the eThekweni Municipal area. eThekweni Municipality is the municipal area encompassing the South African city of Durban, and has a sub-tropical climate. Temperatures vary from 10° C to 33° C. It is a summer rainfall area with minimum monthly rainfall below 30 mm in midwinter and above 130 mm in midsummer. There is a very high prevalence of ascariasis in the population within the eThekweni Municipal area. The full history of the latrines visited and sampled within this study could not always be traced because they had been constructed prior to the formation of the municipality.

3.2.1.1 *Marian Ridge*

The pit latrines in Marian Ridge were built at the same time as the houses. They were privately owned. Both the houses and the VIPs were constructed from clay brick. The pits were located within a few metres of the houses. There appeared to be a relatively high employment rate amongst residents; those at home during the working day were usually older women and children.

3.2.1.2 *Tongaat*

The pit latrines studied in Tongaat were constructed by the health department for informal communities living in shacks on the sand dunes. The latrines were communal units, being shared between up to 12 households. Certain of the latrines had been “taken over” by a sub-group within the community and padlocks had been installed on the latrine doors. The pit superstructures were generally in poor repair, and appeared to have been constructed of cement brick. The community appeared to be very poor, with high levels of unemployment.

3.2.2 What is in a pit?

In many households, a pit latrine serves the dual purpose of providing basic sanitation and storing solid refuse. It has been widely reported in the limited literature on the subject that a large variety of discarded objects and waste are generally found in pit latrines and pose significant difficulties during pit emptying (Mara, 1984; Franceys et al., 1992; Cotton et al., 1995; Still, 2002). Still (2002) reports that 10 to 20% of the pit contents could be made up of non-degradable refuse, although in certain instances, it may be far higher. Every pit latrine that was investigated during the course of this project confirmed this to a greater or lesser extent (Figure 3.2).



(a)



(b)

Figure 3.2: (a) photograph of the inside of a pit latrine located on a steep well-drained slope in Marian Ridge community near Mariannhill, eThekweni Municipality; (b) photograph of contents of pit latrines extracted during a pit emptying exercise in near Tongaat, eThekweni Municipality

Pits contained faeces and anal cleansing material as expected. The latter category included toilet paper (occasionally), newspaper, magazines, stones, rags, plastic bags and chip packets. In addition, vegetable waste, plastic and glass bottles and jars, polystyrene, blankets, hats, underwear, toys and a range of other household objects were regularly observed. There was no particular pattern observed in the distribution of different categories of material within a pit. There did appear to be similarities between the contents of different pits within the same community, although these were not scientifically documented. The implication of this observation is that similar user practices exist within a community, but may differ significantly to those in a different community. It is recommended that a systematic record of observations of this type is undertaken in future research into pit latrines.

Maggots and worms in pit latrine contents could be regarded as another significant category in pit latrines. Although this project was not specifically concerned with counting and identifying macro-invertebrates in pit latrine contents and therefore did not systematically record presence or relative abundance of these pit inhabitants, nevertheless, it was possible to draw some broad conclusions from field observations. Firstly, the presence of significant quantities of maggots, presumably fly larvae, in pit contents appeared to be related to issues of pit design and latrine maintenance; pit latrines that had missing vent-pipes or back slabs, damaged or inadequate back slabs or pedestals, or pedestals with no lid invariably contained significant maggot populations (Section 4.3.5.3). Pit latrines that were constructed in accordance with general guidelines for VIPs (i.e. with a vent pipe, pedestal lid and properly closed back slab) had significantly smaller observable number of maggots.

Many householders have some kind of toilet cleaning routine which may include the use of water and detergents and in some cases disinfectants which ultimately land up in the pit. The frequency and fervour with which the toilet is cleaned may have a significant effect on the contents of the pit;

- the volume of water added may be significant relative to the total volume of liquid added on a daily basis;
- disinfectants may have a significant detrimental effect on biological processes that would otherwise occur in the pit since, by their nature, they inhibit or destroy the micro-organisms that carry out these processes.

The relative quantities and distribution of different categories of material in a pit will have an effect on the processes that occur in the pit. Some possible mechanisms are:

- The presence of large amounts of non-degradable material in a pit has two effects: (i) the pit fills quicker due to the large material addition rate and (ii) the rate at which biodegradable material is covered over in the top layer and therefore deprived of oxygen is increased resulting in lower potential for aerobic degradation during residence in the top layer
- The amount of moisture present in the pit contents will have an effect on both biological and transport processes. Moisture assists in solubilisation of potentially soluble components (including salts, easily digestible organic material and carbon dioxide). It allows movement of soluble components relative to stationary solid components (Martin et al., 2003). It also affects the concentration of dissolved components: addition of water to the pit decreases the concentration of salts and organics leached out of solid material. These concentrations may have a significant effect on the rate of biological activity in the pit, or the extent of microbial inhibition if the latter is caused by a water soluble component.
- The presence of organic material in the pit from e.g. disposal of kitchen refuse or addition of soil will contribute to the load and diversity of micro-organisms in the pit and assist in the establishment of a healthy natural micro-organism population in the pit provided that pit conditions are conducive to such.

In summary, it is not possible to predict what will be in any particular pit without at least looking into the pit, or digging the contents out. Considerable variability may be expected in organics content, moisture content, non-biodegradable content and micro-organism population.

3.2.3 What happens to things in the pit?

What is added to a pit depends mostly on user habits and to a lesser extent on the physical design of the structure. What occurs in the pit depends to on the same two factors; in addition, the geo-hydrology of the locality of the pit will also affect the processes that occur therein.

An important step in developing a strategy for improving the design and operation of pit latrines is to understand what processes occur in the pit, how they occur, and what factors will affect the rate at which they occur. Once the processes are understood, it becomes possible to propose methods of enhancing the processes either through the addition of chemical or biological agents or through simple design changes.

Examination of available literature has indicated that certain factors may have a significant effect on the performance of a pit latrine). These are summarised in Table 3.1.

Table 3.1: Factors that may affect performance of a pit latrine

Construction and location	Operation	Maintenance
Construction of walls and base of the pit	Age of the pit	Frequency/history of emptying
Permeability of the walls and base of the pit	addition of other material (e.g. household waste)	Amount of seed material left after emptying
Construction of slab, collar and superstructure of the latrine	Ingress of (non-urine) liquid via the top of the pit	Additives used to enhance digestion
Height of water table (low/high)	Rate of filling / number of users	Ownership: Communal or private
Type of soil	anal cleansing material	
Presence of bedrock or sandy aquifer		
Proximity of other pits		

From the literature review, the following possible effects may occur in the pit:

- *Accumulation*: Material that does not degrade or drain out of the pit will accumulate and cause the volume of pit contents to increase.

- *Aerobic degradation:* In the presence of oxygen and appropriate aerobic micro-organisms, biodegradable material will be converted to CO₂, water and more cell mass for the participating micro-organisms
- *Anaerobic degradation:* In the absence of oxygen, and in the presence of appropriate anaerobic micro-organisms, provided that environmental conditions of pH, moisture and other chemical factors are correct, anaerobic digestion of biodegradable organic compounds will occur resulting in the production of intermediate products including soluble organic compounds, especially organic acids and end products including CO₂, CH₄, water, non-biodegradable organic material, NH₄⁺, phosphates and a small amount of new anaerobic micro-organisms.
- *Leaching/drainage:* depending on the type of soil/rock in which the pit is located and the height of the water table, liquid and soluble components may move in or out of the pit. Under many conditions, liquid carrying soluble and suspended material will percolate through the pit contents or out of the pit walls and drain away, resulting in fairly dry pit contents. However, when the water table is high, or there is some other source of moisture above the bottom of the pit (e.g. a tap located near the pit, or movement of water after heavy rains) moisture may move into the pit, bringing in soluble and suspended material from the surroundings.
- *Compaction:* Addition of new material on top of the heap, and degradation of older organic material will result in the compaction of pit material at the bottom of the pit. This may also cause moisture to be squeezed out of the pit contents. Breakdown of intact cells with time will also result in the release of bound moisture, and subsequent compaction of pit contents.
- *Digestion by macro-invertebrates:* Fly larvae and other worm-like macro-invertebrates are observed in the contents of many pit latrines. While not considered a benefit in pit latrines because of their nuisance and health risks, these have two important effects: (i) they digest pit latrine material thereby providing a degree of stabilisation and volume reduction; and (ii) movement of macro-invertebrates in the top layers of the pit latrine contents ensures aeration of a thicker layer than would occur in their absence.

3.3 Measurement of characteristics pit latrine contents

Pit latrine contents are extremely heterogeneous in nature with two consequences: firstly, it is very difficult to obtain a representative sample of the material in the pit or even material in a specific area within the pit (for example, in the top layer) and therefore it is inadvisable to assign a single value to describe any characteristic of the pit; secondly, should a probable range of values for any measurement be obtained for one pit, it cannot be assumed to apply equally to another pit. Nevertheless, it is necessary to have some idea of what the characteristics of pit latrine contents are for a number of reasons:

- To shed light on the nature and extent of chemical and biological changes that may have occurred in a pit latrine with time;
- To assess possible disposal options;
- To assess health and environmental risks relating to the handling and disposal of the material.

This section contains a summary of the different characteristics measured in samples obtained from pit latrines during the course of this project.

3.3.1 Techniques for characterising pit latrine samples

Where appropriate, Standard Methods (APHA, 1998) have been used to analyse the pit latrine samples. Where no appropriate method was published, adaptations of existing methods or entirely new methods were developed. Each methods and the principle behind the measurement is presented here.

3.3.1.1 COD

Chemical oxygen demand (COD) measures the amount of oxygen required to completely oxidise a sample of organic material to CO₂, H₂O and NH₃. It is a measure of the organic material in a sample that is not dependent on the chemicals that make up the material. It does not provide an indication of the biologically available organic material in the sample, but is simple and accurate to measure, and therefore is regarded as a reliable indicator of organic content. It is also a useful indicator of the energy required to stabilise the sample. COD was measured for whole (unfractionated) samples and for filtrate of filtered samples, or supernatant of centrifuged samples. The last two measurements were used as an indication of the dissolved organic material in the sample. COD was measured using the open reflux method for particulate samples and the closed reflux (titrimetric) method for soluble or filtered samples according to Standard Methods (APHA, 1998).

3.3.1.2 Biodegradability

The serum bottle technique (Owen et al., 1978) was used to measure the amount of anaerobically biodegradable COD in a sample. The sample to be analysed was incubated in a 125 ml serum bottle with a portion of healthy anaerobic sludge, with a non-limiting supply of nutrients and the biogas production quantified. The biodegradable COD fraction was calculated from the difference in methane production from bottles containing sample, and control bottles that contained only anaerobic sludge and nutrient solution.

3.3.1.3 Characterisation of solids

Measurement of total solids and organic solids were performed according to Standard Methods (APHA, 1998). The difference between wet and dry solid masses recorded in the total solids analysis was the moisture content of the sample. Pits situated in locations with well-drained sandy or fractured rock geology are likely to have low moisture content, while pits built in clay, or in areas with a high water table are likely to retain considerably more moisture.

3.3.1.4 Anaerobic Activity

Simple gas production measurements from samples that were anaerobically incubated in serum bottles (without additional biomass or sludge) were obtained. These indicate baseline anaerobic activity in samples without any intervention.

3.3.1.5 Methanogenic Activity

Measurements of methane production rate were obtained from samples that were anaerobically incubated in serum bottles (without additional biomass or sludge) were obtained by measuring the total gas production rate and the methane composition. The methane production rate was calculated by mass balance using the same method as for biodegradability (section 3.3.1.2)

3.3.2 Results of studies characterising the contents of pit latrines

Faeces do not have well defined characteristics, but will depend on the diet and general state of health of the person who produced them. This study investigated characteristics of fresh faecal material and samples obtained from pit latrines. The purpose of the study was to obtain detailed characterisation of both faecal material and pit latrine samples to develop a sense of what the major differences between the different types of faecal sludge are, and what might have caused them (i.e. what happens to the material in the pit). In contrast to other parts of the study, a differentiation was made between particulate and soluble characteristics. It was acknowledged from the beginning that the faeces used in this study may not have been similar to those that went into the pits from which samples were drawn.

This section presents data from studies extracted from the literature, and from within this project, in order to provide a comprehensive picture of the chemical characteristics of pit latrine contents. Most information is available for COD analyses since this measurement is easy to perform with a reasonable degree of accuracy, and provides a good indication of the progress of biological processes.

3.3.2.1 Characterisation of faeces and urine

It is usually assumed that the major components of a pit latrine that contribute to the organic content of the pit are urine and faeces. It is useful to have an idea of the characteristics of these components as they are added to the pit. This provides a point of comparison against which to assess the results of pit contents characterisations.

A number of literature sources provide information on the characteristics of urine and faeces. (Chaggu, 2004) presents a survey of available literature on the chemical composition of urine and faeces. Additional data has been obtained from Palmquist and Jönsson (2003) and Lopez Zavala et al. (Lopez Zavala et al., 2002), and the combined data is presented in Table 3.2.

Table 3.2: Summary of characteristics of faeces and urine drawn from literature and various sub-studies within this project.

Source		L Z ¹	Chaggu	P & J ²	This study					
					Ave ³	min ⁴	max ⁵	C of V ⁶	No. ⁷	
Component	Unit	Feaces	Faeces	Urine	Faeces	Faeces				
Total mass (wet)	g/day		70-520	1000-1500	199	-	-	-	-	-
Moisture % of wet mass	g H ₂ O/g wet mass	81.8	66-85	93-99.5	86	75.5	70.8	79.6	4.9%	12
Total COD	mgCOD/g wet mass		46-78	-	51	354	318	449	18%	12
	mgCOD/g dry mass	1 450	253 ⁸	-	364 ⁹	1 448	1 308	1 579	9.0%	12
Organic solids	g OS/g TS %	84.4	-	-	-	69	16	89	51%	12
Total K	gK/gTS %		0.8-2.1	2.5-3.7	2.8	-	-	-	-	-
Total S	gS/gTS %		-	-	0.77	-	-	-	-	-
Total N	gN/gTS %	6.0	5.0-7.0	15-19	7.0	-	-	-	-	-
Total P	gP/gTS %	0.45	0.69-2.5	1.08-2.2	2.5	-	-	-	-	-
Biodegradability	mgCOD/mgCOD %	80	80 ¹⁰	-	-	74 ⁺¹¹	-	-	-	1

¹ Lopez Zavala et al. (2002)

² Palmquist & Jönsson (2003)

³ Average measurement

⁴ Minimum measurement

⁵ Maximum measurement

⁶ Coefficient of Variation (Standard deviation/average%)

⁷ Number of observations

⁸ Calculated from midpoint of each of moisture and COD ranges

⁹ Calculated

¹⁰ Zovala-Lopez et al., 2004

¹¹ Experiments were still producing small amounts of methane and hence not all biodegradable material is measured in this value

Studies that were undertaken by Lopez Zavala et al. (2002; 2004) to characterise faeces and to describe the biodegradability of organic matter present in faeces showed that 80% of human faeces comprised of slowly biodegradable organic matter (X_S) whereas only 20% is inert material (X_I). Readily biodegradable organic matter (S_S) was not regarded as a component of faeces (i.e. =0%).

The slowly biodegradable portion cannot be utilised directly by micro-organisms and so have to be made accessible through extra-cellular hydrolytic (enzymatic) reactions (Lopez-Zavala et al., 2004). The kinetics and mechanism of biodegradation of faeces can thus be related to its hydrolysability. Using mathematical modelling, Lopez Zavala et al.(2004) showed that only 15% of the slowly biodegradable was easily hydrolysable (X_{Se}) whereas 65% was slowly hydrolysable (X_{Ss}).

It can be seen that there is a significant difference between values of COD of faeces presented in the literature and those measured in this study. Literature values for faeces given in Chaggu (2004) and Palmquist and Jönsson (2003) are similar to those found for pit latrine contents in this study (see Table 3.3). There are number of possible reasons for this difference: the data obtained by Palmquist and Jönsson (2003) was measured from accumulated material in a urine diverting toilet system after a substantial collection period (1 year). Hence easily degradable COD components may not be included in the analysis. Chaggu (2004) presents data compiled from a variety of sources; it is not known what the source of material is and why the values differ from those measured in this study. However, Lopez Zavala et al. [Lopez Zavala, 2002} found similar values for COD content of faeces to that measured in this study. These authors used fresh faeces in their analyses. Faeces analysed in the course of this project came from a variety of donors, but all of these were from the project team or their families and had not undergone long storage periods. These people are not typical of societies that use pit latrines. Hence it is possible that the difference in values may be due in part to a difference in diet.

3.3.2.2 Characteristics of pit latrine contents

Table 3.3 presents a summary of the characteristics of VIP contents measured within this project. Note that for practical purposes, these measurements are for the faecal sludge component of the pit latrine only; i.e. they do not consider items of general household refuse.

Table 3.3: Summary of characteristics of faecal sludge component of pit latrine contents measured in this study.

	Analyte	Units	Average	min	max	n	C of V ¹
Total	COD	mg/g wet weight	105	46	199	21	45
		mg/g dry	445	71	987	17	58
	Moisture	% of wet sample	76	29 ²	81	13	6
	Total Solids	% of wet sample	33	19	71	17	54
	Organic Solids	% of solids	36	6	62	17	48
	Inorganic Solids	% of solids	64	38	94	17	26
Soluble ³	Biodegradability						
	COD	% of total COD	31	7	91	7	97
	Nitrate	mg N/g wet sample	0.028			1	

¹ Coefficient of variation

² One pit had very low (atypical) moisture content. The results for this pit have been excluded from this analysis, although the minimum value is reported.

³ The soluble fraction was obtained by filtering (0.45 μ m filter paper) or centrifugation (60 min at 4 000 g) of a suspended and macerated sample of pit latrine faecal sludge.

A practical definition was used to differentiate between faecal sludge and household refuse components of the VIP contents; those that could be macerated using a 1.7 l kitchen blender without damaging the blender were considered to be faecal sludge. All other material was removed and considered to be household refuse. No measurements of the relative masses of these two components were made. However, they were observed to vary widely between pits.

There is clearly considerable variability in pit contents characteristics as shown by the very large difference between minimum and maximum observed values for all determinants. However, it was observed that the average values reported here were typical of a large fraction of the pits investigated, and may be considered reasonable values to use for estimating solids and COD loads in pit latrine material.

There is a clear difference between COD load per mass of dry solid for faeces and pit latrine sludge as measured in this study. If it is assumed that the majority of COD added to the pit originates from faeces, the implication is that a considerable amount of organic material is degraded or volatilises in the pit, before it could appear in the samples that were subsequently analysed for COD. Since the variation in COD load per mass of dry pit latrine sludge is relatively small compared to the difference between faeces and pit latrine sludge, the implication is that much of the COD loss occurs soon after the material is added to the pit. This result is one of the key factors that supports the general theory presented in section 3.1; i.e. that a significant portion of biodegradable material in faeces disappears through aerobic degradation processes before it has formed a layer with sufficient volume to be sampled.

3.4 Investigation into the processes in pit latrines

This section summarises the work performed by Magagna and reported in his MSc Eng Thesis submitted for examination at Politecnico di Milano, Milan, Italy in July 2006 (Magagna, 2006). The work was extended by Nwaneri and will be included in her MSc dissertation.

The research investigated the degradation processes occurring in VIP latrines. The aims of this work were to assess:

- Physico-chemical characteristics of pit contents at different points in the pit;
- Biodegradability of pit contents at different points in the pit;
- Methanogenic activity at different points in the pit;

3.4.1 Hypotheses

The research was structured to answer the following questions about the processes in VIPs:

- Is the mechanism predominantly an anaerobic degradation process? No research has been previously carried out in order to determine if the conditions are suitable for anaerobic digestion to take place.
- What is the role of the water? There should be little water added to the pit by the user; the water should be limited to that contained in the faeces and urine or used for cleaning the toilet, although other water may arrive in the pit from other sources.
- What happens to the biologically inert material/compounds that are added to the pit?

It was hypothesised that:

- Biologically inert material that is added to the pit does not degrade and is not transported within the pit or out of the pit (i.e. it remains in association with the solid material with which it was added);
- Water plays a role in the diffusion of organic content.
- The amount of COD (organic content) decreases with the age of the VIP content; therefore lower concentrations of COD are expected at the bottom of the pit.

3.4.2 Definition of a coordinate system for VIPs

It is reasonable to assume that the various mechanisms vary with time and position in the pit. Nevertheless the accumulation and moisture content of VIP contents follow time-dependent paths. The extent of anaerobic digestion of the organic content depends on the age of the content. A deeper sample is also an older sample which has had a longer residence time in which to undergo biological activity and whose characteristics may be affected by the mechanisms that occurred since the solids have been deposited in the pit. Therefore it is necessary to consider the spatial variation in characteristics of pit contents and the interdependence of the age of a sample and its position in the pit.

A coordinate system was defined to correlate the samples and their characteristics with a general VIP latrine and in order to compare the results obtained between different toilets.

It was chosen to use a cylindrical coordinates system, which implied that variations were to be observed in two directions: vertically and radially. This neglects the possibility of horizontal variations as a result of lateral flow of water due to ground water flow and differences in ground conditions on either side of the pit.

The pedestal hole was chosen as the origin of the axes; the vertical axes z extends from 0 at the surface of the pit with increasing value towards the bottom of the pit while the radial axes extend outwards from the vertical axis to the pit wall, parallel to the cover slab. A cross section view of the coordinate system is presented in Figure 3.3.

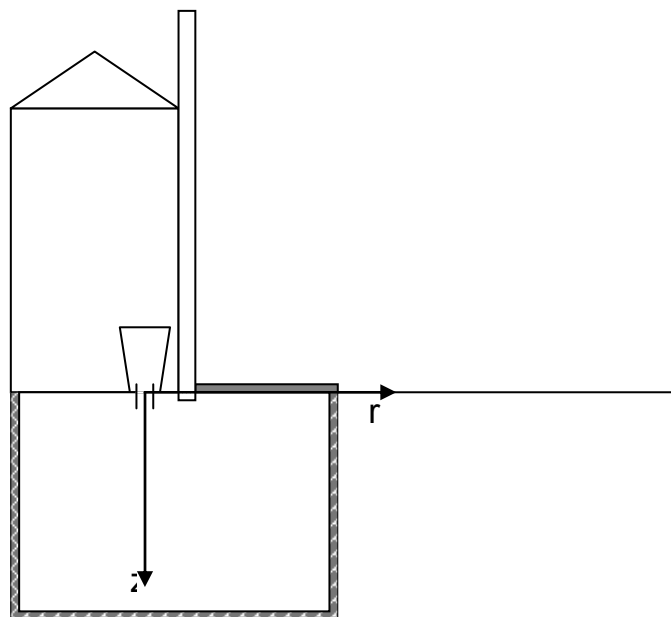

Figure 3.3: Coordinate System for a Ventilated Improved Pit Latrine

3.4.3 Materials and methods: Processes in pit latrines

This study aimed to identify particular physical or biochemical processes taking place in a VIP; and then to identify those mechanisms that have little effect on the removal of solids from the pit and may therefore be excluded from a pit model.

The variables that could hypothetically affect the functions of a VIP include:

- organic load;
- percolation, described as the vertical movement of water and soluble components due to the influence of concentration gradients and gravity;

- excess water ingress (e.g. due to heavy rains, dripping taps nearby);
- soil permeability;
- water table level fluctuation and flow direction;
- hydrolysis;
- diffusion, dispersion and advection of the organic load;
- compacting of the material;

A number of different samples were collected from different VIPs and samples were collected from different locations in the same pit.

3.4.3.1 Study site

The study site was located in the Marian Ridge Township, Pinetown, West of Durban. The community was recommended for the investigation by staff from eThekweni Municipality Water and Sanitation Services. The specific area under study was located on a fairly steep hill. Marian ridge site is mostly covered with Natal Sand. The ground around VIPs in this area was therefore assumed to have a high permeability to water. No water table level data for the site under investigation were found. The VIPs had been in use for about 15 years. Samples were collected at different times of the year and in different weather conditions. Samples generally did not appear to be well-degraded, were light brown in colour and contained a significant proportion of solid refuse (Figure 3.4 a).

Four VIPs were selected on the basis of accessibility and fullness; samples of the VIP contents were collected and thereafter examined.

In Ms Nwaneri's work, samples were obtained from a pit that was being emptied during a pit emptying campaign in a community located near Tongaat in the northern reaches of eThekweni Municipality. This area is located very close to the sea (elevation <20m). Pits in this area were fairly old (>10 years) and pit contents were observed to be considerably wetter than those in the Marian Ridge Township. Pit contents (apart from the top layer) were black in colour and had a similar smell to anaerobic digester sludge. (Figure 3.4 b)



(a)



(b)

Figure 3.4: Pit latrine contents from (a) Marian Ridge and (b) Tongaat

3.4.3.2 Data collection

Two types of data were collected: firstly householders were questioned about their perceptions and experience with their VIP; secondly samples were collected from their pits and analysed.

Householder questionnaire

A primary method to gain information used during the course of the research has been to investigate directly with the users of the VIP the state of the toilet with the assistance of a questionnaire was created. All the questions prepared had the aim to focus on the user-related issues and to be the basis from which the results are interpreted (Table 3.4).

Table 3.4: Questions included in questionnaire administered to owners or household members of homes with VIPs used in the study

	Question
1	How many people in the household?
2	How many children?
3	How many are at home during the day?
4	How old it is the pit?
5	Was it recently emptied? If so, when?
6	Have any additives or chemicals been added? If so, when?
7	Do you in anyway adjust the pit to enhance its performance?
8	Did you pour water in it, or any other kind of liquid?
9	Have you experienced any particular problem with the pit (strong smells, and so on) that made you think the pit wasn't working well?

Sampling technique

Two different categories of sample were collected; homogeneous samples and location-specific samples:

- *Homogeneous samples*: a well mixed sample where the physical/biological characteristics are homogenized in order to represent the pit content on general basis
- *Location-specific samples*: a sample which maintains the in situ characteristics of the location of the pit where it was collected from

Location-specific samples were obtained from the centre of the pit (directly below the pedestal hole) at different heights below the surface and from the side of the pit (near the back plate) at different heights below the surface.

Analyses

- The following analyses were performed:
- Total, organic and fixed solids according to Standard Methods (APHA, 1998) (Section 3.3.1.3)
- Open reflux COD (Samples were suspended in distilled water to obtain appropriate dilutions for the analysis). Results are presented on a per-dry-solids basis to eliminate variability associated with varying moisture content (Section 3.3.1.1).
- Serum bottle tests for the determination of biodegradability of COD adapted from Owen et al. (1978) (section 3.3.1.2).
- Methanogenic activity determined by the rate of methane gas evolved from samples incubated under anaerobic conditions at 35 °C per mass of sample (Section 3.3.1.5).

Where possible, analyses were performed with three or more replicates.

3.4.4 Results: Processes in pit latrines

The results for the two substudies are presented in separate sections. Study A contains the work by Magagne (2006) and study B is the work of Nwaneri (in preparation).

3.4.4.1 Summary of results obtained for study A: Marian Ridge

Complete data for the study may be found in Magagna (2006). The data was analysed using a Student’s t-test to ascertain whether values for measurements obtained for a certain sample were significantly different from values obtained from samples at different locations within the same VIP. The findings may be summarised as follows:

VIP 1

- It was raining heavily on the day of sampling.
- The householder admitted to adding some chemical agent to the pit to control smells, but it could not be ascertained what the additive was.
- Five samples were obtained from the pit: three samples at different heights varying from the surface to about 300 mm below the surface were obtained from the centre of the pit directly below the pedestal hole ($r \approx 0$) and two samples from about 50 mm and 200 mm below the surface at the side of the pit ($r \rightarrow r_{max}$).
- Using a post-hoc Scheffé test, it was found that there was no significant difference between values obtained for moisture content between any of the samples taken at three different heights directly below the pedestal hole ($r \approx 0$), or in the top layer near the side of the pit ($r \rightarrow r_{max}$), but the moisture content of a sample drawn from below the surface at the side of the pit was significantly lower than all other samples analysed.
- The post-hoc Scheffé test indicated that there were no significant differences between any of the organic or inorganic solids measurements.

Table 3.5: Study A VIP 1: Moisture content and solids analyses. Results are presented as value ± standard deviation. n=3 for all results reported. TS: Total solids; OS: Organic solids; IS: Inorganic solids

VIP 1 sample 1 TOP CENTRE		VIP 1 sample 4 TOP SIDE	
Moisture (% g moisture/g sample)	78 ± 0.20	Moisture (% g moisture/g sample)	80 ± 0.8
TS (% g solids/g sample)	22 ± 0.20	TS (% g solids/g sample)	20 ± 0.8
OS (% g OS/g dried sample)	39 ± 5	OS (% g OS/g dried sample)	42 ± 2
IS (% g IS/g dried sample)	61±4.64	IS (% g IS/g dried sample)	58 ± 2
VIP 1 sample 2 MIDDLE CENTRE		VIP 1 sample 5 BOTTOM SIDE	
Moisture (% g moisture/g sample)	80 ± 0.05	Moisture (% g moisture/g sample)	69 ± 1
TS (% g solids/g sample)	20 ± 0.05	TS (% g solids/g sample)	31 ± 1
OS (% g OS/g dried sample)	42 ± 1.5	OS (% g OS/g dried sample)	33 ± 4
IS (% g IS/g dried sample)	58 ± 1.5	IS (% g IS/g dried sample)	67 ± 4
VIP 1 sample 3 BOTTOM CENTRE			
Moisture (% g moisture/g sample)	79 ± 0.11		
TS (% g solids/g sample)	21 ± 0.11		
OS (% g OS/g dried sample S)	40 ± 0.12		
IS (% g IS/g dried sample)	60 ± 0.12		

- The post-hoc Scheffé test indicated that there was a significant difference in amount of COD per mass of dried solids between samples at the side of the pit and those in the middle of the pit, with samples at the side of the pit exhibiting COD values significantly lower than those at the centre of the pit. Note that comparisons are made on a dry basis to eliminate the effect of moisture content dilution of inferred COD concentrations.
- Serum bottle tests over a 90 d period showed that all the samples exhibited an inhibitory effect on anaerobic digestion (Table 3.9). No measurement of biodegradability could therefore be obtained. The

observed inhibition was attributed to the chemical agent added to the pit by the householder. Standard and control samples which are prepared for comparison purposes without VIP sludge as part of the serum bottle test produced the anticipated amount of methane gas.

Results for Moisture content and solids analyses for VIP 1 are presented in Table 3.5. Results of COD analysis are presented in Table 3.6

Table 3.6: Study A VIP 1: Results of COD analyses reported on wet basis, dry basis and *per mass inorganic solids* basis. Results are presented as value \pm standard deviation. n=3 for all results reported

VIP 1 sample 1 TOP CENTRE		VIP 1 sample 1 TOP SIDE	
COD (mg COD/ g sample)	79 \pm 3	COD (mg COD/ g sample)	46.0 \pm 3
COD (mg COD/g dried solids)	367 \pm 16	COD (mg COD/g dried solids)	232 \pm 16
COD (mg COD/g inorganic solids)	599 \pm 52	COD (mg COD/g inorganic solids)	399 \pm 30
VIP 1 sample 2 MIDDLE CENTRE		VIP 1 sample 5 MIDDLE SIDE	
COD (mg COD/ g sample)	95.8 \pm 6	COD (mg COD/ g sample)	88 \pm 3
COD (mg COD/g dried solids)	475 \pm 31	COD (mg COD/g dried solids)	287 \pm 15
COD (mg COD/g inorganic solids)	824 \pm 59	COD (mg COD/g inorganic solids)	430 \pm 38
VIP 1 sample 3 BOTTOM CENTRE			
COD (mg COD/ g sample)	104 \pm 2		
COD (mg COD/g dried solids)	497 \pm 10		
COD (mg COD/g inorganic solids)	829 \pm 17		

VIP 2

- Sampling was undertaken during a period of dry weather.
- The householder admitted to adding Ushimboshi (probably Jeye's Fluid), an organic disinfectant to the pit to control smells and flies. They also claimed that some kind of muti (medicine) was added periodically at night to protect the family but it is not certain whether this was in addition to the Ushimboshi or not.
- Four samples were obtained from the pit: two at different heights below the surface were obtained from the centre of the pit directly below the pedestal hole ($r \approx 0$) and two samples from the side of the pit ($r \rightarrow r_{\max}$).
- All samples from VIP 2 had considerably less (between 12 and 38% less) moisture than from VIP 1. There was significant correlation between samples from the top of the pit (98% probability) and from lower levels in the pit (99% probability) irrespective of the radial position, with samples at the top showing substantially lower moisture content than samples further down in the pit.
- It was observed that the inorganic solids component of the solids was substantially higher (mean = 91 g inorganic solids / g dried solids %) than observed anywhere else during this project (mean = 64 g inorganic solids / g dried solids %). This may indicate that some inorganic material such as sand was added to the pit in addition to the usual pit contents. This would also explain the substantially lower moisture content observed in the pit compared to that measured in other pits.
- There was some correlation between COD values at the side of the pit, and between COD values at the side and in the lower sample taken in the centre of the pit. However, the top centre sample showed COD values significantly lower than any of the other measurements. The high inorganic solids fraction of VIP 2 pit contents result in low reported values of COD on a total solids basis. Thus there is no clear correlation between COD values measured in this VIP compared to values reported elsewhere in this report.

- A homogenous sample was collected from VIP 2 and anaerobically transferred to serum bottles for a methanogenic activity test (Table 3.9). Although relatively low amounts of CO₂ gas were produced, essentially no methane gas was produced over an incubation time of nearly one month. Mid-way through the test, the bottles were spiked with a small amount of labile substrate (sodium acetate) but still no methane production was detected. This indicates that there was an insignificant population of active methanogenic micro-organisms present in the sample, or that a non-degradable inhibitory substance was present.
- The four samples were tested for biodegradability of the COD using a serum bottle technique with an incubation time of 45 days (Table 3.9). No inhibition was observed in these experiments with all replicates producing significantly more methane than the control sets (endogenous anaerobic sludge). Values of biodegradability varied between 23% and 43% with a high relative standard deviation (in some cases greater than 100%) were obtained. Because of the large uncertainty of these values, none of the values were significantly different, although the two samples from the centre of the pit ($r \approx 0$) showed similar trends in gas production, as did the two samples from the side of the pit. (Note that unlike the methanogenic activity test, methane production from this test was possible since methanogenic micro-organisms were present in the inoculum with which the pit samples were incubated.)

Table 3.7: Study A VIP 2: Moisture content and solids analyses. Results are presented as value \pm standard deviation. n=3 for all results reported. TS: Total solids; OS: organic solids; IS: Inorganic solids

VIP 2 sample 1 TOP CENTRE		VIP 2 sample 3 TOP SIDE	
Moisture (% g moisture/g sample)	30 \pm 3	Moisture (% g moisture/g sample)	29 \pm 3
TS (% g solids/g sample)	70 \pm 3	TS (% g solids/g sample)	71 \pm 3
OS (% g OS/g dried sample S)	6 \pm 1	OS (% g OS/g dried sample S)	7 \pm 1
IS (% g IS/g dried sample)	94 \pm 1	IS (% g IS/g dried sample)	93 \pm 1
VIP 2 sample 2 BOTTOM CENTRE		VIP 2 sample 4 BOTTOM SIDE	
Moisture (% g moisture/g sample)	47 \pm 4	Moisture (% g moisture/g sample)	44 \pm 3
TS (% g solids/g sample)	53 \pm 4	TS (% g solids/g sample)	56 \pm 3
OS (% g OS/g dried sample)	15 \pm 2	OS (% g OS/g dried sample)	11 \pm 1
IS (% g IS/g dried sample)	85 \pm 2	IS (% g IS/g dried sample)	89 \pm 1

Table 3.8: Study A VIP 2: Results of COD analyses reported on wet basis, dry basis and *per mass inorganic solids* basis. Results are presented as value \pm standard deviation. n=3 for all results reported

VIP 2 sample 1 TOP CENTRE		VIP 2 sample 3 TOP SIDE	
COD (mg COD/ g sample)	50 \pm 5.09	COD (mg COD/ g sample)	111 \pm 6
COD (mg COD/g dried solids)	71 \pm 7.96	COD (mg COD/g dried solids)	156 \pm 10
COD (mg COD/g inorganic solids)	76 \pm 8.51	COD (mg COD/g inorganic solids)	168 \pm 11
VIP 2 sample 2 BOTTOM CENTRE		VIP 2 sample 4 BOTTOM SIDE	
COD (mg COD/ g sample)	77 \pm 5.40	COD (mg COD/ g sample)	61 \pm 4
COD (mg COD/g dried solids)	146 \pm 14.0	COD (mg COD/g dried solids)	110 \pm 8
COD (mg COD/g inorganic solids)	171 \pm 17.0	COD (mg COD/g inorganic solids)	124 \pm 10

VIP 3

- This VIP was sampled on a day that had been preceded by heavy rainfall and samples appeared to have high moisture content.

- The owners denied adding any chemical additives to this pit, but did add household water. They complained of smells and maggots
- Two samples were obtained from the VIP, one in the centre ($r \approx 0$) and one from the side of the pit ($r \rightarrow r_{\max}$).
- Only methanogenic activity tests were performed on samples from this VIP (Table 3.9). Four replicates were performed for each of the two samples. In contrast to VIP 2, each of the replicates was observed to produce a significant amount of methane gas. By combining measurements of the mass of the bottle contents at the beginning and the end of the experiment and the methane gas production, it was estimated that between 1 and 5% of the COD in the bottles had been converted to methane gas over a three week period at an elevated temperature (35 °C). The uncertainty on the final values of COD conversion meant that it was not possible to detect any significant difference between the methanogenic activity of the centre sample and the side sample.

VIP 4

- VIP 4 was sampled on the same day as VIP 3 and appeared to have high moisture content.
- The owners denied adding any chemical additives to this pit, but did add household water. They complained of maggots
- Two samples were obtained from the VIP, one in the centre ($r \approx 0$) and one from the side of the pit ($r \rightarrow r_{\max}$).
- Only methanogenic activity tests were performed on samples from this VIP (Table 3.9). Four replicates were performed for each of the two samples. In contrast to VIP 2, each of the replicates was observed to produce a significant amount of methane gas. By combining measurements of the mass of the bottle contents at the beginning and the end of the experiment and the methane gas production, it was estimated that between 1 and 21% of the COD in the bottles containing sample from the centre of the pit had been converted to methane gas over a three week period at an elevated temperature (35 °C), while between 1 and 2% COD conversion was observed in bottles containing sample from the side of the pit. Three out of 4 replicates for the central sample exhibited significantly higher methanogenic activity than the than the sample from the side of the pit. However, the 4th replicate from the centre sample had exhibited the lowest methanogenic activity of all the samples. Hence it is concluded that methanogenic activity is generally higher in the centre of the pit, but that this is not a uniform observation; methanogenic activity is depended on local conditions at the point of sampling.

Table 3.9: Summary of results from methanogenic activity tests and biodegradability tests on samples from 4 VIPs from Study A: Marian Ridge Township

VIP	Methanogenic activity	Biodegradability
1	Not done	Inhibitory
2	No methane production, little CO ₂ produced, apparently no methanogenic micro-organisms present	Between 23% and 43% of COD biodegradable
3	Methane produced (1 – 5% of COD converted over 21 days)	Not done
4	Methane produced (1 – 21% of COD converted over 21 days)	Not done

3.4.4.2 Summary of results obtained from study B: Tongaat

In study A, samples were obtained through the back plate or pedestal of working VIPs and therefore the samples could not be obtained from depths greater than approximately half a metre below the surface. In contrast, in study B, samples were obtained during a pit emptying exercise in which a workman entered the pit through the back plate and manually shovelled pit contents out of the pit. Samples for analysis were taken when the pit was full, half-emptied and from the bottom of the pit when virtually empty. A slight disadvantage

of this work is that a pit emptier was standing in the pit, trampling the pit contents and thus some mixing of pit contents would have occurred.

Table 3.10 presents results of moisture, solids and COD analysis on samples from the top, middle and bottom of a pit located near Tongaat. There is no apparent systematic variation in COD content, although (on a dried basis) it appears that the COD concentration is lower at the bottom of the pit than in the middle or top. However, there is a very clear variation in moisture content and in organic solids fraction. Both of these determinants decrease systematically from the top of the pit to the bottom.

Table 3.10: Moisture content, solids analyses and COD analysis for samples obtained from Tongaat VIP. Results are presented as value \pm standard deviation. n=3 for all results reported. TS: Total solids; OS: organic solids; IS: inorganic solids

Tongaat VIP Sample 1 TOP CENTRE			
Moisture (% g moisture/g sample)	80 \pm 0.07	COD (mg COD/ g sample)	150
TS (% g solids/g sample)	20 \pm 0.07	COD (mg COD/g dried solids)	738
OS (% g OS/g TS)	62 \pm 5		
IS (% g IS/g TS)	38 \pm 5		
Tongaat VIP Sample 2 MIDDLE CENTRE			
Moisture (% g moisture/g sample)	73 \pm 2	COD (mg COD/ g sample)	199
TS (% g solids/g sample)	27 \pm 2	COD (mg COD/g dried solids)	733
OS (% g OS/g TS)	53 \pm 2		
IS (% g IS/g TS)	47 \pm 2		
Tongaat VIP Sample 3 BOTTOM CENTRE			
Moisture (% g moisture/g sample)	66 \pm 4	COD (mg COD/ g sample)	172
TS (% g solids/g sample)	34 \pm 4	COD (mg COD/g dried solids)	503
OS (% g OS/g TS)	42 \pm 2		
IS (% g IS/g TS)	58 \pm 2		

3.4.5 Discussion: Processes in pit latrines

Examination of the data gathered in this project indicate that within a small sample of VIPs located in similar hydrogeological conditions and in the same community, there is a significant variation in the characteristics of pit contents between pits. Variations within a pit in terms of solids analysis, moisture content or COD concentration were observed, and a number of possible causes of these variations were identified.

3.4.5.1 Rainfall

Although there is insufficient data to fully support this observation, it appears that rainfall affects the moisture content of the pits. This is implied by the visual observation of the samples and by the fact that in the cases where measurements of moisture content were made, the pit sampled during rainy weather had a much higher moisture content than that which was sampled during dry weather, despite the fact that there was no apparent way for rainwater to enter the pit. This observation implies that subsurface water movement dependent on rainfall may have a significant effect on the characteristics of pit contents.

3.4.5.2 Moisture content

The moisture content of the pits varied significantly from about 30% to about 80%. Moisture content as low as 30% was not commonly observed in this study (Section 0). However, such a low value was attributed to the very steep and sandy locality of the pit latrines used in this part of the study, and the very dry weather that had preceded the sampling day for VIP2 in the Marian Ridge study.

3.4.5.3 *Methanogenic activity*

The methanogenic activity ranged from no activity observed in samples from VIP 3 to significant methane formation from VIP 4.

3.4.5.4 *Variations within a pit: Study A, Marian Ridge*

In Study A, there were few clear trends observed in moisture, organic content and COD content with different locations within the pit. This may be attributed to two flaws in the sampling and analysis programme; firstly, the pits could only be sampled to a depth of approximately 300 mm below the surface of the pit contents, and this distance may not have been sufficient to observe systematic variations in pit content characteristics; and secondly, the samples were analysed as pseudo-replicates with a limited number of replicates, and therefore not much certainty may be placed on the representivity of the results presented in Table 3.5 to Table 3.8 above. However, some trends may be tentatively identified:

- From VIP 1, moisture content is likely to be lower below the surface and to the side of the pit than on the surface or in the centre of the pit, indicating that water drains away through the pit walls, rather than through downward percolation through pit contents.
- From VIP 2, in extremely dry conditions, moisture loss by evaporation off the surface of the pit will occur at a faster rate than moisture content through drainage through pit walls, resulting in lower moisture content at the surface than below the surface.
- It is not possible to identify any overall significant trends in organic content or amount of COD in samples from different locations from this data.

The sample size for the specific methanogenic activity test (only two pits exhibited significant methanogenic activity) was too small to make any generalised statements about the distribution of methanogenic activity. However, the observation of some methanogenic activity in VIP 3 and 4 confirmed that complete anaerobic digestion (i.e. reduction of organic material to methane gas) does occur to some extent in the contents of some pit latrines under non-inhibiting conditions.

Finally, the results of this study indicate that all positions within the pit contain some biodegradable COD.

Study A used material from four different VIPs located in the same soil type on a steep hill. The material in the pits was observed to be considerably drier than seen in many other latrines visited in this project. Therefore the specific conclusions made in this study may not apply universally to all VIPs.

3.4.5.5 *Variations within a pit: Study B, Tongaat*

In study B, samples were obtained from significantly different depths of the pit, and should have given a reasonable representation of differences between areas of the accumulated pit contents of significantly different age. Once again, pseudo-replication of analyses will have undermined the representivity of the results presented. However, certain clear trends can be identified in this data.

Firstly, moisture content decreases significantly from the top of the pit contents to the bottom. This supports the hypothesis that in a pit where the prevailing direction of moisture movement is towards the walls and out of the pit into the surrounding soil, that moisture content will decrease as the age of the pit contents increases. This implies that there is some significant resistance to moisture loss in the pit contents that prevents all potential moisture loss from occurring on the surface of the pits. This supports the hypothesis that in deeply buried pit contents, moisture loss is caused through the lysis of dead cell matter, resulting in the release of the contents of the cells (which is mostly liquid), which is then able to drain away.

Secondly, both COD content and organic solids fraction reduce with increase in pit depth. Although these measurements are not a direct substitute for biodegradable content (which was not measured in this study), they give an indication of changes that have occurred in potentially biodegradable organic material. The

results from Study B indicate that biological activity has resulted in destruction of some organic material over time. However, these results are best interpreted in conjunction with data from fresh faeces, which indicate that the maximum COD value measured at the top of this VIP in Tongaat was approximately half that measured in fresh faeces. Similarly organic solids fractions were lower than those measured in fresh faeces.

These results support the hypothesis that significant aerobic biological activity occurs on the top surface of the pit, before the “fresh” layer is thick enough to be reliably sampled. Once covered over by new pit material, anaerobic degradation occurs at a far slower rate resulting in gradual reduction of organic material. If the starting concentration of COD is taken as the average COD content of faeces presented in Table 3.2 of 1 448 mg COD/g dried solids, then the top sample from Study B indicates that an overall COD reduction of 49% has occurred already, or considering only the biodegradable COD fraction, of 61%. Similarly, samples from the bottle represent a total COD reduction of 61% or a biodegradable COD reduction of 82%. Although these numbers are only an approximation of the amount of degradation that may have occurred (since neither the true fresh faeces COD content nor the biodegradable fraction of the material added to this pit are known) these numbers support the general hypothesis that has been developed and presented in Section 3.1.

3.4.6 Conclusions and recommendations: Processes in pit latrines

The biological processes occurring in a VIP are dependant on the actions of the users and on the moisture content of the pit. A number of conclusions and recommendations have arisen out of these studies and are reported hereafter.

The following conclusions can be made:

- There is a large variation in the physical and chemical composition both within a pit and from pit to pit.
- There appears to be a net decrease in moisture, COD content and organic solids fraction for increase in the depth of pit contents
- Anaerobic micro-organisms are present and active in most of the samples, but methanogens were not active in all samples.
- The addition of biocidal compounds by pit users can have a detrimental effect on the biological activity in the pit.
- Results from Study B (Tonga) support the general theory of processes in pit latrines outlined in Section 3.1.

It is recommended that the analyses performed for Study B are repeated for a statistically significant number of VIPs during a pit emptying campaign¹, and that care is taken to avoid pseudo-replication in repeat analyses on the same sample.

3.5 Effect of additional moisture and alkalinity on anaerobic digestion of pit latrine contents

Early results in this project indicated that anaerobic digestion rates in the buried contents of pit latrines were low. The low rates of anaerobic digestion could have been as a result of either low inherent biodegradability and recalcitrant nature of the residual organic material in the pit latrine, or due to the presence of factors (such as low moisture content or pH buffering capacity) that limited the rate of anaerobic digestion. It was hypothesised that the rate of anaerobic digestion, and therefore the rate of conversion of solid organic material to gaseous or liquid-soluble products could be facilitated through removal of factors that limit the

¹ These analyses are being performed as part of WRC project K5/1745 After the pit is full then what? Strategies to manage on-site dry sanitation systems into the future

rate of anaerobic digestion. The null hypothesis in this case was that the low rates of anaerobic digestion observed were due to low inherent biodegradability of the organic material in the pit latrine contents.

3.5.1 Preliminary investigation into rate-limiting factors in anaerobic digestion

A preliminary study on factors affecting anaerobic digestion of faeces was undertaken using a modification of the serum bottle method for assessment of inhibition (Owen et al., 1978). This study was undertaken as part of a BSc. Hons. Study Naidoo (2005).

3.5.1.1 Materials and methods

15 g samples of faeces were incubated alone, with anaerobic sludge, and with anaerobic sludge and five different alkaline solutions of varying concentration. Gas production rates were compared to the gas production rate of anaerobic sludge alone. All test units were prepared in triplicate in 125 ml serum bottles and sealed with a butyl rubber septum and aluminium crimp cap. Anaerobic sludge was used as an inoculum. It was obtained from a digester at Umbilo WWTP and stored in a closed container until a constant low rate of activity was achieved. Table 3.11 presents the composition of each test unit.

Table 3.11: Composition of test units testing biogas production from digestion of faeces with and without additional micro-organisms and alkalinity. All test units were prepared in triplicate

Treatment number	Faeces [g]	Inoculum [ml]	Alkaline solution [l] x [mg/l Na ₂ CO ₃]
1	15	10	0.02 x 500
2	15	10	0.02 x 400
3	15	10	0.02 x 300
4	15	10	0.02 x 200
5	15	10	0.02 x 100
6	15	10	-
7	15	-	-

3.5.1.2 Results

Gas production from the different treatments is presented in Figure 3.5. Data from each treatment are presented as an average of three replicates. Confidence intervals for all units were large due to the difficulty of obtaining representative and accurately sized samples of faecal material.

Initial gas production for approximately 10 days was high; during this period bacteria were consuming substrate and growing. However from day 10 to 20, a significant decrease in the rate of gas production was observed. The drop in gas production rate was indicative of some form of inhibition, such as accumulation of organic acids, low pH, or accumulation of dissolved H₂, which all result in reduced anaerobic activity. Low gas production was observed until the end of the experimental period for treatments 6 and 7 (no additional alkalinity), implying that inhibition of gas production, and particularly methane production remained throughout the experiment in these units. Treatments 1 to 5 i.e. those that contained additional alkalinity recovered after day 20 to achieve a gas production rate similar to, and in some cases in excess of that in the period before day 10, indicating that micro-organisms had overcome inhibitory conditions after initial inhibition.

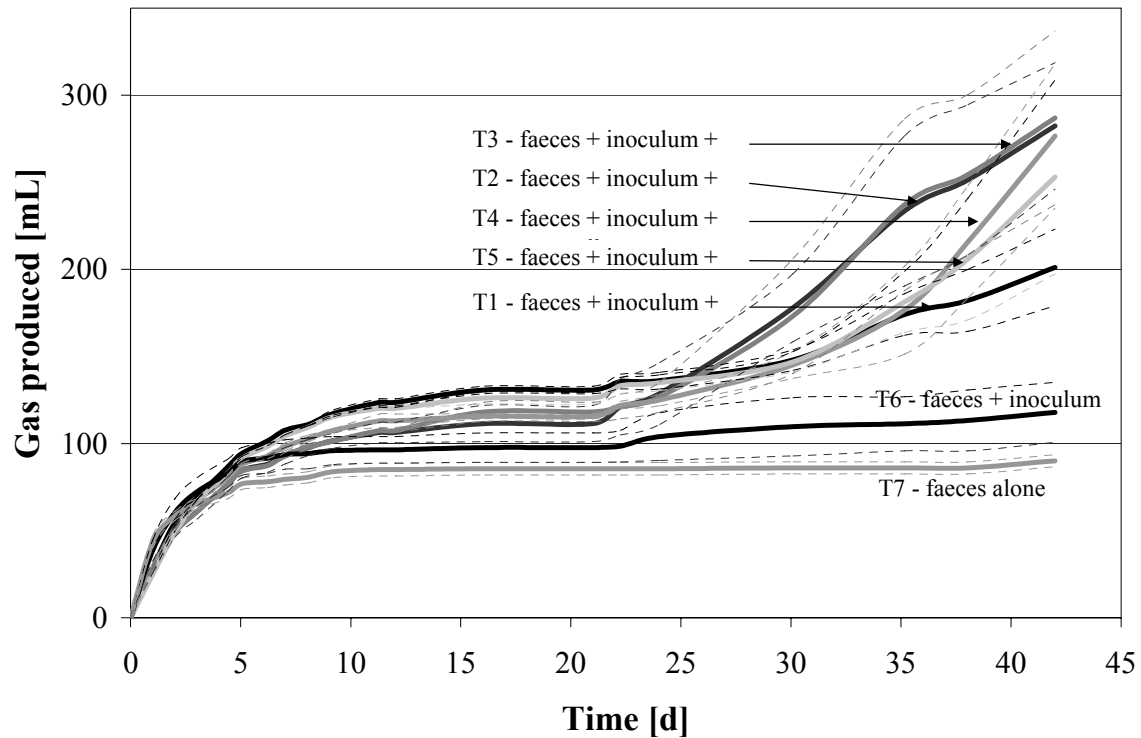

Figure 3.5: Gas production from faeces incubated alone, with anaerobic sludge and with both anaerobic sludge and additional alkalinity. Solid lines indicate the mean of 3 replicates. Dashed lines indicate the range of the standard error of the mean.

There was no significant difference in cumulative gas production after 42 days between units with different concentrations of added alkalinity (student's t-test, $p > 0.05$). However the difference between cumulative gas production in any sample with added alkalinity (treatments 1 to 5), and treatment 6 which contained no additional alkalinity was significant ($p < 0.05$). There was no significant difference between treatment 6 (no additional alkalinity) and treatment 7 (no additional alkalinity or sludge) ($p > 0.05$).

3.5.1.3 Conclusions

These results give rise to two important conclusions:

- Since the gas production from treatments 6 and 7 (faeces and inoculum vs. faeces only) are not significantly different, it suggests that there is a large micro-organism population present in the faeces at source; therefore there is an inherent ability for faeces to be naturally broken down. However, as both of these treatments indicate inhibition, the relative concentrations of micro-organisms cannot be inferred.
- The addition of an alkaline solution to the test units allowed recovery of gas production after a period of inhibition. The units that were not incubated with additional alkalinity did not exhibit a similar recovery within the experimental period. This implies that digestion of faecal matter generates higher acid production rates than can be converted to biogas, or absorbed by available buffering capacity and that addition of alkalinity may have a significant effect on the rate of stabilisation of organic material in a pit latrine. As no reference unit was used in which only water was added, it is not possible to infer whether the recovery in gas production was due to additional moisture in test units 1 to 5, or to additional buffering capacity due to addition of Na_2CO_3 .

While these conclusions provide support for the general theory of processes in pit latrines presented in Section 3.1, specifically, that a significant micro-organism population capable of degrading faeces is presenting in the faeces themselves, it should be noted that, according to the general theory, fresh faeces

are not subjected to anaerobic conditions. Therefore, biogas production patterns from fresh faeces are not particularly relevant to conversion processes in the accumulated contents of a pit latrine.

3.5.2 Effect of alkalinity and moisture content on anaerobic digestion in a pit latrine

This section presents a summary of the work performed for an MSc Eng Thesis submitted for examination at Université Paul Cézanne, France in June 2007 (Couderc, 2007). The work is presented in more detail in Appendix B. This study aimed to measure the effect of additional moisture and/or alkalinity on the rate of anaerobic digestion in samples of material obtained from the top layer of a pit latrine.

The experiment was designed to test the combination of moisture and alkalinity (the factors) on the rate of biogas production at different concentrations of each of the factors. The experimental plan was constructed as a factorial matrix with two factors (moisture and alkalinity) and six levels (concentrations of moisture or amounts of added alkalinity). In the matrix, one axis represented moisture added with volumes from 0 to 25 ml additional moisture (i.e. overall moisture content between 76% and 91% and the other axis represented added alkalinity from 0 to 2.5 mg NaHCO₃/bottle (Table 3.12). Each cell in the matrix represented one experiment with a specific amount of added water and/or alkalinity. Thus, 6² = 36 experiments were required and each of the 36 experiments was conducted in triplicate.

Two sets of experiments were undertaken, as well as a number of supporting experiments. These are outlined in Appendix B.

3.5.2.1 Summary of Results

The first set of experiments were undertaken using raw material (VIP contents) sampled from a household VIP near Tongaat, north of Durban, during a pit emptying campaign. The material collected came from the lower part of one pit. The pits were around fifteen years old thus the material used was fairly well degraded and stabilised. Generally poor gas production rates were observed from all experiments in this set (Figure 3.6). Statistical interrogation of the data showed that there was no significant difference between any of the treatments and the controls. Two-factor analysis showed that there was no statistical basis to support the hypothesis that added alkalinity or added moisture improved gas production rates. However, it appeared that the addition of moisture had a negative effect on the rate of gas production.

It was hypothesised that the generally poor gas production data were due to the nature of the material used for the experiments: low residual biodegradability of the material would have resulted in low gas production rates. To test whether this was the case, and thereby to overcome the problem of low gas production rates, the experiments were repeated using fresher material. The new sample was collected from a rural school outside Pietermaritzburg. This new material came from the top layer of a pit and thus was presumably not as well degraded as the previous sample. All the experiments for Set 2 were prepared at the same time and the sample was mixed (as well as it is possible to do so) before filling of the bottles.

Figure 3.7 presents cumulative gas production after 36 days in matrix form to show the effect of increasing moisture and alkalinity on gas production. Note that the scale on the vertical axis of Table 3.7 is much larger than that of Table 3.6 due to the much higher gas production rates. Figure 3.7 shows that the control bottles (i.e. no moisture or alkalinity added) produced virtually no gas. In contrast, all other experimental bottles produced significant amounts of gas. Clearly, according to these results, the addition of water had a significant effect on the gas production rate.

The data from Set 2 did not support the hypothesis that the addition of alkalinity had any effect on the gas production rate (either positive or negative). However, regression analysis showed that there was a significant relationship between the rate of gas production and the moisture content¹. However, only 10% of

¹ Significance of regression = 0.002 < 0.05 therefore it is a 95% probability that increased moisture content causes an increase in gas production

the variation observed in the data can be explained by the moisture content ($R^2 = 0.097$); i.e. 90% was due to unmeasured factors such as the variation in biodegradability of the pit latrine contents due to its non-homogeneous nature. The regression predicted that the rate of gas production increased by a rate of between 0.006 and 0.02 ml gas/g total solids/day per 1% increase in moisture content.

Table 3.12: Summary of experimental plan (factorial matrix) to assess the effect of additional moisture and alkalinity on the anaerobic digestion of VIP contents. Each cell represents one experiment performed in triplicate containing substrate (15 g VIP solids) and varying amounts of additional water and alkalinity. Mass of alkalinity per bottle is concentration of the stock solution used (S_i ; $i \in [1,5]$) X the volume added. S_1 : 100 mg/l, S_2 : 200 mg/l, S_3 : 300 mg/l, S_4 : 400 mg/l, S_5 : 500 mg/l of NaHCO_3 . T_j is the treatment label ($j \in [1,36]$). Moisture content values presented were those calculated for Trial 2.

		% moisture (g H ₂ O/ g sample)					
		76	82	86	88	90	91
Amount of alkalinity added (mg NaHCO ₃ / g dried solid)	0	76% H ₂ O 0 ml S ₁ (T ₁)	82% H ₂ O 5 ml S ₁ (T ₂)	86% H ₂ O 5 ml S ₁ (T ₃)	88% H ₂ O 5 ml S ₁ (T ₄)	90% H ₂ O 5 ml S ₁ (T ₅)	91% H ₂ O 5 ml S ₁ (T ₆)
	1.8		82% H ₂ O 5 ml S ₂ (T ₈)	86% H ₂ O 5 ml S ₂ (T ₉)	88% H ₂ O 5 ml S ₂ (T ₁₀)	90% H ₂ O 5 ml S ₂ (T ₁₁)	91% H ₂ O 5 ml S ₂ (T ₁₂)
	3.6		82% H ₂ O 5 ml S ₃ (T ₁₄)	86% H ₂ O 5 ml S ₃ (T ₁₅)	88% H ₂ O 5 ml S ₃ (T ₁₆)	90% H ₂ O 5 ml S ₃ (T ₁₇)	91% H ₂ O 5 ml S ₃ (T ₁₈)
	5.4		82% H ₂ O 5 ml S ₄ (T ₂₀)	86% H ₂ O 5 ml S ₄ (T ₂₁)	88% H ₂ O 5 ml S ₄ (T ₂₂)	90% H ₂ O 5 ml S ₄ (T ₂₃)	91% H ₂ O 5 ml S ₄ (T ₂₄)
	7.2		82% H ₂ O 5 ml S ₅ (T ₂₆)	86% H ₂ O 5 ml S ₅ (T ₂₇)	88% H ₂ O 5 ml S ₅ (T ₂₈)	90% H ₂ O 5 ml S ₅ (T ₂₉)	91% H ₂ O 5 ml S ₅ (T ₃₀)
	9.0		82% H ₂ O 5 ml S ₆ (T ₃₂)	86% H ₂ O 5 ml S ₆ (T ₃₃)	88% H ₂ O 5 ml S ₆ (T ₃₄)	90% H ₂ O 5 ml S ₆ (T ₃₅)	91% H ₂ O 5 ml S ₆ (T ₃₆)

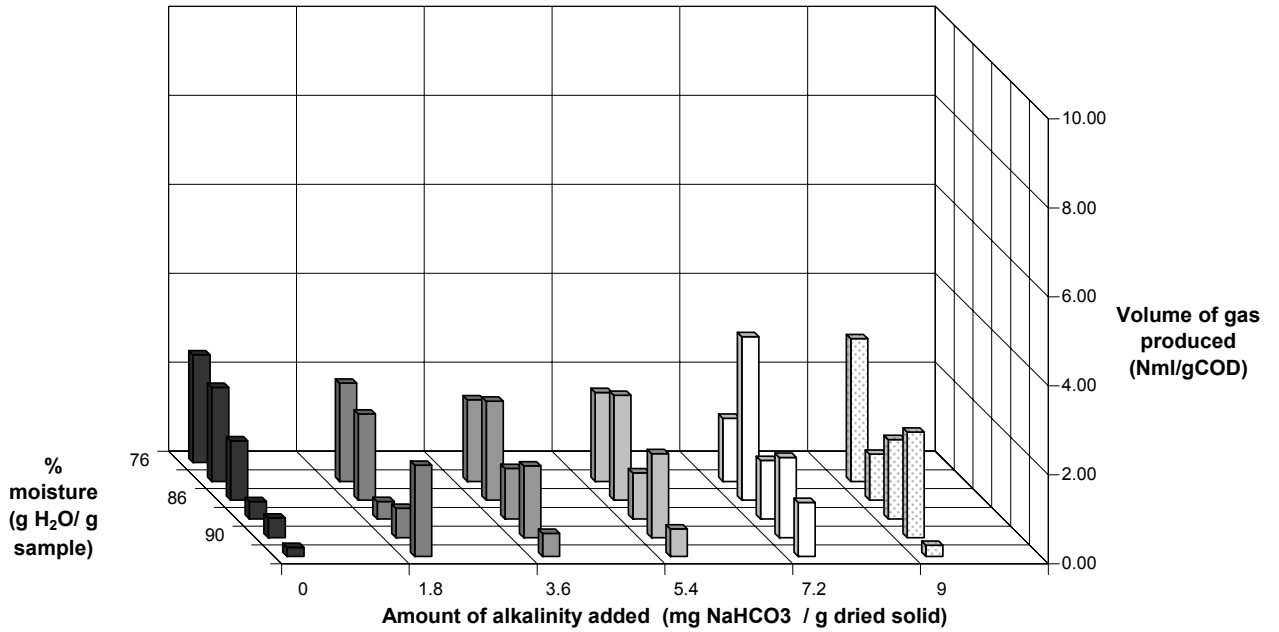

Figure 3.6: Combined results of cumulative gas production after 40 days from Set 1 experiments

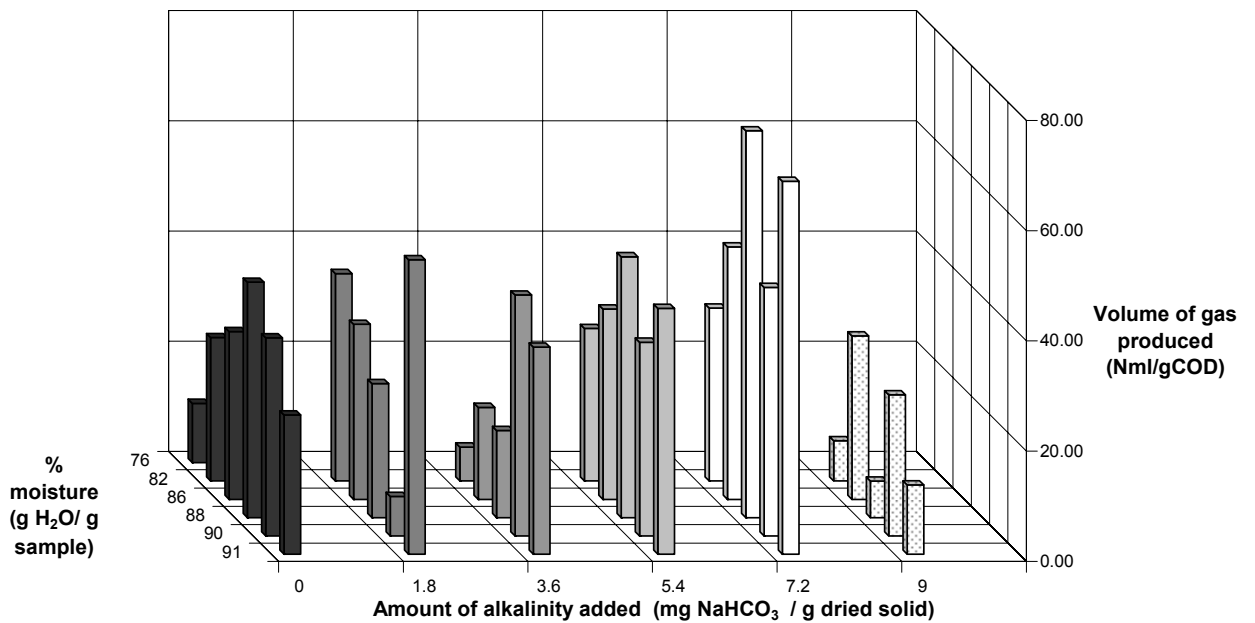

Figure 3.7: Cumulative gas production results after 36 days for experiment Set 2 showing dependence of gas production on additional moisture and alkalinity.

3.5.2.2 Conclusions from Set 1 and Set 2 experiments

The purpose of these experiments was to determine whether addition of moisture and/or NaHCO₃ to samples of fresh VIP contents had a statistically significant effect on gas production rate under anaerobic

conditions. The gas production rate was understood to be correlated to the rate of anaerobic degradation of the VIP contents, and an enhanced gas production rate would thus be an indication of improved stabilisation rates. Experiments from Set 2 showed that VIP contents alone (with no additional water or NaHCO₃) had negligible gas production across three replicates; however, addition of water only or water and NaHCO₃ resulted in statistically significant increases in gas production. It was not possible to determine whether the addition of NaHCO₃ had any effect on gas production rate (either positive or negative)

It was also observed that increasing the amount of water at the beginning of the experiment could have the opposite effect, i.e. reduced gas production rates as a result of absorption of CO₂ in the moisture (See Appendix B for details). However, after a certain amount of time, CO₂ absorption ceased as the inorganic carbon content in the aqueous phase approached saturation with respect to the headspace of the experiment.¹ Thereafter, the gas production rate (as opposed to the cumulative amount of gas produced) was greater for experiments with more added water than those with less.

The conclusion of this work was that increasing moisture content of VIP contents has the potential to increase the rate of stabilisation of buried organic material in the pit.

Significantly greater amounts of gas were produced per test unit for Set 2 units relative to Set 1 units. This supports the hypothesis that the generally poor performance of all treatments in Set 1 was less a function of the treatments than that the VIP contents used were already well digested and therefore inherently resistant to further degradation.

This study supports the motivating hypothesis that the moisture content generally observed in VIP material is low and may be a limiting factor in the rate of anaerobic digestion that may occur in the buried pit contents. This implies that increasing the moisture content in the pit has the potential to increase stabilisation rates in the pit. These broad findings are supported by literature which state that the rate of accumulation in pits is lower in *wet* pits than in *dry* pits (Franceys et al., 1992).

This study indicated that addition of NaHCO₃ resulted in no significant effect on gas production rate, thereby refuting the hypothesis that there is insufficient buffering capacity in pit latrine contents to support stable anaerobic digestion. This could be explained in the context of the general theory of processes in pit latrines (Section 3.1) in that if a significant proportion of the biological conversion of organic material in the pit latrine happens aerobically on the surface of the pit three effects would reduce the pH buffering requirement in pit latrine contents:

- The buffering capacity requirement for aerobic degradation is less than for anaerobic digestion since there is no accumulation of acid intermediates in aerobic degradation.
- There will be a smaller load of organic material requiring anaerobic digestion, and thus a smaller overall buffering requirement (than if the entire load of organic material entering the pit were considered)
- The process of aerobic degradation will increase the overall alkalinity of the contents of the pit latrines

Finally, it may also be concluded that there is no significant benefit to adding water or alkalinity to pits wherein the material is already well-stabilised.

¹ This is a somewhat simplistic explanation since the "equilibrium" in each experiment will be dynamic: it will depend on pH, headspace gas composition and pressure, relative rate of production of CO₂ and CH₄, frequency of headspace venting and aqueous phase concentrations of a range of chemical species.

4 INVESTIGATIONS INTO COMMERCIAL PIT LATRINE ADDITIVES

A well designed and operated VIP has reduced fly and odour problems and therefore improved health benefits compared to rudimentary pits (Franceys et al., 1992; Cotton et al., 1995; Bester and Austin, 2000), but poor degradation in most pits results in a build-up of noxious and potentially hazardous material that must ultimately be removed at significant cost to either the householder or local authority or both (Still, 2002).

In a rural setting pits are generally allowed to fill to within a certain proximity to the top of the pit (e.g. 300 mm) and then covered over, a new pit is dug nearby, and the superstructure moved or rebuilt. A period of stabilisation may be allowed before pit contents are removed and the pit reused. In a peri-urban densely populated setting, full pits are either emptied by pumping out the contents (or in the case of solid contents, digging out) since alternative sanitation facilities or sites for a new pit are not usually available (Cotton et al., 1995; Still, 2002). Clearly, extending the life of the pit by reducing the rate of accumulation of material in the pit could result in substantial savings in pit maintenance.

There are a number of proprietary products available that are marketed for their ability to reduce pit contents, odour or fly problems. Independent scientific evidence of their efficacy is scarce, although there is a vast body of anecdotal evidence that suggests that they have the ability to significantly reduce pit contents, fly and odour problems. Equally, a number of informal studies have suggested that there is no significant benefit to the use of these additives over the addition of water or some essentially inert additive (in effect, a placebo). In many instances, municipalities and other service providers are hesitant to sanction the use of pit latrine additives as they have no scientific basis for choosing one product over another, and are concerned that trials with these products may lead to an expectation among communities that the products will be used forthwith. This in turn could lead to a situation where political pressure results in the application of expensive products that may or may not have any significant benefit. It is generally felt that a scientific explanation of the mechanism of pit latrine additives, and proof of their efficacy would provide the authorities with the ability to rationally assess the cost-effectiveness of implementing programmes for treating pits with additives.

4.1 Literature review into the effect of additives on pit latrine contents

Little scientific work on the efficacy of pit latrine additives has been found in the literature, although some scientific studies have been undertaken for septic tanks. It is assumed that the agents used in pit latrine additives are similar to those used for bioremediation and in septic tank additives.

4.1.1 Septic tank additives

There are three categories of septic tank additives (USEPA, 2002):

1. Inorganic compounds including strong acids or alkalis that are used for unblocking clogged drains. These products are likely to disrupt biological activity, and are unlikely to be promoted as effective pit latrine additives.
2. Organic solvents, often chlorinated hydrocarbons (e.g., methylene chloride, trichloroethylene) are often used to break down oils and grease. However, these are generally regarded to represent significant risks to both ground water and to biological treatment processes, as they are toxic in even relatively small doses to most micro-organisms.
3. Biological additives, like bacteria and extracellular enzymes mixed with surfactants or nutrient solutions. In septic tank systems, these are described as mimicking normal biological decomposition processes in the septic tank, without significantly enhancing them, except under extremely stressed

conditions. Some additives in this category have been shown to degrade or dissipate septic tank scum and sludge, but simultaneously add to increased loadings of BOD, TSS and other contaminants in the septic tank effluent.

The effect of any of the above additives on pit latrines may be different to septic tanks as, although the fundamental biochemistry of the two processes is similar, the conditions are very different. Septic tanks carry a higher hydraulic load as influent is not limited to toilet contents, and therefore are more dilute. The volume based organic load is also lower in septic tanks than in pit latrines and therefore the overall stability of the anaerobic digestion is better. Secondly, septic tanks are flow-through systems and therefore, soluble toxicants or acids have a limited retention time in the system before being carried out. In a pit latrine, toxic components and acid will remain in the pit considerably longer as a result of the slower transport within the pit and from the pit to the surrounding soil. Thus components that may adversely affect the processes in the pit would generally have a longer residence time in the pit and therefore exert an inhibitory or toxic effect for a longer time than they would in a septic tank.

Therefore, although no authorities were found that recommend the use of additives in septic tank systems this does not necessarily mean that similar products would not be beneficial in a pit latrine. There is clearly a need for an unbiased and scientific study to identify and quantify what effects if any are achieved by the use of these products.

4.1.2 Studies into the efficacy of pit latrine additives

It is significant that there does not appear to be any mention of pit latrine additives in the published pit latrine literature supplied by World Health Organisation, University of Leeds or Water, Engineering and Development Centre (WEDC, Loughborough University). A wealth of experience relating to every other aspect of pit latrine management is presented, but the use of additives for assisting in pit maintenance is not described at all. In contrast additive manufacturers publish web pages which describe in greater or lesser detail the mechanisms by which additives containing micro-organisms assist in degrading material in pits, thereby reducing pit contents volume, odours and flies.

This literature review only discovered two scientific studies into the efficacy of pit latrine additives. The first was a WRC project (Taljaard et al., 2003) evaluating the ability of microbial or microbially-derived products to treat pit latrine contents. This study had two experimental parts: firstly, samples of faeces were incubated under aerobic conditions at 22°C in a fully-automated Micro-Oxymax respirometer, which is equipped with CO₂, O₂ and CH₄ sensors in the headspace of each respirometer bottle. In order to maintain oxygen consumption and CO₂ production rates within the range of operation of the respirometer, and to ensure even distribution of the bio-supplements to be tested over the surface of the faeces, a volume ratio of approximately 2:5 faeces to bio-supplement solution was used. This is several *orders of magnitude* greater than the volume ratios that would be used in the field. Twelve different pit latrine additives were tested. The faeces were combined with sterilised water to make a paste and added in a thin layer on the bottom of each respirometer flask. To the paste was added the calculated dosage of bio-supplement and a small amount of a nutrient solution. Samples were agitated through-out the 5 day experiment. The conditions created in the respirometer were therefore ideal for micro-biological degradation of the faecal material: a high ratio of micro-organism originating from the bio-supplement to food was supplied; no inhibiting effects that might be caused by presence of urine in a pit were experienced, an unlimited oxygen supply with little mass transfer resistance was provided and agitation ensured that good contact between bio-supplement and faeces was obtained. Under these conditions, COD removal (calculated from average sample concentrations measured before and after incubation) in control vessels containing only faeces paste and nutrients were recorded to fall between 7 and 20% of COD added, while vessels containing faeces and bio-supplement displayed COD removal efficiencies between 12 and 74% faeces and bio-supplement for the different bio-supplements over the 5 day experiments. Total suspended solids (TSS) removal for the controls ranged from 16 to 28% and from 6 to 71% over 5 days in the experiments treated with bio-supplement. Bio-supplements that caused significant COD reduction usually also resulted in significant TSS reduction. These results indicate that

certain of the bio-supplements at the dosages applied are able to significantly increase COD and TSS removal rates over those which occur naturally. However the dosages used in these experiments were far beyond those that could be used in practice.

The second part of the experimental study involved using two of the bio-supplement products that had been shown to be effective in removing COD and TSS in the first part of the experiment to treat real pit latrine contents. The site of this part of the study was labourers' toilet blocks at a rose farm in Magaliesburg. Three blocks each containing 3 pits were isolated for the study. Two of the blocks were treated with each of the two bio-supplement products and watered on a daily basis to simulate urine addition. The third block was treated with the same amount of water as the other two blocks, but no bio-supplement was added. Researchers tried to prevent the labourers from using any of these pits during the course of the study. The pits were open (did not have pedestals or squat hole covers) and did not have vent pipes. Researchers removed sections of the corrugated roof to discourage people from using the pits. Some reduction in pit contents was seen in the two blocks where the toilets were treated with bio-supplement, and none was recorded for the control blocks, however, the volume reduction was very little (a maximum of 22 cm over a period of 3 months when no additional solid material was being added). It was noted that there was some improvement in fly and smell problems in the pits treated with bio-supplements, but no improvement was noted in the control pits.

The authors of this study cautiously suggested that bio-supplements are able to reduce pit contents, but that conditions in the field study were not optimal for achieving good solids reduction due to low temperatures, and the presence of non-degradable objects in the vaults (Taljaard et al., 2003).

The second pit latrine additive study was reported at a Water, Engineering and Development Centre (WEDC) conference in 1998 (Jere et al., 1998). In this study, a pit latrine additive, termed a *bio-organic breakdown compound* consisting of spore-forming non-pathogenic bacteria was dosed to 4 pit latrines weekly for four weeks. The compound was added to pits by injection through a perforated tube under pressure to achieve mixing of the additive with the pit contents. This study showed that the treatment had a significant effect on height of pit contents. Unfortunately, there was no control against which the results could be compared. Decrease in pit height continued for 8 weeks after dosing was suspended indicating that the treatment may have achieved long-term improvement in digestion rates in the pit. Chemical analysis data were presented and showed a decrease in COD, BOD and Kjeldahl nitrogen concentrations, although it was not clear how these values should be interpreted in terms of the load of COD, BOD and TKN load in the pit contents. The authors cautiously concluded that the additives showed promise for reducing filling rates. However, the results do not indicate the contribution to the decrease in pit contents height of the method of application (injection under pressure through a perforated tube into the pit contents).

Although some work has been undertaken to test the efficacy of commercial pit latrine additives on controlling filling rates, the work reported does not provide sufficient evidence to prove that additives containing micro-organisms significantly increase the rate of degradation of pit latrine contents; however, micro-organisms from pit latrine additives are clearly able to digest pit latrine contents.

4.2 Inventory of pit latrine additives

This section gives details of a number of pit latrine additives and their suppliers which have been to date identified as being marketed in South Africa. This list is not exhaustive, but consists of those products that were obtained and used in this study.

Most products are supplied with a Material Safety and Data Sheet (MSDS). From these and supporting documentation supplied with the products or obtained from open source literature, most of the additives consist largely of freeze-dried bacteria. Most seem to favour aerobic bacteria, though one claims to be effective under both aerobic and anaerobic conditions. None of the micro-organisms are genetically modified, but are cultures of naturally occurring micro-organisms that have been selected on the basis of

their ability to metabolise mixed organic material. Certain of the products are also understood to have been blended with isolated enzymes to facilitate hydrolytic processes. Table 4.1 provides a list of certain of the products that were commercially available during the course of this project, including manufacturers' descriptions of their alleged action in pit latrine contents.

Table 4.1: List of manufacturers' description of product actions for all commercial pit latrine additives used in this project.

Product	Manufacturer's description of product action
A	No description – product obtained directly from international manufacturer of microbial and enzyme products
B	This product contains microbes which rapidly breakdown the sewage to harmless compost products. During this process the microbes grow rapidly and multiply, increasing the efficiency of sewage breakdown. It operates by aerobic oxidation of the sewage. It requires to be in contact with the sewage and must be kept wet, for best performance. Since the microbes are aerobic, air is also required for the microbes to multiply rapidly and degrade the sewage, thus the product works in the aerobic zone near the surface of the pit
C	A blend of freeze dried bacteria and enzymes for the maintenance of pit toilets; based on natural organic extracts; can be safely used in septic tanks and pit latrines. Bacteria : Nitrosomonas sp, Nitrobacter sp, Aerobacter sp, Bacillus subtilis, Cellulomonas sp. Enzymes: Protease, Amylase, Hemicellulase, Lactase, Lipase
D ₁ & D ₂	Serve as a natural biological treatment for pit latrines and are designed for the efficient digesting of organic matter in sewage systems and VIP toilets. They are made from a live blend of class 1 bacteria, which have been specifically chosen for their accelerated ability to metabolise waste substances to carbon dioxide and water. The two products are essentially the same, except that D ₁ is granular and D ₂ is liquid.
E	A freeze-dried blend of 5 bacillus species.
F	Consists of non-pathogenic, spore-forming bacteria, pH buffer, emulsifiers, which when activated, digest organic matter. There are a minimum number of 10 billion bacteria per gram of product, which enhances the decomposition process, eliminates smells and reduces flies in the pit latrine within a week.
G	Composed of nutrients, enzymes and specific microorganisms selected for their ability to efficiently degrade organic waste. Rapid action by microbes helps to reduce foul odours and prevents flies from feeding and laying eggs in the pit contents.
H	Naturally occurring microbes, nutrients and conditioning agents.
I	A blend of 7 distinct bacteria, aimed at a general variety of sewerage problems ranging from pit toilets to oxidation and maturation ponds, including septic tanks, french drains, sewerage spills in rivers and dams, hydraulic overloading control and contamination of groundwater.
J	A blend of natural bacteria that secrete a high content of Lipase enzyme to biodegrade fats, oils and grease emanating from kitchens and food processing industry and normally works in conjunction with Product E.
K	This product is a natural bioremediation product that restores contaminated soils, controls odours, degrades volatile organic compounds (VOC's), activates anaerobic sludge digesters and activates sludge processes. It consists of naturally occurring micro-organisms attached to organic compost. When a biologically dysfunctional system is dosed with Bio-Activator the indigenous anaerobic bacteria (bacteria that do not need air or light) are rapidly stimulated to quickly degrade the waste. In the process of activation (when it is mixed with fresh water) effector molecules are generated which then stimulate the indigenous bacteria. Once stimulated, the indigenous bacteria then proceed with the task of degrading the biological waste at an accelerated rate

4.3 Field trial to test the efficacy of pit latrine additives

A small field trial was undertaken using a single pit latrine additive to develop a methodology for field trials and to identify factors that need to be addressed in a large-scale field trial. This work was sub-contracted to Partners in Development (Pty) Ltd.

4.3.1 Aims

The aims of this study were primarily methodological:

- To locate and describe a reasonably representative sample of pit latrines

- To test samples of a commercially available pit additive and corresponding placebos by recording their effect over a period of two weeks
- To familiarise the researchers, through first hand experience, with various factors important to an understanding of filling rates and pit latrine sanitation management in general
- To enable the researchers to plan relevant and effective future studies aimed at investigating pit latrine sanitation problems and challenges

4.3.2 Methodology

The study was conducted in Mpumzuza, a peri-urban but rural area northwest of Pietermaritzburg. A total of 9 pits were monitored. Four latrines belonging to private residences and four scholars' pit latrines at a primary school were visited, described and tested. One of the privately owned facilities comprised a double latrine with two separate pits and pedestals, both currently in use. The four school latrines were selected from a total of 19 latrines.

The nine pits were visited between 9 and 11 am on three occasions, one week apart, on 27/2/07, 6/3/07 and 13/3/07. During the initial visit, owners, users or occupants were questioned to establish the age of the latrine, number of users, on-site alternatives and any intermittent or routine management practices (adding of Jeye's fluid, dip, ash, or other).

The latrine design and the appearance of the structure and the contents of the pit were described and recorded. The contents of the pit viewed through the seat and the external structure were photographed. The coordinates of each site were recorded using a hand held Garmin GPS.

Using a graduated, weighted string, the distance from the underside of seat to the highest point of the heap was measured at each visit while the height of the pedestal (from the underside of seat to the underside of slab) was recorded at the first visit. In addition the height of the heap in relation to the lowest point in the pit (at the back wall) was estimated by eye

Table 4.2: Random allocation of additives and placebos in study pits, weeks 1 to 3

Pit Latrine	Week 1 (27/2/07)	Week 2 (6/3/07)	Week 3 (13/3/07)
1	A ¹	P ¹	P ¹
2	P ¹	A ¹	P ¹
3	P ²	A ¹	P ¹
4	A ²	P ¹	P ¹
5	P ¹	P ¹	P ¹
6	P ¹	A ¹	P ¹
7	A ²	A ¹	P ¹
8	P ²	P ¹	P ¹
9	A ¹	A ¹	P ¹

- A¹ = White, powdery pit additive (7 samples; 2 administered week 1 and 5 week 2)
- A² = Coarse, brown pit additive (2 samples; administered in week 1)
- P¹ = White CMC placebo (3 added week 1, 4 week 2 and 9 week 3)
- P² = Layer mash placebo (2 added week 1)

The manufacturer said that the two samples tested contained the same "active ingredient" but were mixed with two different bulking agents. One set of samples (7) contained a uniform white powder (according to the manufacturer this was calcium carbonate to "enhance oxygen necessary for activation of bacteria") and the second (2 samples) was a coarser, less dense brown mixture resembling chicken food mash (described as a bran carrier). Total number of samples was 9.

Table 4.3: Results of field pit additive trial 27/2/07 - 13/3/07

Site	Description	Top of Heap	Seat Height	Treat/Plac	Slope	No. Users	Age (yrs)	Comments
1	Blair Loo- ferrocement 27/2	1.42	0.57	A ¹	0.4	2	15	Residence has internal flush loo
	6/3	1.4		P ¹	0.6			Use toilet paper
	13/3	1.42		P ¹	1			Fly larvae
2	Rnd. Corr. Iron- unimp. 27/2	0.9	0.5	P ¹	0.7	9	12	V. smelly, flies, steep mainly n-paper, use ash/dip
	6/3	0.92		A ¹	0.8			Fly larvae in large numbers
	13/3	0.96		P ¹	0.7			
3	Sq. Corr. Iron- unimp. 27/2	1.02	0.48	P ²	-	7	10	Smelly, flies and larvae.
	6/3	1		A ¹	0.3			News paper, toilet paper & plastic bags.
	13/3	1.02		P ¹	0.5			Large number of larvae
4	Twin VIP- right 27/2	0.75	0.4	A ²	1.4	6	10	Well maintained, clean, no smell or flies
	Phungulutho 6/3	0.8		P ¹	1.4			Use toilet paper
	13/3	0.8		P ¹	1.4			
5	Twin VIP- left 27/2	1.2	0.4	P ¹	1	6	10	As above
	Phungulutho 6/3	1.3		P ¹	1.5			
	13/3	1.25		P ¹	1.5			
6	School- 1st on right 27/2	1.47	0.4	P ¹	0.6	520/13	12	Flies and larvae
	6/3	1.48		A ¹	1			Plastic chip & bread packets
	13/3	1.48		P ¹	0.8			
7	School- 2nd from right 27/2	0.3	0.4	A ²	Full	520/13	12	Flies and larvae, full to base of pedestal
	6/3	0.3		A ¹	Full			
	13/3	0.3		P ¹	Full			
8	School- 3rd from right 27/2	0.6	0.4	P ²	0.2	520/13	12	Flies and larvae, flat lid, no vent pipe
	6/3	0.6		P ¹	0.2			
	13/3	0.55		P ¹	0.2			
9	School- 4th from right 27/2	1.2	0.4	A ¹	0.4	520/13	12	Flies and larvae, vent pipe dropped into sludge.
	6/3	1.21		A ¹	0.55			
	13/3	1.2		P ¹	0.5			

A¹ = white additive (7)

A² = bran additive (2)

P¹ = placebo (CMC)

P² = placebo (layer mash)

Table 4.4: Change in height of pit contents after 1 week, change between 1 week and 2 weeks and nett change in height (difference between week 2 height and initial height)

Pit Latrine	Description	Week 1	Week 2	Δ Week 1*	Δ Week 2*	Nett Δ *
1	Blair ferocement	A1	-	+2 cm	-2 cm	0
2	Round corr. iron	-	A1	-2 cm	-4 cm	-6 cm
3	Square corr. iron	-	A1	+2 cm	-2 cm	0
4	Twin VIP right	A2	-	-5 cm	0	-5 cm
5	Twin VIP left	-	-	-10 cm	+5 cm	-5 cm
6	School 1	-	A1	-1 cm	0	-1 cm
7	School 2	A2	A1	0	0	0
8	School 3	-	-	0	+5 cm	+5 cm
9	School 4	A1	A1	-1 cm	+1 cm	0

¹ White powdery additive administered

² Coarse brown pit additive administered

- indicates that a placebo was administered

*A negative change indicates a drop in the height of the heap (i.e. a loss of material), and a positive change indicates an increase in the height of the heap (i.e. a gain)

To reduce potential bias, nine placebos similar in appearance to the samples were prepared; a biologically and chemically inert compound, carboxymethyl cellulose, closely resembled the white powder samples and a chicken layer mash resembled the bran carrier samples (with a 13% protein content this placebo could not be considered biologically inert).

The samples and placebos were repackaged into plastic bags and assigned random numbers. The treatments were assigned randomly to the nine pits and administered in the first and second weeks as indicated in Table 4.2. The samples, weighing between 75 and 100 grams, were shaken out of the bags and onto the heap in accordance with the manufacturer's instructions. In the third week a plastic bag of carboxymethyl cellulose (75 -100g) was added to all nine pits as the white powder reflected the torch light and assisted measurement. Table 4.2 shows the allocation of additives and placebos to the pits in the study.

4.3.3 Results

Table 4.3 presents a summary of the observations of the nine latrines and their respective treatments. Table 4.4 summarises the changes in pit content height. The findings record a net drop (comparing measurements in week 3 with the corresponding measurements from week 1) in the height of the pit contents in four of the latrines. Of these latrines, one had received an additive in week 1, two had received additives in week 2 and the fourth had received no additive at all. There was no change in the height of contents in 4 of the latrines. One of these latrines had received an additive in week 1, one latrine an additive in week 2 and two latrines had received additives in both weeks 1 and 2. Only one latrine showed a net increase in height of contents and this pit had received no additives. In two pits the height of pit contents were recorded as increasing by 2 cm in one week and decreasing by 2 cm in the following week. One pit that received no additive recorded a 10 cm decrease after the first week and a 5 cm increase after the second week. The greatest recorded decrease in height of pit contents was 10 cm (4 inches) in a week, but without addition of additive and the greatest increase in height was 5 cm. This increase was observed in the same pit as the 10 cm decrease, as well as others.

Statistically, there were no detectable correlations between treatment with any of the additives or placebos and rate of increase or decrease.

It should be noted that the height of the heap refers to the highest point of the heap that may be, and usually was, steeply sloped. A difference of 50 to 100 mm in height may therefore indicate a comparatively small

change in actual volume of pit contents, particularly when considered as a proportion of total pit contents. The measure of slope is consequently an important parameter but the estimates by eye do not appear sufficiently accurate to be considered reliable.

4.3.4 Discussion

Observations of this preliminary study will be discussed under four headings; (i) pit latrine additives, (ii) measuring technique and equipment, (iii) latrines and (iv) users and usage.

4.3.4.1 Pit latrine additives

Due to the variation in latrine design, age, usage and number of users, the pits varied considerably in the volume, composition and ambient conditions of the sludge contents. Given that a number of parameters (e.g. pH, temperature, moisture content, available oxygen, inhibitory substances, etc.) influence biological/chemical enzymatic/catalytic activity, it should be expected that any effect of the additives will differ considerably in mechanism and extent between different pits.

It was not possible to observe any significant difference between the effect of additives and placebos on the height of pit contents. Neither did the additive samples tested in this study appeared to have any effect on the odour or number of fly larvae for the two weeks that observations were recorded under the conditions prevailing at that time.

No conclusions may be made about the effect of regular dosage with additives since only two pits were treated with additives on both weeks and neither showed any decrease in height of pit contents.

It is interesting to observe that the “control” for this study, (pit 8 was not treated with additives on either week) showed the largest net increase in absolute height of pit contents. However, it will be seen in section 4.3.4.2 that this is not a significant increase, and that no scientific conclusion may be made from this observation.

These data neither support nor refute the hypothesis that commercial pit additives can influence the rate of accumulation in pit latrine contents for the following reasons:

- Additives were only obtained from one supplier. The results cannot necessarily be extrapolated to other products;
- There was no reference point against which to compare these results (e.g. rate of pit height increase before the start of the test); therefore no conclusions may be made about how the treatments changed conditions in the pits;
- The tests were only two weeks in duration, making it difficult to predict what the effect of long term treatment might be.

Nevertheless, the *amazing results* that have been claimed for many products were certainly not observed. However, the exercise of undertaking the study brought to light a number of significant issues which it is believed should be adequately addressed before the performance (or lack thereof) of additives is considered.

4.3.4.2 Measuring technique and equipment

The major effect that this study aimed to observe was whether the use of additives reduced the volume of pit contents. The pit contents usually do not present a flat surface; therefore measurement of the change in distance between the top of the heap and the pedestal with time does not translate directly into measurement in the change of pit content volume. The simplest method of estimating pit content volume is to assume that the surface is conical; i.e. the volume of pit material can be estimated by the height of the cone and the slope between the top of the cone and the pit walls. The pit dimensions must also be known.

In this study, two types of measurement were performed on each pit: Firstly the maximum height of the pit contents measured through the pedestal hole was recorded quantitatively; secondly, the slope of the pit contents was estimated. There are a number of significant disadvantages to both of these techniques.

- *Pit contents height measurement:* Lowering a graduated, weighted string through the pedestal of latrines to measure the distance from top of heap to underside of seat proved time consuming and required a careful and reproducible technique. In poor light, with time constraints or with careless operators, results could prove inaccurate. From a hygiene perspective the technique was potentially hazardous.
- *Estimation of cone slope:* The vertical distance is a function of the distance to the back wall (i.e. pit dimensions) and therefore is not a reliable indication of the slope of the contents. Attempts to estimate the vertical distance of the slope by eye had mixed results and varied from identical week to week estimates to highly variable (e.g. 0.4, 0.6 and 1 or 0.6, 1 and 0.8).

The profile of the heap and the slope of the pit contents from top of heap to the lowest point (generally the back wall) is influenced by the moisture content of the sludge, activity of fly larvae, type of anal cleansing material used and the extent to which the pit is used to dispose of other extraneous material. Clearly, the depth of a steeply sloping or pointed heap can be more easily reduced by addition of liquid or the activity of fly larvae than a flatter heap.

The critical issue is to accurately determine the change in volume of pit contents; neither the distance to top of heap nor slope of heap directly does either. It is important that any kind of pit additive study has a very clear approach to measurement of the effect of the additive and takes these factors into account. It is possible that activities such as adding water or mixing pit contents (both beneficial in their own way to biological processes) have the added effect of reducing the cone steepness and therefore reducing the apparent volume of the pit contents.

In conclusion, the measurement techniques used in a pit additive study must allow the estimation of a reliable indicator of pit contents volume, and adequate measurement of physical and biological effects of the treatment method (e.g. adding water/stirring/injecting) must also be made so that the effect of the additive may be isolated and quantified.

4.3.4.3 *Latrine design*

A number of different types of pit latrine were seen in this study (See images in the photographic library) and the condition of the pits varied significantly.

The worst smelling units with an extensive infestation of larvae were two unimproved, unventilated pit latrines with light penetrating the pit interior. Conversely the double VIPs with appropriate vent pipes and dark pits were virtually odourless and were fly-free. Fly and odour problems were encountered with VIPs that were full to the base of the pedestal, had a gap surrounding the vent pipe base, had too short a vent pipe to pull air effectively or had a pipe that had slipped down into the pit, or pits with damaged or broken lids

These observations support the experience of sanitation professionals consulted by the project team that agree that design, construction and structural maintenance of the latrines have a major impact on latrine performance with regard to odour and the presence of fly larvae.

4.3.4.4 *Users and usage*

There appeared to be a correlation between general appearance and condition of the latrines and the following factors:

- *Ownership-* the school latrines were in the worst state. Six of the 19 latrines were unusable, and of the remaining 13 some were full to the base of the pedestal. The domed covers on two pits had collapsed

inwards leaving the pits and their contents exposed, while some vent pipes were broken, missing or had dropped down into the pit below.

- *Owners*- the owners with neat, well maintained dwellings and surrounds had well maintained latrines whereas the latrines on neglected properties were in a poorer condition.
- *Design*- the well-constructed VIPs were better maintained than the unimproved pit latrines.
- *Number of Users*- where less than 6 people used the latrine the facility was well maintained, clean and tidy

4.3.5 Conclusions and recommendations: Field Trial

Whilst the authors appreciate that this study is too small to be conclusive, they believe the following recommendations and comment should be considered when planning future research:

4.3.5.1 Pit Latrine Additives

Because of the large interest in pit latrine additives, it is necessary that meaningful research is undertaken into their performance.

Field Testing: It is difficult to arrive at a definitive answer concerning the efficacy or otherwise of a pit latrine additive from *in vivo* field testing given the difficulty of measuring changes in total pit contents and incorporating appropriate controls.

While there is a demand for field testing, there are certain risks associated therewith:

- Without adequate controls, if a positive effect is recorded, how can this be attributed to the additive and not to any of a range of other factors?
- If there is no observable effect, a manufacturer may claim that the product was used incorrectly, the test latrines were inappropriate, the test period should have been longer, ambient conditions at the time were not typical, etc.
- Should such a trial take place and the results prove negative, what is there to stop the manufacturer or another manufacturer from releasing a "different" product the next day?

Therefore, in order for trials to be meaningful, they must be undertaken on a large scale with a large number of different pits being subjected to the same treatments, and a large number of reference pits against which the treatments may be compared. These need to include *control* pits where no action is taken, and pits which are subjected to similar treatments as those with additives, but without the commercial product so that the effects of adding water or mixing may be observed. These tests must be performed with a sufficiently large sample (ideally 30 of each treatment) since the natural variations expected between pits will mask the effects of the treatments if the sample size is not sufficiently large.

Test Protocol for Pit Latrine Additives: Given the large uncertainty and variation that will be observed in field trials, there is a need for a standardised protocol for testing the performance of the additives under controlled conditions. It is simply not possible to replicate field conditions in a controlled manner.

That certain additives may be effective under certain conditions should not be disputed. However, there is as yet insufficient evidence that the use of the additives justifies their cost. The Farm Feeds and Fertilizers Act (Act 36 of 1947) requires that all fertilizers, farm feeds and supplements are tested and registered in terms of the Act and was promulgated in order to prevent sellers from making unsubstantiated claims and deceiving consumers. Consideration should be given to extending this Act or to presenting a new Bill to include pit additives.

4.3.5.2 *Measuring technique and equipment*

For any field trial it is absolutely necessary that a standardised and reliable method of measuring pit content volume is developed. It is proposed that the measuring system should have the following features:

- the location coordinates of each latrine
- the distance to top of heap
- the shape of the heap
- the design, size and condition of the latrine structure

The system should be objective, repeatable, hygienic, rapid, easily performed and should minimise manual data logging. To this end, design of a "Faecometer" has been initiated.

- The proposed instrument with data logging functionality should be mounted in a frame that can be rested across the seat of a latrine pedestal and, by means of a laser measuring beam, the distance to the top of the heap measured and recorded.
- By pivoting the instrument and recording both the angle and distance to a lower point in the pit, it would be possible to estimate the profile of the heap. Alternatively, by taking two photographs a known distance apart, using automatic graphical analysis, the shape of the heap may be mathematically defined, and the difference in volume easily calculated. (This graphical technique has already been successfully developed in project K5/1629 for measuring the volume of contents of urine diversion toilet vaults)
- The incorporation of a GPS or GIS function would enable the position of each structure to be recorded in a GIS database

4.3.5.3 *Latrine Design and Construction*

The poor condition and unhygienic state of pit latrines may be attributed, in part, to unsuitable design and/or inferior materials and construction. From the pits observed in this study the focus of latrine design and construction appears, understandably, to have been on cost and delivery concerns rather than fitness for purpose.

The most frequently observed design and construction faults include gaps in the side, lid and vent pipe of the pit, vent pipes that are too short, lack insect screens, drop into the pit or are easily removed, pedestals that are porous (thus absorbing odour producing substances, especially urine), uncomfortable, don't close or collapse into the pit, doors that don't fit, close or withstand corrosion, roofs that leak and cubicles that are too small or have inappropriate layout and dimensions

4.3.5.4 *User Education*

The most important user impact influencing rate of accumulation of pit latrine contents is the non-faecal additions to the vault or pit. These comprise anal cleansing material (newsprint is widely used), refuse and additives such as Jeye's Fluid, insecticides and ash. Certain practices may be beneficial e.g. use of toilet paper will contribute to extending the useful life of the pit, ash on the heap may reduce odours and fly breeding, while some practices may be disadvantageous e.g. use of newsprint and plastic will reduce pit life and disinfectants may inhibit biodegradation processes.

Fostering user ownership of sanitation facilities has been identified as an important means of reducing the amount of non-faecal material in pits but there is a lack of consistency in this approach. Attempts to create user ownership have included user education programs, a requirement for a cash contribution to construction or *sweat equity*, but these initiatives may be undermined by conflicting political agendas

4.4 Laboratory-scale testing of pit latrine additive products

In the course of this project a number of hypotheses have been proposed to describe the possible mechanism of pit latrine additives in reducing the volume or load of the contents in a pit latrine:

- a) under anaerobic conditions, a pit latrine additive might:
 - increase the overall activity of micro-organisms and thereby conversion of solids to biogas
 - increase the rate of the solubilisation step in digestion (through direct biological action or through enzyme activity), thereby converting slowly digestible solids to easily digestible (or drainable) liquid or liquid-soluble products
 - have no significant effect
- b) Under aerobic conditions, a pit latrine additive might:
 - Increase the overall activity of micro-organisms and therefore conversion of solids to biogas and new micro-organism mass
 - Increase the rate of the solubilisation step (through direct biological action or through enzyme activity), thereby converting slowly digestible solids to easily digestible (or drainable) liquid or liquid-soluble products.

Testing of pit latrine additives in the field was found to produce inconclusive results due to the difficulty of obtaining representative measurements of any condition or property within the pit (Section 4.3.4.2), and the lack of control of the test site. Furthermore, it was apparent that many of the observations drawn from field studies relate to the condition and ownership of the pit rather than the biological processes (or lack thereof) occurring within the pit.

A fundamental conclusion of this research was that the efficacy of pit latrine additives cannot be satisfactorily measured in the field. It is necessary to have an independently managed, well controlled testing protocol through which an assessment of the effect of the additive on the pit latrine contents can be made.

4.4.1 Protocols for testing pit latrine additives

One output of this project was the development of a procedure for testing commercial pit latrine to measure the effectiveness of using these products to control filling rates in a pit latrine. The aim of the protocols was to have a standard test for assessing how much additional degradation over and above natural degradation processes can be achieved by treating samples of pit latrine contents.

4.4.1.1 *Effect of sample source on trial outcomes*

An important feature of a laboratory test protocol is that there should be a clearly identifiable relationship between what occurs in the test and what the equivalent effect in a pit latrine would be. The most obvious method of complying with this requirement was the use of samples of pit latrine contents as a test substrate for these laboratory protocols. However, this approach has an immediately apparent drawback. It has been clearly shown that the contents of pit latrines show a large amount of variation in composition, and thus different pit latrine samples can be expected behave differently to one another. Further, given the particulate and heterogeneous nature of pit latrine material, it is not possible to homogenise the material to an extent that sub-samples of a mixed sample could be expected to give identical results in any testing protocol. No satisfactory method of overcoming this problem was found. However, the following points were kept in mind in the development of the testing protocols.

- Pit latrine additive products will only make direct contact with the material on the very top of the heap in a pit latrine; thus samples obtained for the purposes of testing pit latrine additives should be taken only from this uppermost layer.

- Although pit latrine content samples should be well mixed before being used in pit latrine additive trials, a random distribution in biodegradation and mass loss rates in sub-samples must be expected due to the slightly different nature of the material in each sub-sample. Thus the conclusion that a treatment has a significant effect on degradation or mass loss rates observed in control or reference treatments must be made on the basis of a systematic change observed in a number of replicates of the same treatment.
- Repeated trials using samples taken from different pit latrines should generate quantitatively different absolute values of degradation and mass loss rates. Thus the conclusion that a treatment has a significant effect on degradation or mass loss rates observed in control or reference treatments can only be based on comparison of data from different treatments within a single trial (i.e. in repeat trials, repeat control and reference treatments must also be set up).

4.4.1.2 *Hypothesis and requirements for pit latrine additive protocols*

The hypothesis to be tested by the protocols are:

- That through the biological action of micro-organisms present in pit latrine additives, the overall mass of a sample of pit latrine contents could be reduced at a faster rate than could be achieved by natural degradative processes mediated by micro-organisms present in the pit latrine contents; or
- That the addition of pit latrine additives had no significant effect on the rate of mass loss or the rate of change of composition of samples of pit latrine contents as determined by total COD, soluble COD, moisture and solids content measurements.

The pit latrine additive testing protocols were required to fulfil the following requirements:

- They should be possible to undertake in a small laboratory without requiring complicated equipment or analytical techniques
- It should be possible to test a number of different treatments in replicates using a single sample of VIP contents that has been taken only from the top of the pit
- There should be appropriate controls for comparative purposes
- The results should be easy to interpret
- The results should be quantitative

4.4.1.3 *Description of laboratory protocols for testing pit latrine additives*

The project team devised a simple honey jar test in which a sample of VIP contents, sampled from the surface of the pit beneath the pit pedestal, was mixed and divided into sub-samples of known mass (approximately 300 g each) that were placed in 300 ml screw-top honey jars. A number of treatments were applied to these units. The following terminology has been used in the sections that follow:

- A **unit** was a single honey jar containing approximately 300 g of VIP contents
- A **treatment** was a set of 3 or 5 units within a trial that have all been set up in the same way (i.e. all units that have been treated with a fixed dose of additive A.)
- A **trial** consisted of treatments (including reference and control treatments) that have been set up from a single well-mixed sample of VIP contents.
- **Aerobic** units were open with no hindrance to the movement of air between bulk air supply and the top of the VIP contents in the units.

- **Anaerobic** units were closed, limiting access of air to the VIP contents in each unit

The dosing rate of additives was calculated on a *per area basis* i.e. the recommended dosage for a standard VIP was determined as mass (or volume) additive per surface area of the pit [g/m^2] and the same dosing rate was applied to the honey jars. Tests were performed in three or five replicates. Three reference treatments (or controls) were included for comparative purposes: (i) no addition of water or chemicals (control); (ii) addition of water (water reference) and (iii) addition of an alkaline solution (alkaline reference).

The mass of the honey jars was measured when empty, immediately after filling and at intervals of approximately 3 days for between 30 and 45 days after commencement of the experiment.

COD concentration [$\text{g COD}/\text{g sample}$] moisture content [$\text{g H}_2\text{O}/\text{g sample}$] and total solids content [$\text{g TS}/\text{g sample}$] were determined on each test unit at the beginning and end of the experiment.

From these data, the following values were calculated:

- rate of mass loss in each unit
- extent of COD reduction in each unit
- extent of moisture loss in each unit

Mass loss rates, COD concentration and moisture content were compared between treatments with additives and similar measures obtained for control units and water reference units.

Details of these protocols and calculations are presented in Appendix C.

4.4.2 Testing of pit latrine additives using assessment protocols

Two trials were undertaken in the course of this project. The objectives of the first trial were

- To pilot the testing protocol to identify shortcomings in the methodology; and
- To identify the effect of oxygen availability on biodegradative processes in the test units

The second trial aimed to implement improvements to the protocols recommended in the first trial and to test the hypotheses identified in Section 4.4.2 above for a number of commercially available pit latrine additives.

4.4.2.1 Pit latrine additives: Laboratory trial 1

In Trial 1, the protocols were tested under both aerobic and anaerobic conditions. The difference in conditions was achieved by setting up two sets of test units, where screw top lids were tightly fitted to the honey jars of the *anaerobic* set and the *aerobic* set were left open. All treatments were incubated for 46 days in a fume cupboard.

Under anaerobic conditions, only a very small fraction of mass was lost from any of the test units. No water or alkaline reference units were constructed for the anaerobic set. Figure 4.1 shows the average rate of mass loss from each of the units in the anaerobic set of trial 1. These values were calculated using standard linear regression techniques.

Figure 4.1 shows a large distribution of mass loss rates across all the units. No significant change in height was observed for samples incubated under anaerobic conditions. The overall rate of mass loss from anaerobic units in trial 1 was $0.036 \text{ kg}/\text{m}^2 \text{ surface area}/\text{day}$. No clear trend could be identified in examination of the mass loss rates. The overall variation in mass loss rate between treatments was similar, with only product E showing a mass loss rate that was systematically higher for all five treatments. These results are in keeping with the expectation that a natural random distribution of degradation rates and mass loss rates would be observed within a trial due to the variable composition of the pit latrine contents used as test substrate (Section 4.4.1.1). Generally, mass loss rates were low for all units in the anaerobic set of trial 1. It

was noted that although the relative variation between rates calculated in the anaerobic test appeared to be large, the absolute variation in rates was actually larger in the aerobic tests (data presented in detail below). This confirms that the variations in the anaerobic test may be ascribed to factors associated with the heterogeneity of the material tested rather than differences in treatment.

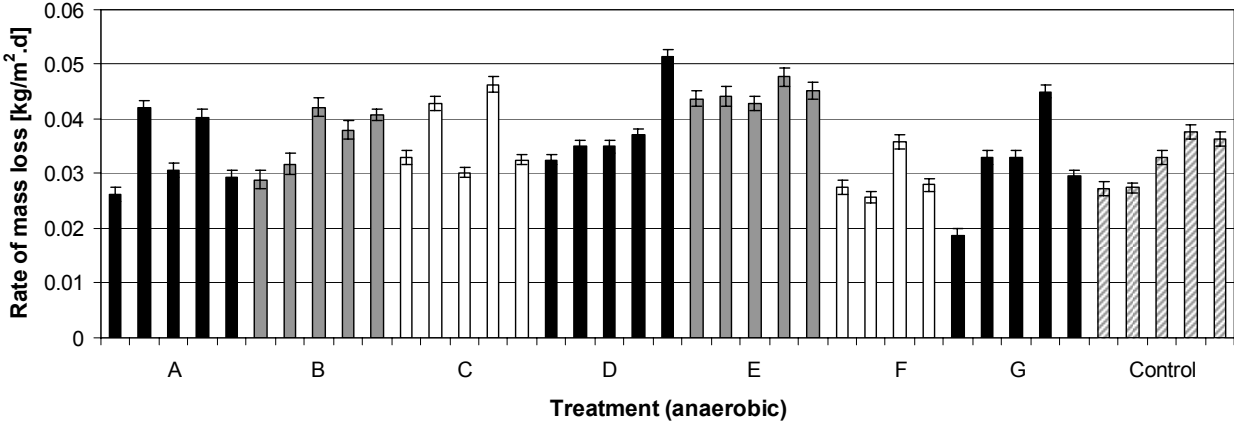

Figure 4.1: Laboratory trial 1: Anaerobic set (honey jars sealed with screw-on lids). Average rate of mass loss after 46 days of incubation at 25 °C. Seven pit latrine additives (A to G) were tested in 5 replicates. Controls indicate samples incubated without additional water or chemical/biological additive. Error bars indicate 95% confidence interval on the rate of mass loss.

These results imply that for all of the treatments considered under anaerobic conditions, the amount of biological activity is insignificant (all treatments lost less than 3% of their original mass under the conditions tested).

In contrast to the results obtained under anaerobic conditions, when the test units were left open to the air (i.e. without lids), higher mass loss rates were recorded. The average rate of mass loss across all aerobic units in trial 1 was 0.80 kg/ m² surface area/day (Figure 4.2).

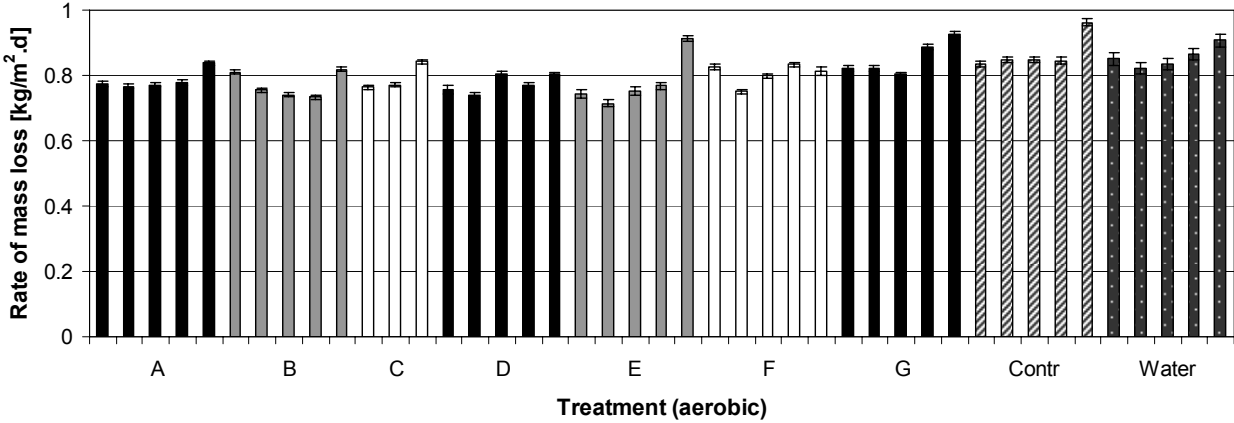

Figure 4.2 Laboratory trial 1: Aerobic set (open honey jars). Average rate of mass loss after 46 days of incubation at 25 °C. Seven pit latrine additives (A to G) were tested in 5 replicates. Contr indicate samples incubated without additional water or chemical/biological additive. Water indicates samples to which tap water only was added. Error bars indicate 95% confidence interval on the rate of mass loss.

The average rate of mass loss in aerobic units was more than 22 times greater than the equivalent rate of mass loss in anaerobic units. This result clearly indicates that the processes that facilitate mass reduction in pit latrine samples require exposure to air. These include dehydration and biological conversion of organic material to gases.

Figure 4.2 shows that there was very little difference between any of the treatments. Once again a distribution of mass loss rates was observed between units within a treatment. None of the treatments showed a systematic improvement in mass loss rate across all units within the treatment compared to either the control or the water reference units. These relationships are shown in greater detail in Figure 4.3, which shows data for each additive treatment and water reference units compared to equivalent data from the control treatment. Each data set was fitted with a straight line by linear regression. For this trial, it was observed that the regressed line for the controls fell above the regressed line for each of the other treatments; i.e. the amount of mass loss appeared to be consistently greater in control units than in units treated with commercial additives. However, it was found that the difference was not statistically significant for any of the combinations shown. Thus it was concluded that for trial 1, proprietary additives A to G did not have a significant effect (either positive or negative) on the rate of natural mass loss processes that occurred within samples of pit latrine contents.

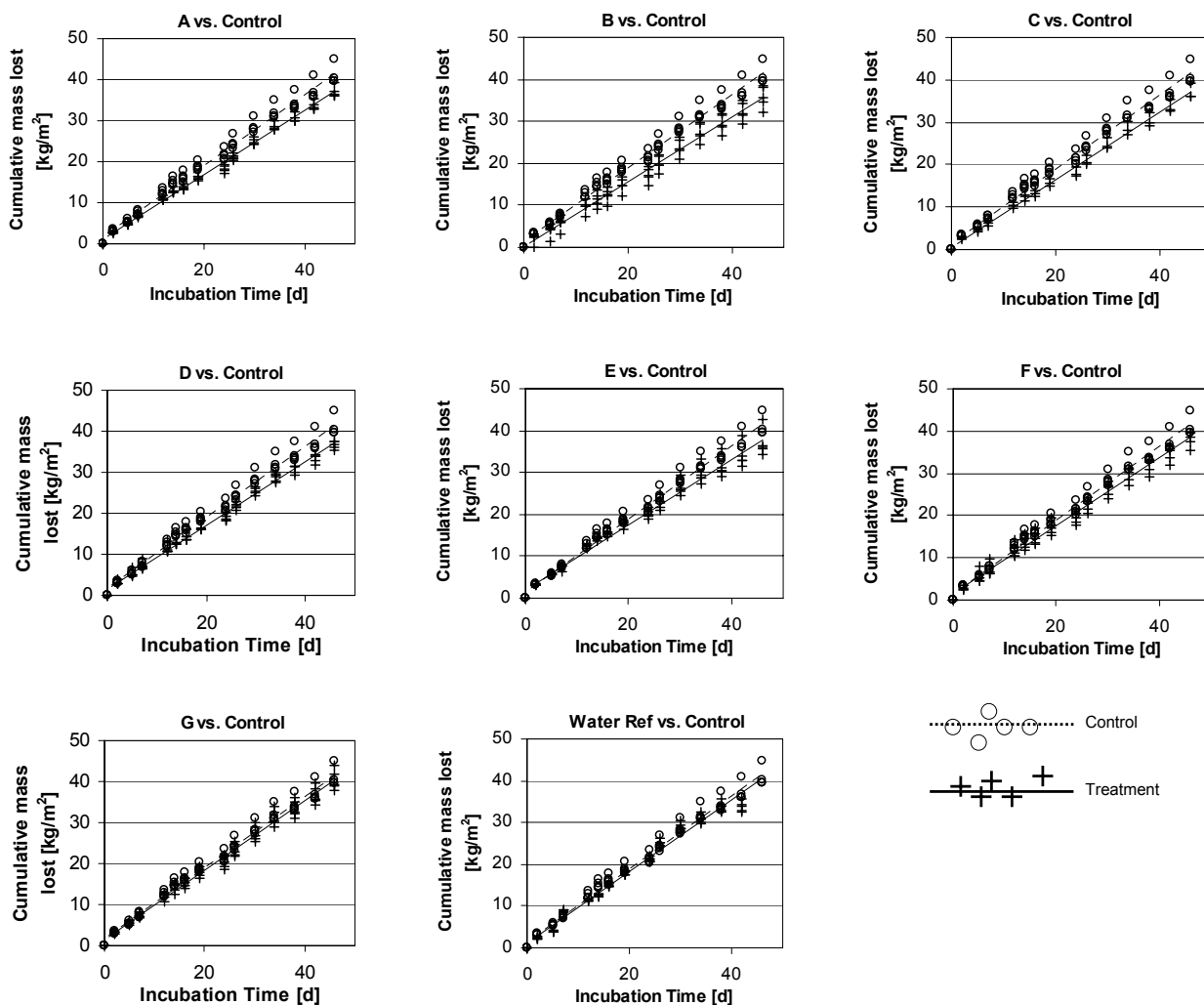

Figure 4.3: Trial 1 (Aerobic units): Cumulative mass lost from treatments A to G and water reference compared to similar mass loss data from control units. Each graph shows data from 5 replicates of each treatment.

Measurements of moisture and COD concentration were made in the bulk sample before the start of the trial, and on samples taken from the surface of three of five replicates from each aerobic treatment at the end of the trial. Results of these analyses are presented in Table 4.5

Table 4.5: Trial 1 (aerobic units): Moisture and COD concentration measured (i) in the bulk sample of pit latrine contents used in trial 1 before the start of the trial (initial), and from the surface of the aerobic units at the end of the aerobic trial (final). Final values are presented as a 95% confidence interval of the mean (number of observations)

	Moisture [g H ₂ O/g wet sample]	COD [mg COD/g dry sample]
Initial	0.83	1 100
Final	0.60 – 0.64 (n=27)	450 – 550 (n=27)

The initial moisture content was found to be 0.83 g H₂O/g wet sample. This value is extremely high, higher than any other moisture content measured in pit latrine contents in the course of this project (See Table 3.3) and similar to maximum values recorded in faeces (Table 3.2). As a result the COD content reported on a dry basis was also very high (1 100 mg COD/g sample). Insufficient replicates were performed to gain an indication of the variance of these values.

Statistical analysis of the data showed that there was no significant difference between final moisture or COD concentration from any of the treatments and the control. These results indicate that although both moisture and COD content decreased, the amount of moisture loss and COD reduction was independent of the treatment. The lack of replication in the initial moisture content and COD concentration data means that it is not possible to make any conclusions about the magnitude of moisture and COD reduction with any certainty. Furthermore, since only surface samples were analysed, (and the surface is expected to have undergone a greater degree of dehydration and biological degradation than the buried bulk) it was also not possible to perform a mass balance to determine how much of the overall mass loss could be attributed to moisture loss.

A major recommendation arose from analysis of the results of trial 1: Moisture loss through dehydration may have had a significant effect on the interpretation of the results of trial 1 under aerobic conditions. Thus it was proposed that the protocols should be modified to supply test units with air saturated with moisture in an attempt to reduce the overall rate of dehydration so that any degradative effects that could not be identified in trial 1 due to moisture loss dominating the data could have a greater chance of being identified.

4.4.2.2 *Pit latrine additives: Laboratory trial 2*

There were a number of short-comings in the first trial of the pit latrine additives testing protocol:

- Many of the pit latrine additives used in trial 1 had been in the possession of the project team for some time, and may have been regarded as having exceeded their shelf-life. Hence it was proposed that the trials be repeated with fresh additives.
- Pit latrine contents were obtained from only one pit latrine. The origin and composition of the contents may have had an effect on the results that would be obtained from the trials. Therefore, the trials should be repeated on pit contents from a different pit latrine.
- The pit latrine additives tested in trial 1 did not represent the entire range of products available on the general market. Thus the trial should be extended to include more products.
- With the data available, it was not possible to identify the contribution of moisture loss to the overall mass loss. Since commercial pit latrine additives should not strongly affect the rate at which moisture is lost, the moisture loss may have masked a smaller effect of mass loss due to biological activity.

Further, the moisture loss may in fact have reduced biological activity. Thus the trials should be repeated under conditions that would reduce the rate of dehydration.

Trial 2 followed the same basic protocol as trial 1, using fresh additives that had been recently acquired from a number of suppliers, including some of the same brands tested in trial 1, and a number of new brands. Three of the additive brands tested in trial 1 were used again in trial 2 while the remaining 4 had not been previously tested. A number of other products were also supplied to the project team, but could not be tested within this project.

To reduce the rate of dehydration from test units, honey jars were placed in covered (but not sealed) plastic boxes within the fume cupboard to reduce forced ventilation by the fume cupboard extractor fans. The air supply to these boxes was passed through water to ensure that it was saturated with moisture, thereby reducing the driving force for dehydration between the unit contents and the air.

Only aerobic units were set up since it had been shown that overall rates of mass loss were insignificant under anaerobic conditions. Only three replicates were used for each treatment, and the trial was terminated after 27 days.

Figure 4.4 presents the rate of mass loss from each of the units in trial 2. It was observed that the variance in rate of mass loss was higher for trial 2 than trial 1; the overall variance of slopes in the aerobic set of trial 1 was $3.1 \times 10^{-3} \text{ kg/m}^2 \cdot \text{d}$, while that for trial 2 was $2.7 \times 10^{-2} \text{ kg/m}^2 \cdot \text{d}$. There were two mathematical reasons for this difference; firstly, only 3 replicates were used in trial 2, while 5 were used in trial 1, and the length of the experiment in trial 2 was shorter than in trial 1, resulting in fewer data points (10 vs. 15 for each unit). However, examination of Figure 4.2 and Figure 4.4 suggests that the variation in mass loss rate due to dehydration or biological activity may also have been greater in trial 2 compared to trial 1.

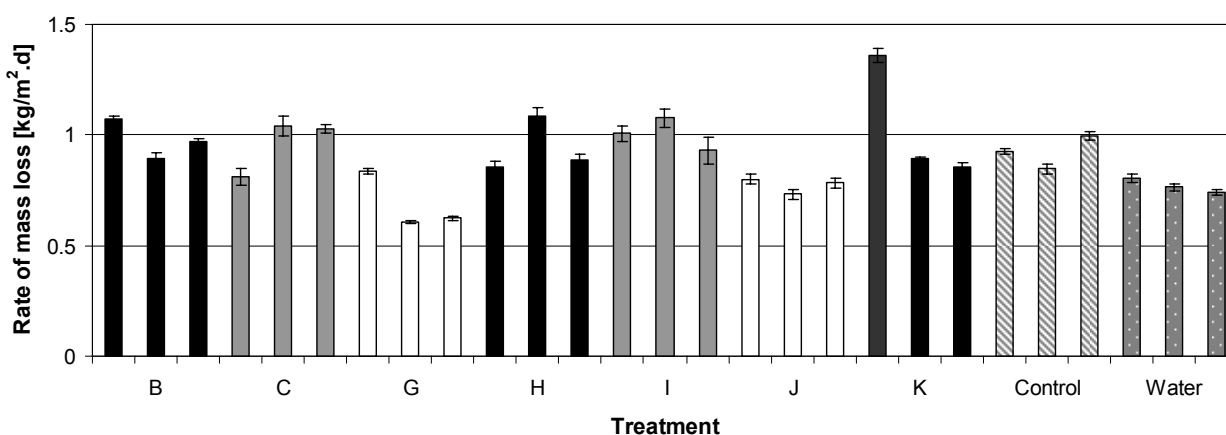

Figure 4.4: Laboratory trial 2: Aerobic set (honey jars sealed with screw-on lids). Average rate of mass loss after 46 days of incubation at 25 °C. Seven pit latrine additives were tested in 3 replicates. *Control* indicate samples incubated without additional water or chemical/biological additive. *Water* indicates samples to which tap water only was added. Error bars indicate 95% confidence interval on the rate of mass loss.

The overall rate of mass loss from all units in trial 2 was $0.90 \text{ kg/m}^2 \text{ surface area/day}$. Comparison of the mass loss rates from the control sets of trial 1 and 2 indicated that although the data from trial 2 appeared to indicate that the mass loss occurred at a higher rate in trial 2 than in trial 1, the difference was not statistically significant (Welch test, $P=0.48$). Similarly, by considering the entire set of regressed mass loss rates across all aerobic units in trial 1 and trial 2 despite an apparent increase in mass loss rate, the difference was not statistically significant (Welch test, $P=0.47$). Thus it may be concluded that for these two trials, the source of pit latrine contents did not have a significant effect on the results. However, this

conclusion may have been different if the average mass loss rate for each unit in trial 2 could have been determined with greater certainty (i.e. with a smaller confidence interval on the reported value). This conclusion also does not take into account differences in prevailing conditions of the test, specifically the supply of saturated air to test units.

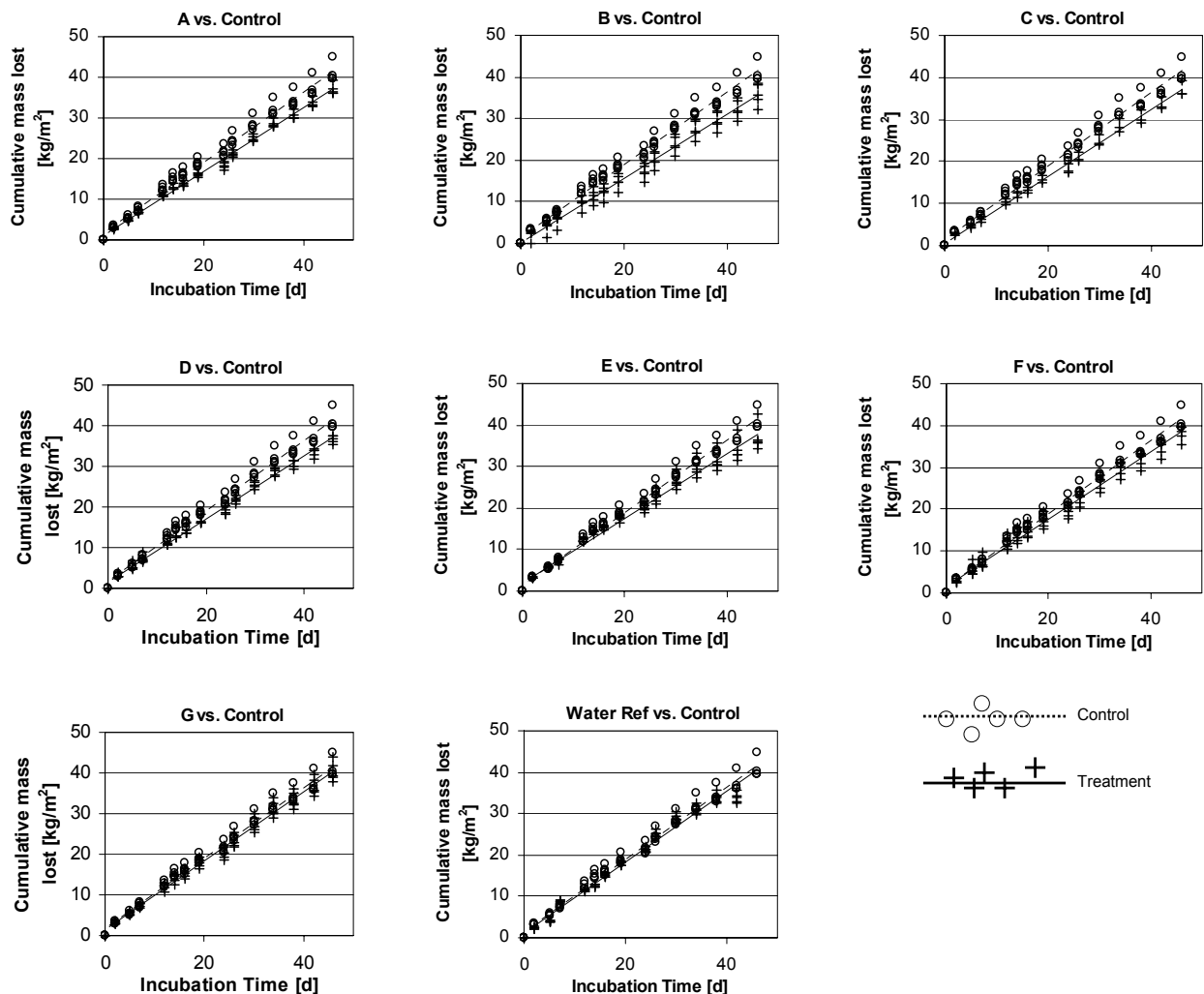

Figure 4.5: Trial 2: Cumulative mass lost from treatments B, C, G, and H to K and water references compared to similar mass loss data from control units. Each graph shows data from 3 replicates of each treatment.

Figure 4.5 presents cumulative mass loss data from treatments with commercial pit latrine additives and the water references compared to the control units for trial 2. In all cases, the average regression line for the treatment is similar to that of the control. However, unlike the observation in trial 1, the regression lines of certain of the treatments (B, H and I) were above those of the control. To test whether the apparent differences were statistically significant or not, the regression slope data (including the calculated variances of the regression slopes) were subjected to a Welch test to determine the probability that the mean slopes of the treatment and control slopes were significantly different. In all comparisons, the Welch test returned $P > 0.45$; i.e. the probability that the slopes were not significantly different was greater than 45%¹, and therefore none of the treatments resulted in significantly greater mass loss rates than observed in the control.

¹ A difference is only considered to be statistically significant if the probability that the two values are the same is less than 5%.

These results confirm the findings of trial 1 that treatment of pit latrine contents with commercial additives under the conditions used in the laboratory protocols resulted in no significant difference to the rate of mass loss from the samples.

Table 4.6: Trial 2: Moisture and COD concentration measured (i) in the bulk sample of pit latrine contents used in trial 1 before the start of the trial (initial), and from the surface of the aerobic units at the end of the aerobic trial (final). Final values are presented as a 95% confidence interval of the mean (number of observations)

	Moisture [g H ₂ O/g wet sample]	COD [mg COD/g dry sample]
Initial	0.78	730
Final	0.71 – 0.78 (n=14)	630 – 950 (n=14)

A further interesting result was that the rate of mass loss from trial 2 was similar to that of trial 1 despite the fact that the rate of dehydration was less as a result of the air supply being saturated with water. Examination of the moisture data (Table 4.6) showed that the final moisture content in the units at the end of trial 2 was significantly higher than those recorded in trial 1, and in fact similar to the initial value. Thus it appears that supplying saturated air to the units resulted in a reduction in the rate of dehydration, and it must therefore be concluded that a significant fraction of the overall mass loss in the units in trial 2 was due to biological conversion of organic material to carbon dioxide. Furthermore, in trial 1, it would appear that some of the mass loss observed was due to dehydration. It follows that the rate of biological activity in trial 2 must have been higher than in trial 1 if the overall mass loss rates were similar.

Table 4.6 presents the initial and final moisture content and COD concentrations measured from the surface of units in trial 2. Once again, lack of replication of the initial values limits the importance that can be placed on the amount of moisture and COD loss. As observed in trial 1, there was no significant difference between the final moisture content and COD concentration measured in any of the treatments and the control. This may be due to the insensitivity of the tests for complex heterogeneous material, but certainly does not support any hypothesis that treatment of pit latrine contents with commercial pit latrine additives has any measurable effect on the biological activity in the pit latrine material.

4.4.3 Discussion of laboratory trials on commercial pit latrine additives

Two trials were performed to test the hypothesis that the use of commercial pit latrine additives could accelerate the rate of mass loss in pit latrine samples, or the rate of biological activity in pit latrine samples. In the preceding sections, it was shown that the data obtained in these trials did not support either of these hypotheses. It was observed that the rate of mass loss and biological activity in pit latrine samples was significant under aerobic conditions that had *not* been treated with commercial additives, while no statistically verifiable effect of treatment with a range of these additives could be observed on mass loss and biological activity rates.

These findings are to a certain extent in contradiction of findings of other studies into pit latrine additives (Jere et al., 1998; Taljaard et al., 2003). However, unlike Taljaard et al. (2003), this study was designed to test the commercial additives at the dosage rate [g/m² surface area] at which they would normally be applied, and unlike Jere et al. (1998) using the same application technique as would normally be applied.

4.4.3.1 Micro-organism load in commercial additives vs. pit contents

In order to explain the results obtained in this study, the project team hypothesised that commercial pit latrine additives consisting of preserved micro-organisms capable of degrading organic material are able to digest

organic material found in pit latrine contents, but that the number of active micro-organisms dosed to the pit in an application of a commercial pit latrine additive is orders of magnitude less than the number already present in the pit latrine contents. This is in keeping with the overall theory proposed in this report that significant degradation occurs in the top (aerobic) layer of the pit latrine due to the activity of micro-organisms that originate from faeces, the soil and any additional organic material that may be added to the pit latrine.

To test this hypothesis, samples of pit latrine additive and pit latrine contents cultured on a nutrient agar medium. As this was only a rough initial test, results obtained are not statistically verifiable. However observations indicated that the plate-able micro-organism concentration per gram of pit latrine contents was of a similar order of magnitude to the concentration per gram of commercial pit latrine additives. If these results are correct, they imply that, in order to achieve a 50% increase in the rate of degradation in the surface of the pit latrine contents, a mass of commercial pit latrine additive of 50% of the mass of VIP solids in the pit surface layer must be added. For a pit with a surface area of approximately 1.4 m² and assuming the surface layer can be taken to be between 20 and 50 mm deep, the volume of pit latrine contents in the surface layer can be calculated to be between 28 and 70 ℓ, i.e. probably between 30 and 80 kg. Thus between 15 and 40 kg of additive (on a dry basis in their present formulation) would have to be supplied to the pit on a regular basis to ensure that the degradation rate remained 50% higher than that which would occur anyway.

4.4.3.2 Fate of additives beneath the surface layer

This project has proposed that the mechanism of degradation that occurs in a pit is a natural one in which a significant portion of biodegradable material is aerobically degraded by micro-organisms already present in faeces and soil while it resides on the surface of the pit. When the material in question is covered over, the rate of degradation drops due to a reduction in the availability of oxygen to micro-organisms. Thereafter, a slow process of anaerobic digestion results in further degradation of remaining biodegradable material. After a certain residence time in the pit, it is hypothesised that virtually all biodegradable material has been converted to biogas or non-degradable solids, and what remains in the lower levels of the pit contents is biologically inert solids.

The fate of micro-organisms added as part of a commercial pit additive formulation would be similar to that of a naturally occurring micro-organism in that, once it was covered over, limitation of oxygen supply would result in the activity of the micro-organisms dropping dramatically.

Preliminary result from a project that is in progress at the time of writing this report (WRC K5/1745 After the pit is full then what? Strategies to manage on-site dry sanitation systems into the future) indicate that there is very little biodegradable material left in the lower layers of material accumulated in a pit latrine at the time of pit exhumation. These results imply that claims that commercial pit latrine additives that consist of micro-organisms can have very little effect on this material, and thus call into question the claims that pit latrine additives can result in the complete reduction of pit latrine contents with consistent use.

4.4.3.3 Economics of treatment with commercial pit latrine additives

The results of this study indicate that at the dosage rates applied, commercial pit latrine additives do not significantly alter the rate of mass loss of pit contents. This implies that in a pit that is in use, commercial pit latrine additives would not significantly reduce the rate of accumulation of pit latrine contents. The apparent reason for this conclusion is that the load of micro-organisms applied to the pit latrine contents is small compared to the load of active micro-organisms already present in the pit. Thus the amount of additional biodegradation that occurs as a result of addition of micro-organisms to the pit is small compared to that which occurs naturally.

Despite these findings, there is still a strong drive to implement the use of these projects within municipalities and communities. However, the project team cautions that economics must be considered very carefully before embarking on pit dosing campaigns.

In a programme of pit latrine emptying in eThekweni Municipality, emptying of a single pit costs approximately R 1 100 (South African Rands) to desludge every 5 years. Emptying a pit may be regarded as doubling the life of the pit, assuming that it will refill at the same rate. In the eThekweni programme, it is planned that the same pit will be emptied again another five years later. Thus the use of additives must ensure that the pit latrine does not fill up over a 10 year period, and that the cost of using the additive must not exceed the cost of emptying the pit once, i.e. R 1 100.

If the additives are used regularly from the start of the life of the pit, as recommended by the manufacturers, the cost of dosing the pit (including distribution, and management for municipally managed projects) must not exceed $\frac{R\ 1\ 100}{10\text{years}} = R110/\text{year}$.

Alternatively, if the additive is to reduce the contents of a full pit to a negligible volume within the space of a few months (as is reported to be possible by certain of the manufacturers), the cost of the treatment with additives which achieves this must be less than R1 100.

In municipalities that lack the infrastructure found in eThekweni Municipality, the cost of pit emptying may be higher, and these numbers may look more favourable. However, the results of the laboratory protocols presented here do not support statements that treatment with commercial additives will either reduce the rate of accumulation, or reduce accumulated mass.

4.4.4 Conclusions of laboratory trials on commercial pit latrine additives

Two trials of the laboratory-scale pit latrine additive testing protocols were undertaken using commercial pit latrine additives. The following general conclusions were drawn from the results of these trials.

- (Untreated) pit latrine contents are highly heterogeneous, varying in composition, biodegradability and biological activity, both within samples from a single pit, between different layers within the same pit, and between different pits. Therefore, there is a distribution of rates of biological activity and dehydration, which may be expected to be found in any trial, whether on a laboratory or a field trial scale. Thus, a treatment may only be considered to have had an effect on these rates if it can be shown that there is a systematic and statistically significant change in the rate of mass loss or rate of biological activity in the pit latrine contents as a result of the treatment.
- Treatment of pit latrine contents with commercial pit latrine additive products had no statistically significant effect on the rate of mass loss of pit latrine contents under aerobic or anaerobic conditions
- There was no discernable difference in the final moisture content and final COD concentration in the surface of test units between treatments and controls in either of the trials, although there was a difference between the two trials. The difference was largely ascribed to the reduced dehydration rate in trial 2 as a result of aeration with saturated air. Thus there is no evidence that the rate of COD or moisture removal was accelerated by treatment with commercial pit latrine additives.
- Although overall mass loss rates were similar between the two trials, the rate of moisture loss in trial 2 was lower than in trial 1 due to aeration with saturated air. This implies that the rate of mass loss through aerobic biological activity was higher in trial 2 than in trial 1. This may be attributed to the differences in composition of the pit latrine contents used in the two trials, but may also have been affected by the fact that samples did not dehydrate to the same extent in trial 2 as they did in trial 1.

Based on these results, the project team concluded that treatment with commercial pit latrine additives under the conditions tested in these trials was not able to accelerate the rate of biodegradation or mass loss within pit latrine contents.

5 DISCUSSION

This project investigated a number of different aspects of pit latrine operation and maintenance; specifically, (i) the processes that occur in a pit latrine, and the characteristics of the material in the pit as a result of these processes (Chapter 3); and (ii) the mechanism and efficacy of commercial pit latrine additives for reducing the volume of accumulated material in a pit latrine (Chapter 4).

5.1 Processes in a pit latrine

In Chapter 3, a general theory was presented to describe the fate of organic material that enters a pit latrine. At the beginning of the project team, it was expected that the process responsible for the conversion of the majority of the organic material entering the pit was anaerobic digestion, and further that the extent of degradation that occurred in the pit was not large, resulting in poorly stabilised accumulated material. However, measurements of characteristics of pit latrine contents, and observations from the many samples handled during the project inspired the project team to propose a new theory to describe what happens to organic material in a pit; it was hypothesised that (i) all readily biodegradable material originating from faeces is aerobically degraded by naturally occurring micro-organisms within a very short time of arriving on the surface of the pit; (ii) a significant portion of the remaining biodegradable material is aerobically degraded before being covered over by new pit contents; (iii) the remaining biodegradable material, including organic residual from dead cells from micro-organisms and from the original faeces are slowly converted to soluble products, methane gas and carbon dioxide in the buried layers of the pit contents (the fraction of the original organic material that is converted by this path is not large); and finally (iv) the material that remains at the bottom of the pit latrine or after a long residence time in the pit is largely non-degradable.

5.1.1 Results of investigations into biological processes in pit latrines

Certain features of this hypothesis were well-supported by data gathered within the project. Chiefly:

- The material buried well below the pit surface is largely non-degradable (Section 3.5.2.2)
- The rate of anaerobic digestion in buried pit contents is not high (Sections 3.4.4.1 and 3.4.5.3)
- Much of the biodegradable COD (measure of organic content) has been reduced in samples within 300 mm of the surface of the pit contents (Table 3.9) since it was found that the residual biodegradability of samples was between 23 and 43% while that of fresh faeces is around 80%.
- In the trials testing the effect of commercial pit latrine additives on pit latrine sludge sampled from the surface of pit latrines on a laboratory scale (Chapter 4), it was found that pit latrine contents had a significant load of active micro-organisms that reduce the organic content of the pit latrine contents under aerobic conditions without the assistance of additional micro-organisms or moisture.

It is less clear how much degradation has occurred between the addition of organic material to the pit and the condition that the samples are in when they are removed from the pit since no measurements of the characteristics of fresh faeces were made for pit latrine users of the pit latrines studied. The tentative numbers applied to extent of digestion (Section 3.4.5.5) were based on the characteristics of faeces of people with different diets to those who used the pit latrines.

It was hypothesised that moisture loss with increasing age of pit contents was due to the slow degradation of cell matter, and that moisture loss was achieved through the release of cell contents when cell walls and membranes degraded. This explanation seems feasible given general knowledge on the nature of cell structure, but is not directly supported by any evidence from this study (except the observation that in pits which do not retain moisture, older pit contents have lower moisture content).

The new understanding of processes in pit latrines is significant because it provides a very different interpretation on what can be done either to improve operation of pit latrines, or in the management of exhumed pit contents to those.

5.1.2 Rate-limiting factors in digestion of pit contents: effect of moisture content

Results of studies on the rate of self-digestion of pit latrine samples under anaerobic conditions indicate that digestion may be facilitated by supplying additional moisture or alkalinity. However, structured experiments on the effect of additional moisture and alkalinity on the anaerobic digestion of pit latrine contents found that while additional moisture had a positive effect on anaerobic gas production rates, no effect (either positive or negative) could be identified due to the addition of sodium bicarbonate (NaHCO_3) as a source of additional alkalinity. The effect of moisture content is in line with literature (Lay et al., 1997), where it is reported that significant reduction in anaerobic activity occurs with relatively small reduction in moisture content. It is also in line with observations that the rate of accumulation in *wet* pits is lower than in *dry* pits.

This result implies that, particularly in areas where moisture drains rapidly out of pit latrines, regular addition of water (e.g. dishwashing water) may have a beneficial effect on the rate of accumulation in pit latrines by accelerating the rate of degradation that occurs within the pit latrine contents. However, it is not advisable to add so much water to the pit that water ponds on the top of the pit contents since this may encourage mosquitoes to breed in the free liquid above the pit solids. The stability of the pit should also be taken into account when adding water; water added should not result in destabilisation of the pit walls that may lead to their collapse.

5.1.3 Pathogen viability in pit latrine sludge

No systematic measurement of pathogen load was made at different depths in pit latrine material; therefore it is not possible to make any deduction about pathogen deactivation rates¹. Feachem et al. (1983) states that all pathogenic bacteria and viruses should be inactive after a few months residence time in a pit, but that eggs of helminthic parasites, particularly those of *Ascaris* spp. may persist. Pathogenic micro-organisms of all types may be expected in the top layer of a pit that is or has recently been in use.

Under the auspices of this project, an exercise was undertaken to assess whether workers involved with digging out pit latrine contents were exposed to pathogenic organisms in the pit contents. Face masks worn by workers involved in handling pit latrine sludge in the pit and by workers involved in high pressure spraying of the sludge through grids at a local wastewater treatment plant were examined. Results of analyses on both categories of face masks found viable ova of *Ascaris*, *Trichuris* and *Taenia* spp (roundworm, whipworm and tape worm) in all of the masks studied. These results indicate that irrespective of pathogen deactivation rates within the pits, there is a significant risk of infection from *Ascaris*, *Trichuris* and *Taenia* spp. for anyone working with pit latrine sludge.

5.2 Mechanism and efficacy of commercial pit latrine additives

This project undertook investigations into the use of pit latrine additives in a small-scale field trial and in well-controlled laboratory trials. Neither of these studies was able to demonstrate that the treatment of pit latrine contents with a variety of commercial pit latrine additives had any significant benefit in terms of mass or volume reduction. However, it found that significant mass and volume loss occurred in samples of pit latrine contents as a result of natural aerobic degradation processes undertaken by micro-organisms naturally present in the pit latrine contents. Although it was assumed that micro-organisms present in commercial pit latrine additives were also able to degrade the organic material in pit latrine contents, it was concluded that

¹ An exercise into the load of viable pathogens at different depths in a pit latrine is being undertaken as part of WRC project K5/1745 After the pit is full then what? Strategies to manage on-site dry sanitation systems into the future

the number of micro-organisms added at the recommended dosage rates of the commercial products was lower than the number already present and active in the untreated pit latrine contents, and thus had no significant effect on the rate of mass and volume loss from the pit latrine contents.

These results have therefore not provided any scientific evidence to support the use of commercial pit latrine additive products consisting of micro-organisms for accelerating the rate of degradation in pit latrines. However, it is possible that the practice of adding significant amounts of water to pit latrine contents, and even mixing the top layers of the contents, as recommended by certain manufacturers, may be responsible for improved organic degradation rates (either aerobic or anaerobic) in pit latrines.

5.3 Pit latrine emptying

During the course of this project, the project team was involved in extensive sampling of pit latrines, and was fortunate to be able to observe structured pit emptying exercises being carried out. Involvement in pit emptying programmes provided valuable information both in terms of the samples that were obtained from otherwise inaccessible parts of the pit, and in terms of understanding of the difficulties and hazards associated with pit latrine emptying. Appendix A contains a photographic diary of various stages of the research within this project, including pictures of pit emptying operations.

It was observed that the pit emptying process resulted in a large amount of spillage on the sides of the pit, the back plate, on the ground around the pit and on the pathway along which bins containing sludge were wheeled. In this programme, pit contents were transported by utility trucks to the nearest wastewater treatment plant and were screened in specially constructed skips with the assistance of high pressure hoses. The area in which this work was undertaken was also widely contaminated with pit latrine sludge. The general spillage observed was not the result of careless work on the part of the labourers, but a result of the extremely difficult conditions under which the labourers worked. It was also dramatically compounded by the fact that the pit latrine contained between 10 and 20% domestic solid waste, which were separated out by degrees at the emptying stage and at the screening stage.

These observations, coupled with the results of the examination of the labourer's face masks (Section 5.1.3) led the project team to conclude that even in a well-structured and well-run pit emptying programme, the risk of infection by pathogens to workers involved in pit emptying, community members and workers at the wastewater treatment plant is significant. It is recommended that a comprehensive health risk assessment of the pit emptying and associated sludge handling practices be undertaken.

5.4 Design of pit latrines

One of the proposed outcomes of this project was to guide designers and operators in improving the planning and construction of VIPs. It was initially envisaged that these guidelines should look at features of the civil design and construction of the latrines. However, the recommendations that grew out of the research findings and accumulation of observations made during the many site visits in this project pointed to the need for broader recommendations in the provision of sanitation to low-income communities without access to trunk sewers. The performance of VIPs was compared against their ability to fulfil the basic requirements of improved sanitation, i.e. to provide hygienic separation of human waste from human contact, to limit the transport of pathogens from human waste by vectors such as rodents and insects, to reduce nuisance associated with flies and odour and to preserve the dignity of the user. In general, it was found that a standard design VIP performed well as a unit designed for sludge accumulation and digestion, and fulfilled the requirements of improved sanitation if correctly constructed and maintained. However, VIPs were found to fail in a number of respects due to *poor construction, bad user habits, and during pit emptying operations*. These factors are discussed in more detail in subsequent sections.

5.4.1.1 Performance of standard VIP design for sludge accumulation and digestion

The results presented in Chapter 3 showed that in a well constructed and well maintained VIP, good digestion of organic material could be obtained. It was also shown that the higher the moisture content within the pit (provided that the surface of the pit contents was not submerged by a free liquid layer) the better the rate of digestion that could be expected to occur in the buried layers of the pit. As a result, in many pits, material below the surface of the pit contents was found to be well stabilised, and by corollary, much reduced in volume from the original material added to the pit. These results indicated that there were no fundamental flaws in the design of a VIP as a means of accumulating and degrading faecal matter over a period of time. Where pits did not operate well in degrading faecal matter, there was usually a compounding factor or factors that may have been responsible.

Integrity of construction

Observations in the course of this research showed that pits with the least smell and fly nuisance were those which complied with proper VIP construction requirements i.e. those where the ventpipe was properly mortared in place, the fly-screen was present and intact, the toilet pedestal had a seat and a door which eliminated light from the pit and where there was no place for flies to enter through the back plate. Many of the pits visited during this project were built according to accepted VIP design, but poor workmanship or vandalism had caused one or more of the above elements to be missing. For example, back plates were often missing, or placed over the pit opening so that light and insects could enter; vent pipes were often missing, or had been poorly mortared into place and had subsequently slipped down into the pit eliminating smells at head height; fly-screens were often missing completely and (according to householders) had not been part of the original construction.

Thus the principle design recommendation is that these elements are given special attention during construction through reinforcement and careful workmanship. It is equally important that the VIP owners and users are adequately educated about the importance of these features to ensure that they take responsibility for addressing minor maintenance issues, and preventing vandalism.

Construction of pit lining

Bester et al. (2000) reviewed a wide range of literature relating to design and construction of VIPs. In the section relating to pit lining, they describe a range of options and recommendations about design and materials of construction for pit lining. These are briefly summarised here:

- In stable soil conditions (i.e. where there is little risk of collapse), only the upper parts of the pit should be lined to provide a firm support for the cover slab. In unstable soil conditions where there is a significant risk of collapse, the pit should be lined from the slab to the base of the pit.
- It was recommended that for *wet pits*¹ the lower quarter and bottom of the pit are lined to retain water, and that the retention of water would result in more rapid decomposition of organic material.
- A range of materials for lining were reported including a variety of blocks, bricks, stones, perforated oil drums, geofabrics, timber and plaster.

This research has produced two relevant recommendations about pit conditions for extending the life of the pit: (i) moisture retention increases biodegradation rates; and (ii) contact with soil appears to facilitate or improve microbial activity. In the light of these recommendations, the three bullet points extracted from Bester et al. (2000) are considered.

¹ Note: this is thought to be a mistake since in wet pits, there should be no need to retain water. It would make sense if this read "dry pits"

Lining the upper section of the pit

Lining the upper section of the pit is usually necessary from a construction perspective to provide a stable foundation on which to lay a pit collar and cover slab and to prevent collapse of the usually looser top soil into the pit. However the following two points should be borne in mind when constructing the pit lining here:

- The soil nearest the surface usually has the highest load of active micro-organisms, and by constructing a pit lining that prevents contact between this soil and the pit contents any beneficial effects of this contact are eliminated.
- It appears that the resistance to movement of liquid in the pit is in the pit material, rather than in the surrounding soil or pit wall. Thus moisture added to the pit will preferentially run off the heap towards the sides of the pit and drain out of the pit at the level of the pit contents. Thus, when the pit is nearly full, the pathogen and nutrient contaminated liquid that drains out of the pit will be produced near the surface of the pit, with potential consequences for human and environmental health.

Thus it is recommended that the pit is fully sealed to a depth below the surface that prevents escape of contaminated moisture, but that immediately below this depth, the pit lining provides as much contact between soil and pit contents as possible while still providing the necessary support. This is in line with the recommendations of Bester et al. (2000) that the lining joints should be fully mortared in the top 0.5 m of the pit, but unmortared below that.

Lining of the bottom and lower quarter of the pit

The recommendation to line the bottom and lower quarter of the pit to retain moisture has merit since it has been shown in this research that additional moisture increases the rate of degradation of pit latrine contents. However, the difference between water addition and urine addition is great. Urine has a relatively high ionic strength, and more importantly, a high ammonia production potential. Both of these factors are likely to adversely affect degradation rates. In the short term, the probably result is that during the early days of use of the pit, the pit will smell worse than an equivalent pit without lining. It may also prevent initiation of healthy anaerobic digestion and cause medium term negative effects in terms of smells and filling rates. In comparison, when the pit is not sealed at the bottom, urine drains away and therefore has a smaller effect on the degradation processes.

This problem may be overcome to a certain extent by sealing the bottom of the pit, and before the pit is commissioned, water, anaerobic digester sludge or some other liquid medium should be added to the pit, filling the lined area. Addition of either liquid or solid will cause the level to rise and liquid contents to overflow. The net effect would be to keep the urine content as dilute as possible for as long as possible, allowing the establishment of a healthy micro-organism population for degradation of the material. It will also reduce the incidence of flies in the early days of pit use, but may encourage mosquito breeding if the pedestal lid is not closed or the fly screen is inadequate or missing. The initial filling of the sealed section with a liquid should not increase the filling time of the pit, and should in fact reduce this time.

Building materials for the pit lining

Except where the pit should be sealed for degradation or stability purposes, any lining should allow the maximum possible contact between soil and pit contents.

Pedestal materials and construction

In many of the VIPs visited in this project, pedestals did not have lids. In most cases, it appeared that the lids had been broken off, although a number of pedestals appeared to have been designed without lids. It is emphasised that the pedestal lid is an essential part of a ventilated *improved* pit latrine since without the lid, or without the lid being kept closed when not in use, fly-control will be poor and the system will not qualify as improved.

A further observation was that pedestals made out of cement absorbed urine, resulting in a bad smell in the entire superstructure. This factor also results in the entire unit failing to fulfil the requirements of improved sanitation in reducing odours and preserving the user's sense of self-dignity.

5.4.1.2 *Performance of standard VIP design during pit emptying*

A description of the pit emptying process in eThekweni Municipality was provided in Section 5.3. It was observed that during pit emptying operations, and subsequent handling of the exhumed sludge, there was a significant (almost certain) risk of infection by pathogens such as *Ascaris* and other nematode worm species to the pit emptiers and to the community through spillage of the pit contents. It was not clear how the risk could be reduced to an acceptable level through any affordable or practical means for the case when pit contents were manually removed from the pit. Thus, despite the relatively good performance of a VIP in sludge accumulation and degradation, the right to be considered an improved sanitation system falls away when pit emptying is factored into the life cycle of the pit latrine.

A possible solution would be the use of mechanical emptying devices which actively suck pit contents out of the pit. Research into these technologies did not form part of this project, however, it is clear that in many cases, these units would not be able to successfully empty pit latrines due to difficulties in accessing sites, water supply for liquidising the pit contents, cost of transporting the emptying device, and inability of most of these systems to handle solid waste which is invariably a significant component of pit latrine contents.

It is therefore clear that a more sustainable answer to the problem of emptying pits and handling pit latrine sludge must lie in the initial design of the VIP, and specifically in the design of the emptying system. Some factors to consider are:

Size:

The large volume of a standard VIP (often up to 2.5 m³) results in a large volume of sludge that must be handled during emptying operations. The depth of the pit is usually such that workers cannot remove sludge in the lower levels of the pit manually without actually climbing into the pit latrine. There is therefore a compromise that must be made between the frequency of emptying and the difficulty of emptying, since much smaller pits would be easier to empty, and result in less health risk to emptiers and community members than larger pits, but would necessarily have to be emptied far more regularly

Design for solids removal

In a standard VIP design, only the back-plate forms any part of the design for emptying. Additional factors should be considered facilitate the solids removal.

- One suggestion includes having a far smaller (e.g. 0.2 m³ capacity) in which a permeable bag is suspended on hooks attached to the pit collar. This bag could be removed and replaced on a 6 monthly basis (or more often if necessary) with the assistance of a hydraulic arm and appropriately designed bins. Such a system would require a dedicated team of emptiers, but the operation could be completed quickly and cleanly if the pit were suitably designed.
- Adoption of a twin pit alternating VIP design, where pit contents are only removed after a standing period of a year or more may reduce the risk of infection of workers and community members during pit emptying operations since it is generally believed that a stabilisation period of one or more years results in almost complete deactivation of pathogens. It is not clear whether stabilised faecal sludge has sufficiently reduced pathogen loads to bring the risk of infection to acceptable levels. It is recommended that more research is undertaken into the viability of pathogens in stabilised pit latrine contents.
- Another approach would be to design the pit to be emptied by the user such as has been done in the eThekweni urine-diverting double pit ventilated improved toilet (Buckley et al., 2008). These units consist of standing and filling vaults that are built with above-ground access. Urine is diverted to a

soakaway resulting in accumulated material being dry and easy to handle. When one vault is full, the pedestal is moved so that the second vault starts to fill. When the second vault is full, the homeowner then digs and scrapes out the vault contents which can then be buried nearby. The accumulated volume is sufficiently small to allow nearby burying, and the smaller construction of the vaults with easy access to remove solids results in a smaller risk of contamination during emptying operations than in a standard VIP design.

5.5 Important factors for development of policy relating to VIP latrines

This project has found that VIP latrines are able to safely accumulate and biodegrade human faecal waste. However, the ability of a VIP latrine to provide an improved sanitation service to a family or household was found to depend on four important factors that should be addressed by the authority responsible for the implementation of the sanitation service.

5.5.1 User education

In many of the pit latrines visited in this project, unhygienic conditions existed in and around the latrine due to poor user practices. Many of these are described in detail in Section 4.3.4.4. The presence of flies and maggots was usually correlated to missing or poorly fitted back plates, vent pipes, pedestals, pedestal lids or doors. In some cases, the missing items were seen near the latrine, but never repaired because the owners did not understand the importance of these features. Similarly, use of disinfectants and non-degradable anal cleansing material resulted in rapid filling rates due to poor degradation of pit contents. VIP latrine owners and users need to be educated about the importance and purpose of these features if they are expected to ensure that their latrine is able to fulfil the requirements of improved sanitation.

5.5.2 Solid Waste Management

It was observed that pits that were located near to roads along which an efficient solid waste removal programme operated effectively had a lower fraction of solid waste in the pit contents, while those in areas far away from the road, or in areas where solid waste management was poor or non-existent appeared to double as solid waste disposal sites. The presence of non-degradable solid waste in VIP latrines is a very significant problem when it comes to emptying the pit on two levels; (i) firstly, the addition of solid waste results in accelerated filling rates: the pits will fill quicker; (ii) Secondly, the difficulty of emptying a pit containing significant amounts of solid waste is much higher than in one containing only faecal sludge. The presence of solid waste is one of the major features limiting the use of mechanical emptying devices in pit latrine emptying due to the increased risk of blockage and damage to the mechanical emptier. Thus users must be educated not to use their latrines for solid waste disposal; however, the success of such an intervention would depend on their being an effective alternative solid waste removal system, particularly if householders do not regard the emptying of their pit latrine as their own responsibility.

5.5.3 Emptying

It has been observed with some unease that large scale projects have been undertaken to build VIP latrines for unsewered communities, but that inadequate planning and budgeting has been put in place to deal with the emptying, rebuilding or maintenance of full or damaged pit latrines. It is vital that the provision of sanitation by National Government and municipalities is accompanied a detailed, sustainable and appropriately budgeted and financed plan for dealing with maintenance and emptying issues that will arise in the expected life time of the pits. Without these provisions, the initial investment made in the building of the pits will be lost or wasted within 10 years of the implementation of the sanitation project

5.5.4 Maintenance

It was observed that for latrines with missing or damaged features including doors, pedestals and lids, backplates, flyscreens and vent-pipes, householders not only did not understand the importance of repairing or replacing these parts, but also did not know how to access new parts or the expertise to perform simple maintenance. This suggests that there should be a supplementary programme that ensures a supply of spare parts and the training of maintenance contractors to undertake simple maintenance work. An effective user education programme would ensure that there was an ongoing demand for such parts and services.

6 CONCLUSIONS AND RECOMMENDATIONS

This project has consisted of a number of sub-studies that have been drawn together in a single report. The project proposed to undertake field and laboratory investigations of VIPs and their contents in and around the eThekweni Municipal area in order to understand the conditions to be found in the pits and to propose design and operating practice that will extend the life of pits.

6.1 Processes in a pit latrine

Chapter 3 presented the findings of studies into processes occurring in pit latrines.

A general theory was presented to describe the fate of organic material that enters a pit latrine. On the basis of measurements of characteristics of pit latrine contents, and observations from the many samples handled during the project it was hypothesised that (i) all readily biodegradable material originating from faeces is aerobically degraded by naturally occurring micro-organisms within a very short time of arriving on the surface of the pit; (ii) a significant portion of the remaining biodegradable material is aerobically degraded before being covered over by new pit contents; (iii) the remaining biodegradable material, including organic residual from dead cells from micro-organisms and from the original faeces are slowly converted to soluble products, methane gas and carbon dioxide in the buried layers of the pit contents (the fraction of the original organic material that is converted by this path is not large); and finally (iv) the material that remains at the bottom of the pit latrine or after a long residence time in the pit is largely non-degradable.

The following additional conclusions were drawn from studies on processes in pit latrines:

- It was found that the rate of anaerobic digestion of pit latrine contents taken from the surface of the pit could be accelerated by the addition of moisture. Specifically, the rate of gas production increased by a rate of between 0.006 and 0.02 m^l gas/g total solids/day per 1% increase in moisture content above the baseline moisture level of 76%.
- The effect of increasing the alkalinity so as to increase pH buffering capacity on anaerobic digestion of faeces and samples taken from the top layer of a pit latrine was tested by addition of different amounts of sodium bicarbonate. It was found that none of the treatments with sodium bicarbonate resulted in statistically significant increases in the rate of gas production under anaerobic conditions. It was concluded that alkalinity was not a limiting factor in anaerobic digestion of pit latrine contents.
- Buried material taken from well below the surface of the pit latrine had very poor gas production potential under anaerobic conditions. Low rates of gas production were attributed to low inherent biodegradability of this material, since it was assumed that much of the biodegradable material in the original faecal material had been converted during residence on the surface of the pit contents. Thus no significant effect on gas production rate was observed by increasing moisture content or alkalinity of samples of this nature.

6.2 Health risks associated with pit latrine contents

Examination of face masks worn by workers engaged in emptying pit latrines and screening the exhumed contents indicated that viable ova of a number of helminth species including *Ascaris*, *Trichuris* and *Taenia* spp (roundworm, whipworm and tape worm) may be present in pit latrine contents and that these constitute a significant health risk to workers involved in handling pit latrine contents, and community members who have access to the area around the pit latrine during and after pit emptying operations.

This study has not elucidated the mechanism or rate of pathogen deactivation in pit latrine contents under aerobic or anaerobic conditions. However, isolation of a large number of helminth ova on workers' masks indicates that contact with the pit latrine contents carries a significant risk of infection by helminths, and potentially by other human pathogens.

6.3 Efficacy and action of additives on processes occurring in pit latrines

Chapter 4 presents the findings of a small scale field trial and a more detailed laboratory study to test the efficacy and action of commercial pit latrine additives.

Commercial pit latrine additives were found to contain large concentrations of active micro-organisms with the ability to utilise organic substrates. However, neither the field trials, nor the laboratory trials provided evidence that the use of these products could result in a significant reduction in either mass or volume of pit latrine contents. There were two probable causes of this result:

- In the study into processes in pit latrines, it was concluded that much of the biodegradable material in faecal sludge is degraded very shortly after material is added to the pit latrine, mediated by the presence of naturally occurring micro-organisms present in the pit latrine and the added faeces. Thus the residual biodegradability of pit latrine contents is low compared to added faeces, and significant decreases in the volume or mass of the bulk of the buried contents through biological degradation are not possible;
- The high concentration of naturally occurring degradative micro-organisms in the faeces and pit latrine contents was of a similar order of magnitude to the concentration in the added pit latrine additives. However the overall number of micro-organisms in the active surface layer of the pit latrine (calculated by the concentration of micro-organisms multiplied by the mass or volume of the active surface layer) was far greater than the total number of micro-organisms added with the treatment of commercial pit latrine additive. Thus, although the added micro-organisms may have been successful in degrading organic material, the increase in the rate of degradation due to treatment with pit latrine additives was negligible since high degradation rates were observed in untreated samples.

Under aerobic conditions (no limitation of oxygen supply), there was no significant increase in the rate of degradation of pit latrine contents due to the addition of commercial pit latrine additives at the recommended dosage rates (g additive/ m² pit latrine contents). Similarly under limited oxygen supply conditions (anaerobic conditions) the rate of degradation was not enhanced by addition of commercial pit latrine additives at the recommended dosage rates, and in fact, the overall rates of degradation in terms of observed mass loss from samples were considerable lower than under aerobic conditions.

A number of conclusions were drawn relating to the design of experiments for testing the efficacy and action of pit latrine additives:

- Pit latrine additive studies must be carefully designed to separate the effect of natural (unenhanced) biological activity, the method of treatment (i.e. adding water/mixing) and the effect of the additives themselves on pit processes through the implementation of appropriate control and reference experiments.
- There is a political and societal argument for field trials of pit latrine additives; however, these must be carefully designed to separate the effects of the additives and other factors through the implementation of appropriate control and reference experiments; furthermore, reliable methods of assessing volume change must be developed to measure the effect of the treatments on pit latrines since simple height measurements have been found to be subjective and do not provide an accurate measure of the volume changes in the pit.

Given the large uncertainty and variation that will be observed in field trials, there is a need for a standardised protocol for testing the performance of the additives under controlled conditions. It is simply not possible to replicate field conditions in a controlled manner. It is therefore a *strong recommendation* of the project team that conclusions about the efficacy of commercial pit latrine additives be based on controlled laboratory based experiments, rather than on field trials.

Finally, it was concluded that this study has shown no benefit in the use of pit latrine additives to accelerate the rate of degradation of pit latrine contents under either aerobic or anaerobic conditions. Furthermore, it was concluded that the financial cost of use of these additives was likely to be less than the cost of manually emptying the latrine every 5 years provided an appropriate pit emptying programme was in place.

6.4 Design of pit latrines

The standard VIP design was found to be effective for the accumulation and degradation of faecal sludge. However, it was observed that the ability of a VIP latrine to function as an improved sanitation system i.e. to provide hygienic separation of human waste from human contact, to limit the transport of pathogens from human waste by vectors such as rodents and insects, to reduce nuisance associated with flies and odour and to preserve the dignity of the user, was compromised in a number of respects due to *poor construction*, *bad user habits*, and *during pit emptying operations*. These were discussed in detail in Chapter 5 and are summarised as follows:

- It was observed that poor construction or lack of maintenance often resulted in essential features of the VIP latrine design being missing or damaged, including vent-pipes, flyscreens, pedestal lids, doors and back plates. Under these conditions, there were usually problems with odours and flies.
- Bad user habits resulted in rapid accumulation of pit contents, particularly when poorly degradable anal cleansing material such as magazines, plastic bags or stones were used. In many cases pit latrines appeared to double as waste disposal sites, resulting rapid filling of the latrines.
- During pit emptying operations, significant risk of infection of workers and community members with human pathogens originating from the pit contents is expected due to difficulties in removing pit latrine contents and separating faecal sludge from solid waste.

It was concluded that certain targeted interventions could improve the ability of the VIP to provide an improved sanitation service to the users of the latrine:

- Design changes relating to the volume of the pit and access to pit latrine contents could reduce the risk of the spread of disease during pit latrine emptying operations.
- User education should be implemented to ensure that pit latrines are properly used and maintained, thereby eliminating many of the problems associated with VIP latrines including flies, odours and rapid filling rates.
- A detailed, budgeted and financed plan to empty pit latrines and manage the exhumed sludge should be in place wherever VIPs form part of a Municipal or government plan for provision of improved sanitation.
- A supplementary programme should be in place in communities serviced with pit latrines to ensure that spare parts are available for maintenance of the units, and sufficient expertise may be found within or near to the community to undertake simple maintenance exercises identified by owners of the VIP latrines.

REFERENCES

- APHA, ed. (1998). *Standard methods for the examination of water and wastewater*, 20 Ed., American Public Health Association, American Water Works Association and Water Environment Federation, Washington, D.C.
- Bester, J. W., and Austin, L. M. (2000). "Design, construction, operation and maintenance of ventilated improved pit toilets in South Africa." *WRC Report No. 709/1/00 ISBN 1 86845 647 1*, Water Research Commission.
- Bester, J. W., Austin, L. M., and 709/1/00, W. R. N. (2000). "Design, construction, operation and maintenance of ventilated improved pit toilets in South Africa." *WRC Report No. 709/1/00 ISBN 1 86845 647 1*, Water Research Commission.
- Buckley, C. A., Foxon, K. M., Rodda, N., Brouckaert, C. J., Mantovanelli, S., and Mnguni, M. (2008). "Research into urine diversion, ventilated improved double pit toilets (UD/VIDP) in eThekweni. Part A: Physical and health-related characteristics of UD/VIDP vault contents." Water Research Commission, Pretoria.
- Chaggu, E. J. (2004). "Sustainable environmental protection using modified pit-latrines.," PhD, Wageningen University, The Netherlands.
- Cotton, A., Franceys, R., Pickford, J., and Saywell, D. (1995). "On-plot sanitation in low-income urban communities: A review of literature." <file:./%5CVIP%5CCotton%201995.pdf>.
- Couderc, A. (2007). "Improving the rate of degradation of solids from VIP latrines," Master Sciences de l'Environnement Terrestre, Université Paul Cézanne, Aix-Marseille.
- Feachem, R. G., Bradley, D. J., Garelick, H., and Mara, D. D. (1983). *Sanitation and Disease: Health Aspects of Excreta and Wastewater Management*, John Wiley and Sons, Bath.
- Franceys, R., Pickford, J., and Reed, R. (1992). "A guide to the development of on-site sanitation." WHO, Geneva.
- Henze, M., Harremoës, P., Jansen, J., and Arvin, E. (1997). *Biological and chemical processes in wastewater treatment*, Springer Verlag, Berlin, Germany.
- Jere, M., Chidavaenzi, M., Nhandara, C., and Bradley, M. (1998). "The effect of non-pathogenic bacteria on latrine sludge." In: *24th WEDC Conference: Sanitation and water for all*, WEDC, Islamabad, Pakistan.
- Lay, J.-J., Li, Y.-Y., and Noike, T. (1997). "Influences of pH and moisture content on the methane production in high-solids sludge digestion." *Water Research*, 31(6), 1518-1524.
- Lopez-Zavala, M. A., Funamizu, N., and Takakuwa, T. (2004). "Temperature effect on aerobic biodegradation of feces using sawdust as a matrix." *Water Research*, 38(9), 2406 - 2416.
- Lopez Zavala, M. A., Funamizu, N., and Takakuwa, T. (2002). "Characterization of feces for describing the aerobic biodegradation of feces." *J. Environ. Syst. and Eng., JSCE*, 720/VII-25, 99-105.
- Magagna, D. (2006). "Investigation into the processes of VIP latrine," Politecnico di Milano, Milan.

- Mara, D. (1984). "The design of Ventilated Improved Pit Latrines." *a report*.
- Martin, D. J., Potts, L. G. A., and Heslop, V. A. (2003). "Reaction mechanisms in solid-state anaerobic digestion 1. The Reaction Front Hypothesis." *Trans IChemE*, 81(B), 171-179.
- Morgan, P. (2004). "The answer lies in the soil." In: *An ecological approach to sanitation in Africa - a compilation of experiences*, EcoSanRes, SEI, Stockholm.
- Morgan, P. (2005). "An ecological approach to sanitation in Africa - A compilation of experiences." EcosanRes, ed., Aquamor, Harare Zimbabwe.
- Naidoo, S. (2005). "The relationship between buffering capacity and anaerobic digestion (AD) is a model system," BSc Hons, University of KwaZulu-Natal, Durban.
- Norris, G. A. (2000). "Sludge buildup in septic tanks, biological digesters and pit latrines in South Africa." WRC, ed.
- Owen, W. F., Stuckey, D. C., Jr, J. B. H., Young, L. Y., and McCarty, P. L. (1978). "Bioassay for monitoring biochemical methane potential and anaerobic toxicity." *Water Research*, 13(1978), 485-492.
- Palmquist, H., and Jönsson, H. (Year). "Urine, faeces, greywater and biodegradable solid waste as potential fertilizers." *2nd International Symposium on Ecological Sanitation*, Lübeck, Germany.
- Pitnet. (1996). "Pitnet: Pit latrine network newsletter #1 April 1996." <<http://www.lboro.ac.uk/departments/cv/wedc/garnet/pitnet1.html>> (07/06/2007, 2007).
- Puddifoot, J. (1995). "Pit latrines in Nepal - the refugee dimension." *Waterlines*, 14(2), 30-32.
- Speece, R. E. (1996). *Anaerobic biotechnology for Industrial Wastewaters*, Archae, Nashville, TN.
- Still, D. A. (Year). "After the pit latrine is full...What then? Effective options for pit latrine management." *WISA 2002*, Durban ICC.
- Taljaard, L., Venter, A., and Gorton, D. (2003). "Evaluation of different commercial microbial or microbially-derived products for the treatment of organic waste in pit latrines." *WRC 1377/1/05*, Water Research Commission.
- USEPA. (2002). "Onsite wastewater treatment systems Manual." *EPA/625/R-00/008*, Office of Water, Office of Research and Development, U.S. Environmental Protection Agency.

APPENDIX A: PHOTOGRAPHIC DIARY

This appendix contains a visual record of the various sampling and testing programmes that were undertaken during this project.

1 Pit contents and pit construction



Pit latrine contents sampled from the top layer of a primary school pit latrine. This sample contains mostly faecal material.



Pit latrine contents in a household pit with a large amount of domestic solid waste in the pit



Project team members engaged in exhuming buried pit latrine contents

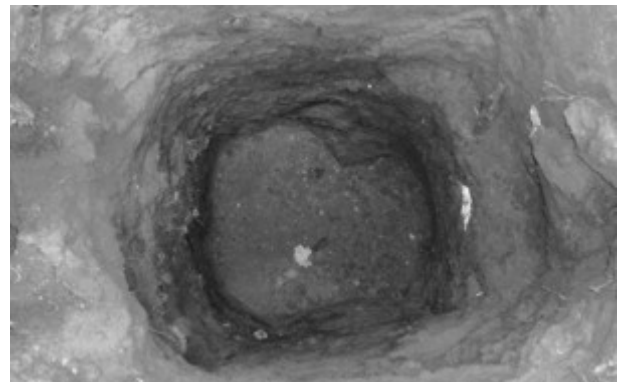

Empty pit after exhumation by project team



Relatively small amount of solid waste material from exhumed household VIP.

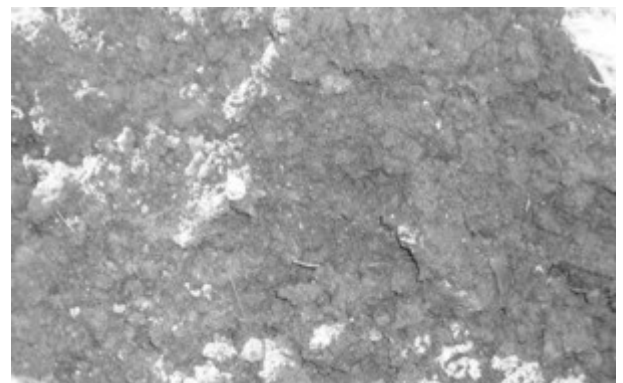

Well stabilised faecal sludge component from exhumed household VIP



Poorly maintained community VIP in Tongaat area. This VIP had no vent pipe and the back plate was broken



Rudimentary pit latrine with rickety superstructure in Maphephetheni



Overflowing VIP latrine



Corresponding pit contents of overflowing VIP latrine viewed through the opened back plate



A pit latrine after emptying has been completed. This pit latrine was fully lined with open vertical joints in the block work



Overflowing pit latrine: the superstructure has become an extension of the pit.



Walls of pit during emptying. This pit contained a very high load of maggots due to the fact that the ventpipe was missing.



Cockroaches and spiders are regular inhabitants of latrines where the back plate does not fit properly.

2 eThekwini Pit latrine emptying programme

The pictures in this section show steps in the pit emptying project in eThekwini Municipality executed by Fukamela Contractors under the project management of UWP consulting.



Pit opened for emptying



Worker inside pit latrine with minimal protection



Passing out a bucket of pit contents



Pit contents are transported to 200 l wheel bins



Project team standing by to take samples from different depths within the pit



Emptied wheel bins waiting to be filled



Offloading wheel bins at wastewater treatment plant for solid waste separation



Converted skip with grids for separating solid waste from faecal sludge. Separation is achieved with the assistance of high pressure water spraying



Solid waste remaining on the grids after spraying faecal sludge through the grids



Solid waste transferred to rubbish bags



Workers engaged in spraying solids through grid. Note accumulated solid waste in back left of image.



Collection of rubbish bags to be disposed of on landfill



Alternative sludge disposal option: burial on-site.

3 Alternating double vault urine diversion VIP toilets in eThekweni Municipality

These pictures show the construction and vault size of the eThekweni urine diversion toilets. A significant factor in favour of these units is the relative ease of emptying the vaults.



Interior of superstructure. The pedestal contains a urine diverting section for women. Men use the urinal seen on the back wall. The lid of the second vault can be seen at the right of the superstructure interior.



View into a half-filled vault of a double vault urine diverting VIP. The vault is mostly above ground.



Householders emptying a urine diverting VIP. Householders are encouraged to bury the vault contents on-site.

APPENDIX B: STUDY INTO EFFECT OF MOISTURE CONTENT AND ALKALINITY ON GAS PRODUCTION RATES FROM PIT LATRINE CONTENTS

This section summarises the work performed by Couderc and reported in her MSc Eng Thesis submitted for examination at Université Paul Cézanne, France in June 2007 (Couderc, 2007)

This study aimed to measure the affect of additional moisture and/or alkalinity on the rate of anaerobic digestion in samples of material obtained from the top layer of a pit latrine.

1 Experimental plan

These experiments aimed to compare the rate of gas production under anaerobic conditions from serum bottles containing material obtained from the top layer of a pit latrine with similar bottles with varying amounts of additional moisture and alkalinity.

A factorial matrix with two factors (moisture and alkalinity) and six levels was built. In the matrix, one axis represented moisture added with volumes from 0 to 25 ml (76% to 91% overall moisture content per unit) and the other axis represented added alkalinity from 0 to 2.5 mg NaHCO₃/bottle (Table AB.1). Each cell in the matrix represented one experiment with a specific amount of added water and/or alkalinity. Thus, 6² = 36 experiments were required and each of the 36 experiments was conducted in triplicate. Additional experiments were added as controls, and additional bottles were included for certain of the experiments so that they could be sacrificed part way through the experiment in order to determine parameters such as COD, pH, alkalinity, gas composition.

No nutrient medium solution or additional source of micro-organisms was added to these experiments.

It was hypothesised that the gas production would increase as the moisture content was increased because of improved mass transfer, decreased ionic strength and decreased organic load. In the same way, it was further hypothesised that when the alkalinity was increased, i.e. more pH buffering capacity was introduced to the experiment; the gas production would also increase as the rise in pH value due to acidogenesis was counteracted by the increased alkalinity. The implication of these hypotheses was that a higher gas production rate was expected to be achieved under the conditions on the right bottom section of Table AB.1. Additional bottles were prepared in triplicate to be sacrificed during the test. The replicated tests were T₆, T₁₆, T₁₈, T₃₃, and T₃₆ to cover a large range and to analyse the evolution of biological activity

The experiments were performed twice, using material from two different pit latrines. In the first set of experiments, Set 1, the raw material (VIP contents) was sampled from a household VIP near Tongaat, north of Durban, during a pit emptying campaign. The material collected came from the lower part of one pit. The pits were around fifteen years old thus the material used was fairly well degraded and stabilised.

2 Results: Set 1

Set 1 experiments were split into three batches: the first batch was to screen specific bottles which were expected to have higher gas production (T₆, T₈, T₁₆, T₁₈, T₃₁, T₃₃, and T₃₆), and the bottles which contained no sodium bicarbonate (T₁, T₂, T₃, T₄, and T₅). The second batch targeted the remaining bottles where high gas production was expected (T₁₅, T₁₆, T₁₇, T₂₁, T₂₂, T₂₃, T₂₄, T₂₇, T₂₈, T₂₉, T₃₀, T₃₄, T₃₅ and T₃₆). The third completed the experimental plan (T₉, T₁₀, T₁₁, T₁₂, T₁₄, T₂₀, T₂₆, and T₃₂). Nineteen and fifteen days respectively separated the first from the second set and the second from the third batch of experiments

Table AB.1: Summary of experimental plan (factorial matrix) to assess the effect of additional moisture and alkalinity on the anaerobic digestion of VIP contents. Each cell represents one experiment performed in triplicate containing substrate (15 g VIP solids) and varying amounts of additional water and alkalinity. Mass of alkalinity per bottle is concentration of the stock solution used (S_i ; $i \in [1,5]$) X the volume added. S_1 : 100 mg/l, S_2 : 200 mg/l, S_3 : 300 mg/l, S_4 : 400 mg/l, S_5 : 500 mg/l of NaHCO_3 . T_j is the treatment label ($j \in [1,36]$). Moisture contents presented are for trial 2.

		% moisture (g H ₂ O/ g sample)					
		76	82	86	88	90	91
Amount of alkalinity added (mg NaHCO ₃ / g dried solid)	0	76% H ₂ O 0 ml S ₁ (T ₁)	82% H ₂ O 5 ml S ₁ (T ₂)	86% H ₂ O 5 ml S ₁ (T ₃)	88% H ₂ O 5 ml S ₁ (T ₄)	90% H ₂ O 5 ml S ₁ (T ₅)	91% H ₂ O 5 ml S ₁ (T ₆)
	1.8		82% H ₂ O 5 ml S ₂ (T ₈)	86% H ₂ O 5 ml S ₂ (T ₉)	88% H ₂ O 5 ml S ₂ (T ₁₀)	90% H ₂ O 5 ml S ₂ (T ₁₁)	91% H ₂ O 5 ml S ₂ (T ₁₂)
	3.6		82% H ₂ O 5 ml S ₃ (T ₁₄)	86% H ₂ O 5 ml S ₃ (T ₁₅)	88% H ₂ O 5 ml S ₃ (T ₁₆)	90% H ₂ O 5 ml S ₃ (T ₁₇)	91% H ₂ O 5 ml S ₃ (T ₁₈)
	5.4		82% H ₂ O 5 ml S ₄ (T ₂₀)	86% H ₂ O 5 ml S ₄ (T ₂₁)	88% H ₂ O 5 ml S ₄ (T ₂₂)	90% H ₂ O 5 ml S ₄ (T ₂₃)	91% H ₂ O 5 ml S ₄ (T ₂₄)
	7.2		82% H ₂ O 5 ml S ₅ (T ₂₆)	86% H ₂ O 5 ml S ₅ (T ₂₇)	88% H ₂ O 5 ml S ₅ (T ₂₈)	90% H ₂ O 5 ml S ₅ (T ₂₉)	91% H ₂ O 5 ml S ₅ (T ₃₀)
	9.0		82% H ₂ O 5 ml S ₆ (T ₃₂)	86% H ₂ O 5 ml S ₆ (T ₃₃)	88% H ₂ O 5 ml S ₆ (T ₃₄)	90% H ₂ O 5 ml S ₆ (T ₃₅)	91% H ₂ O 5 ml S ₆ (T ₃₆)

2.1 Chemical characteristics of VIP contents: Set 1

The VIP contents were analysed for chemical characteristics before the commencement of the experiment, and the results are presented in Table AB.2.

Table AB.2: Summary of VIP contents characteristics for Set 1. VIP contents were obtained from a household VIP near Tongaat, and appeared to be fairly well stabilised before commencement of the experiment.

Parameter	Value	Units
Total solids	0.195 ± 0.005	g/g
Organic solids	0.64 ± 0.02	g/g
Inorganic solids	0.36 ± 0.02	g/g
Total COD (COD _T)	0.19 ± 0.07	g O ₂ /g sample
Soluble COD (COD _{0.45})	0.04 ± 0.01	g O ₂ /g sample
Alkalinity	13.75 ± 0.72	mg CaCO ₃ /g sample

2.2 Gas production from each experimental batch: Set 1

This section presents the data and preliminary analysis of gas production results from Set 1.

The gas production expected with the raw material used in Set 1 was around 0.21 l methane (at STP) / bottle. If methane is expected to make up roughly 50% of the gas produced by anaerobic digestion, a gas production of 0.42 l gas (at STP) / bottle was expected.

Due to slight variations in the experiment temperature and its subsequent effect on the interpretation of gas volume measurements, all the gas production results were normalised to ml gas at STP/g COD. Thus measurements from different experiments and from different sets may be directly compared.

Figure AB.1 presents the results from the first batch of bottles prepared for Set 1. Experiments in this batch were those which were expected to have higher gas production (T_6 , T_8 , T_{16} , T_{18} , T_{31} , T_{33} , and T_{36}), and the bottles which contained no sodium bicarbonate (T_1 , T_2 , T_3 , T_4 , and T_5)

After 10 days, it appeared that the serum bottles with lower amounts of water added produced greater quantities of gas. Bottles T_1 , T_2 and T_3 , containing 0, 5 and 10 ml of water respectively produced gas volumes between 1.21 and 2.37 ml/g COD whereas bottles T_4 , T_5 and T_6 containing 15, 20 and 25 ml of water respectively produced gas volumes between 0.29 and 0.49 ml/g COD. The same behaviour was observed in the bottles T_8 , T_{16} , T_{18} , T_{33} and T_{36} .

The addition of small quantities of sodium bicarbonate seemed to improve the gas production rate. A comparison of the gas production in bottles T_2 and T_8 which both had the same volume of water added but different quantities of NaHCO_3 , showed that the gas production in bottle T_8 is 1.6 times higher than for the bottle T_2 (after 10 d). However, it appears that the addition of large quantities of NaHCO_3 does not produce a significant improvement in the rate of gas production (as observed by comparing bottles T_{16} , T_{33} , and T_{18} , T_{36} compared to bottles T_4 , T_3 and T_6).

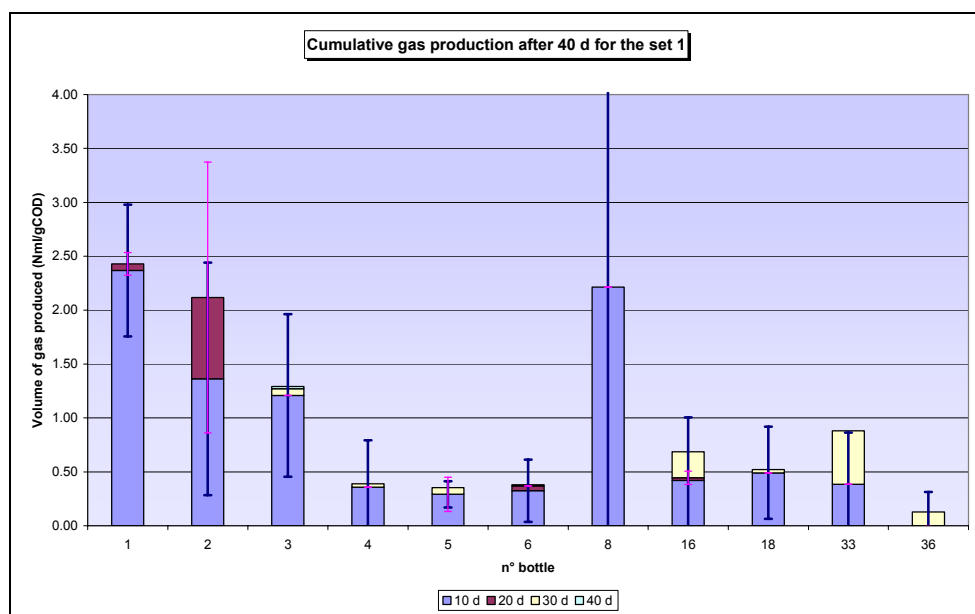

Figure AB.1: Cumulative gas production during the first batch of experiments, Set 1. (i.e. selected experiments with high expected gas production and experiments with no additional alkalinity). Error bars represent the standard deviation for each experiment calculated from the three replicates of the experiment.

After 20 days, no or only a low gas production was measured with the exception of bottle T_2 . A high gas production was recorded after 10 days whereas later, no or only a low gas production was recorded. After 30

days, some bottles (T_3 , T_4 , T_5 , T_{16} , T_{18} , T_{33} and T_{36}) produced small amounts of gas despite little or no gas production being observed after 20 days. No further gas production was measured after 40 days or at all in the following 2 ½ months in any bottles in this batch.

Standard deviations were calculated from each experiment from the three replicates of that experiment and were found to be large relative to the absolute value of gas production. Since the standard deviation is of the same order as the average gas production, (for example in bottles T_2 and T_8) no firm conclusions can be drawn about the cause of the variations observed.

Batch 2, Set 1 were the remaining bottles from Set 1 where high gas production was expected (T_{15} , T_{16} , T_{17} , T_{21} , T_{22} , T_{23} , T_{24} , T_{27} , T_{28} , T_{29} , T_{30} , T_{34} , T_{35} and T_{36}). The cumulative gas production results from this batch are presented in Figure AB.2.

After 10 days all the bottles produced gas but at different levels (from 0.06 mℓ/g COD for the bottle T_{24} to 2.06 mℓ/g COD for the bottle T_{27}). The highest gas productions were observed for a volume of water added of 10 ml with the bottles T_{15} , T_{21} and T_{27} . By symmetry the lowest gas volumes were produced at the highest water volume added (bottles T_{24} and T_{30}). Between these two extreme behaviours, no real trend can be observed. No conclusion can also be made regarding the quantities of NaHCO_3 introduced.

The gas production rate between the days 10 and 20 was the highest. Thereafter the rate of gas production decreased. After 40 days, gas production was still observed. The standard deviations were similar for all the bottles in this set, thus the results are reproducible probably due to the fact that the raw material was homogeneous for this set.

Batch 3, Set 1 contained all the remaining experiments from Set 1. These were the experiments that were expected to have a lower gas production rate than those from Batch 1 and 2 (Set 1) as a result of the lower moisture and alkalinity content. Figure AB.3 presents the cumulative gas production data for these experiments

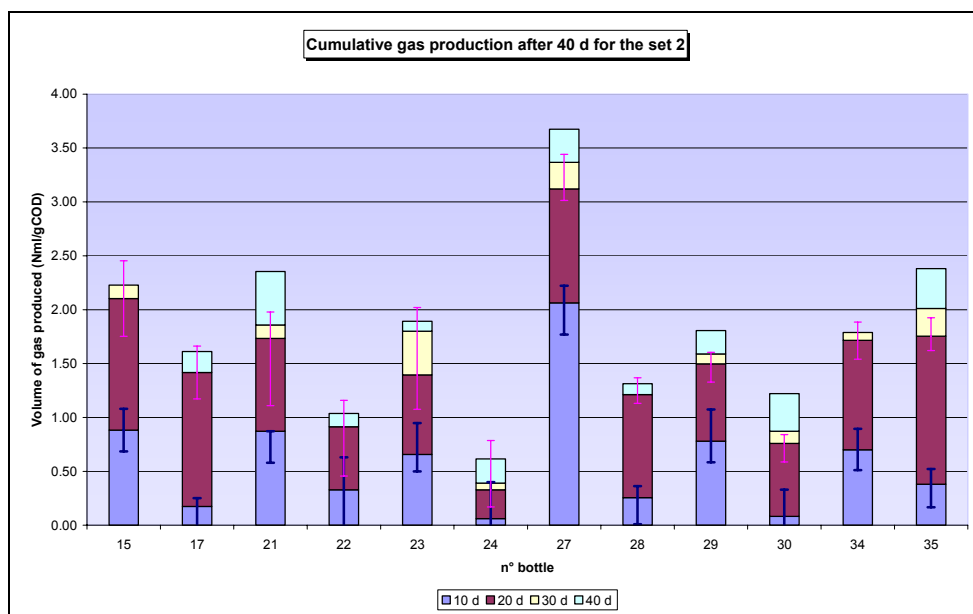

Figure AB.2: Cumulative gas production during the second batch of experiments, Set 1 (i.e. remaining experiments with high expected gas production). Error bars represent the standard deviation for each experiment calculated from the three replicates of the experiment.

After 10 days, almost no gas production was observed in any of the bottles. Only the bottles T_{14} , T_{26} and T_{32} produced gas, but not in large amounts (from 0.13 to 0.59 mℓ/g COD). These bottles had a low volume of water added (5 ml of water). However in contrast to batch 1 and 2, it appeared that a high quantity of

NaHCO₃ improved the rate of gas production (bottle T₃₂ has a production 4.5 times higher than the bottles T₁₄ and T₂₆). These two trends (positive effect of low volume of water added and high amount of NaHCO₃ introduced) were observed throughout this batch.

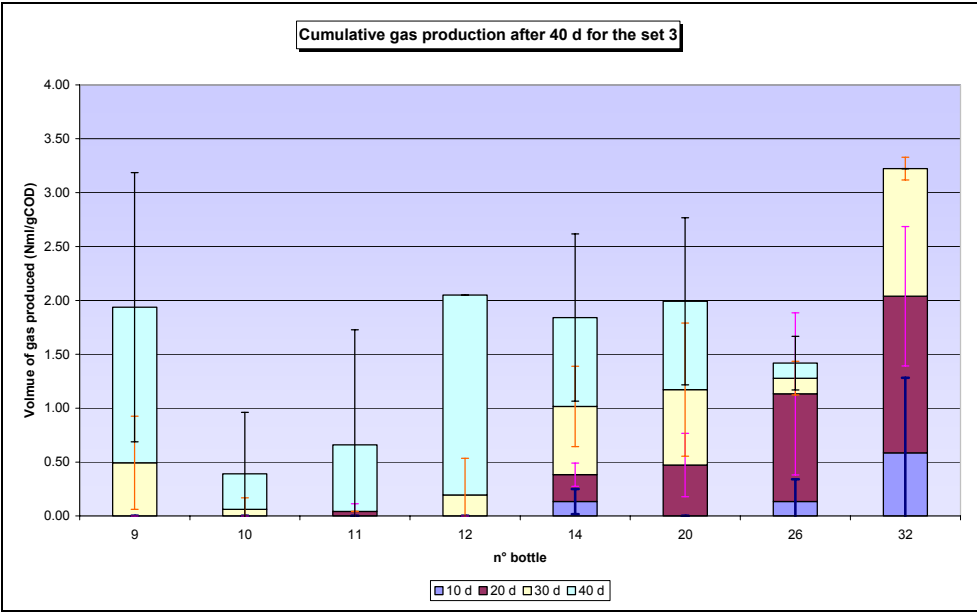

Figure AB.3: Cumulative gas production during the third batch of experiments, Set 1 (i.e. experiments with low expected gas production). Error bars represent the standard deviation for each experiment calculated from the three replicates of the experiment.

The highest gas production rate occurred after 20 days for the bottles T₁₄, T₂₀, T₂₆ and T₃₂ while the other bottles (T₉, T₁₀, T₁₁ and T₁₂) started producing gas only after 20 to 30 days and in small amounts (from 0.04 to 0.49 ml/g COD). This delay is quite large compared to the other sets.

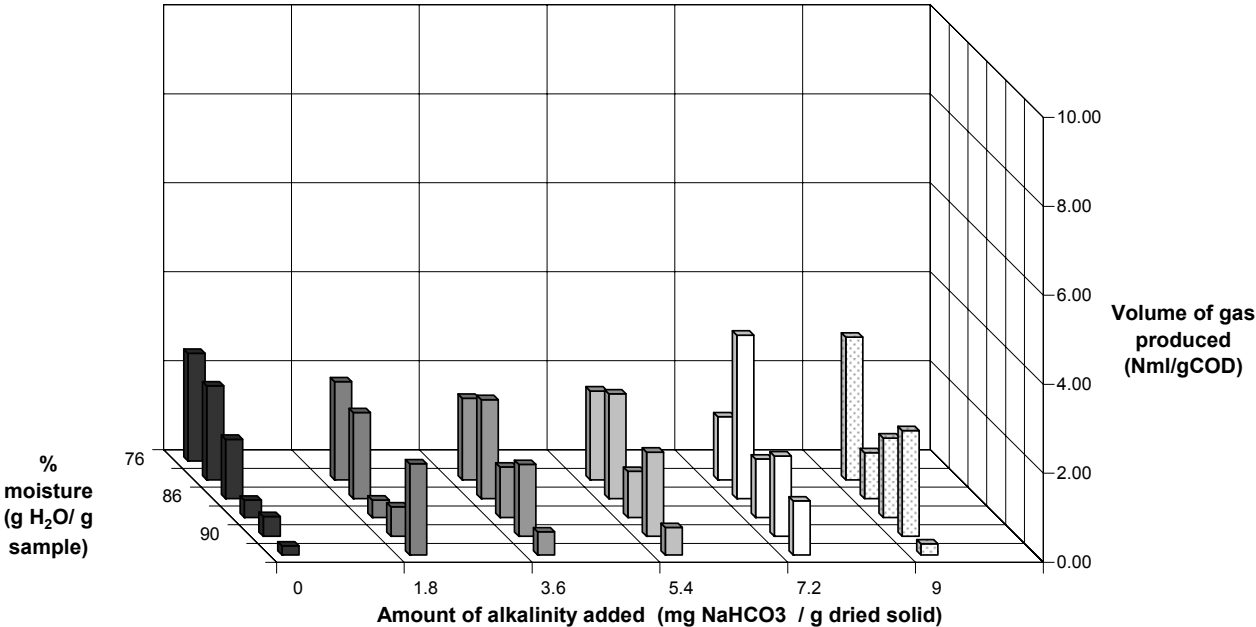

Figure AB.4: Combined results of cumulative gas production after 40 days for Batches 1, 2 and 3 from Set 1

The standard deviations in this batch are high, thereby limiting the conclusions that can be drawn from the results.

Figure AB.4 presents all cumulative gas production data from batches 1, 2 and 3 from Set 1.

2.3 Overall analysis of Set 1 experiments

In this section, the results of batches 1, 2 and 3 are combined and analysed to see if there are any general trends that may be observed.

2.3.1 General observations

Experiment 16 was performed twice, in batch 1 and batch 2. The gas production results for experiment 16 from both batches are presented in Figure AB.5. Theoretically these should have been true replicates with statistically similar results. However, it can be seen that the results from the same experiment performed in the two batches are significantly different. This result implies either that experimental error within the experiments is greater than any differences that may be caused by the addition of moisture or alkalinity, or that there is a correlation between batch number and gas production.

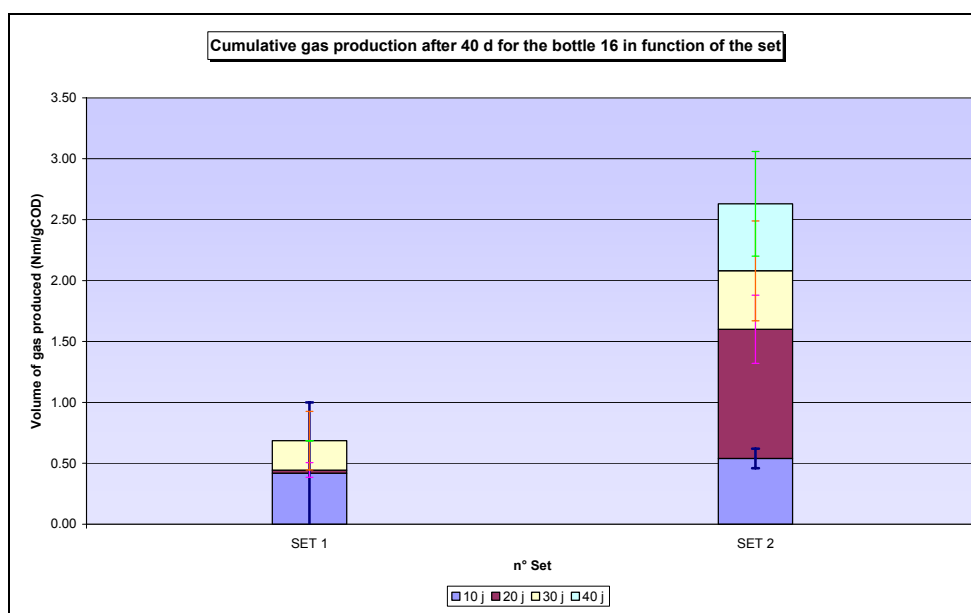

Figure AB.5: Gas production from experiment T₁₆ from batch 1 and 2

It must be noted that although a single source of material was used for all experiments in this set, the total mass of material required was around 2 kg of pit latrine contents, and clearly there will always be substantial heterogeneity in such a large sample of predominantly faecal material. This may be the cause of the significantly different behaviour observed in each of the tests.

Examination of Figure AB.4 indicates an apparent negative correlation between moisture content and gas production, while there might be some positive relationship between additional alkalinity and gas production. However as seen in Figure AB.1 to Figure AB.3 most measurements of gas production exhibit high standard deviation. Furthermore, the amount of gas produced per experiment, generally less than 3 m^l per bottle over 40 days is substantially less than the maximum possible gas production (420 m^l/bottle, see beginning of Section 2.2). Thus it was concluded that the poor gas production observed may have been due to the fact that the sample used was fairly well degraded before the beginning of the experiments and hence that there was only a limited amount of degradation that could occur in the experiments. This implies that the experiment was fundamentally flawed and that the hypotheses to be tested (viz. additional alkalinity and

moisture have a beneficial effect on the rate of degradation under anaerobic conditions) were irrelevant under the test conditions

2.3.2 Statistical analyses

Two types of statistical test were performed on the data for experimental set 1: firstly the means for each experiment were tested for significant differences from the control. Secondly, a two factor analysis was performed to investigate the effect of the factors moisture and alkalinity on the gas production from the experiments.

Comparing treatments with a control: C.W. Dunnett has developed a test for determining if the difference between each treatment mean and a control is significant at a significance level α . In this study, bottle T₁ was the control, and 30 different treatments replicated 3 times were tested to determine whether the mean value of gas production for these tests was significantly different to the control. A two-tailed test was used because even if a significantly larger gas production than that of the control is expected; it is also interesting to see if the treatment does not produce the opposite effect. The conclusion from this test was that the treatments do not significantly affect (at a level $\alpha = 0.05$) the gas production relative to the control. However, it can be noted that the effect of the treatments is mainly negative compared to the control.

The effects of addition of additional inoculum (anaerobic sludge) or NMS on the gas production were also tested with this test of significance. It appears that there is no *significant* difference between the control and experiments with additional inoculum or NMS, although the overall gas production on these units was generally slightly higher than the control.

Two-factor analysis: two factors (moisture and alkalinity) were investigated in terms of their effect on gas production in the experiment. The conclusion of this test is that there is no interaction between the two factors but they both affect the biodegradation rate.

If the conclusions of the tests are combined, it implies that the treatments did not have a significant effect on the gas production rate, but that there was an observable effect that seemed to be negative (i.e. treatments resulted in a decrease in gas production).

2.4 Investigation into negative impact of moisture content on gas production

Considering experiments T₁, T₂, T₃, T₄, T₅ and T₆ (i.e. experiments with increasing moisture content, but no additional alkalinity) it appears that the addition of moisture to the experiments reduces the amount of gas produced. This is in direct contrast to the expectation that improved mass transfer conditions would result in improved degradation rates and therefore increased gas production. It was hypothesised that the reduced gas production could be due to increased absorption of produced CO₂ in experiments with additional moisture. In other words, if each of these 6 experiments exhibited roughly the same rate of degradation, and therefore the same number of molecules of CO₂ and CH₄ gas were produced, the amount of CO₂ retained as a dissolved species in the liquid phase increased with increasing moisture content, resulting in a decreased net gas production rate from the experiment.

In order to test whether this hypothesis could explain the observed phenomena, simulations of CO₂ absorption were performed using PHREEQ (aquatic chemical speciation software distributed by US Geological survey). The simulated experiment composition was defined as the NaHCO₃ quantities added into the water. The gas phase was specified by the flushing gas (N₂/CO₂, 50/50). Simulations were done by using these specifications at constant volume (closed system) and at a temperature of 37°C (experimental temperature). Other sets of simulations modelled the effect of the increase of pressure, and in particular the increase of CO₂ linked to the biogas production during the biodegradation. From all these trials, it appears that the greater the volumes of water present in each experiment, the more gas is absorbed. This phenomenon explains the trends observed in the experiments. As CO₂ is produced by biological activity, a

portion remains dissolved in the liquid phase until equilibrium is reached between the dissolved CO₂ in the liquid phase and the headspace gas CO₂ composition.

A corollary of this result is that if significant CO₂ absorption occurs, the fraction of CH₄ in the gas phase should be equivalently larger. Incomplete gas composition data was obtained, and generally the variability observed even between replicates prevents quantitative predictions for CO₂ absorption; however it was observed experimentally that even when no gas production was recorded it was possible to detect methane by analysing the gas from the headspace with the GC. The combination of these calculations and observations support the hypothesis that the decreased gas production observed for increasing moisture content in the absence of additional NaHCO₃ in the experiments was due to increased absorption of CO₂ in the moisture.

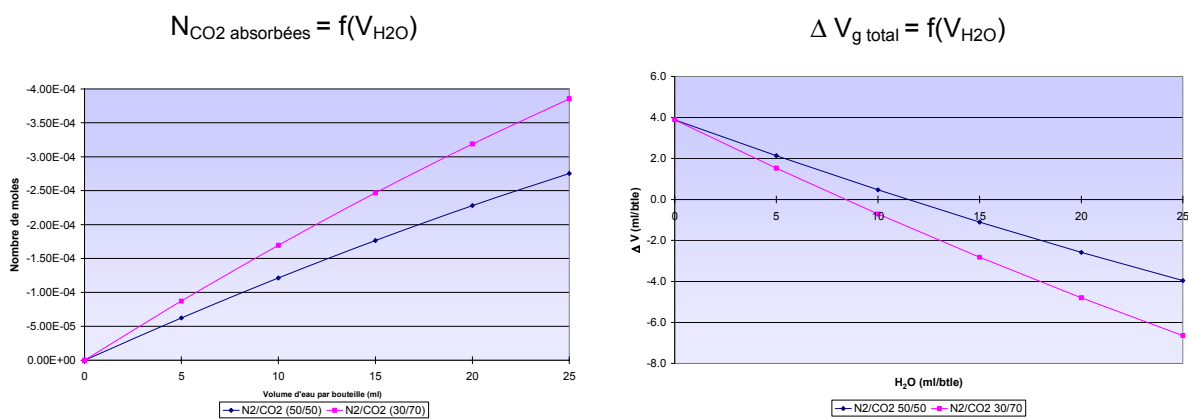

Figure AB.6: Results of PHREEQ simulations of CO₂ absorption and variation in gas production due to the absorption in moisture.

Thus it is not possible to make any conclusions about whether or not additional moisture affects the rate of degradation of pit latrine contents under anaerobic conditions.

2.5 Conclusions from Set 1 experiments

It was not possible to draw any firm conclusions about the effect of the treatments on the rate of degradation in these experiments. This was attributed to the fact that the material used in the tests was already well degraded at the beginning of the experiments and therefore that the treatments were irrelevant in the context of the experimental conditions. It was also shown that the presence of additional moisture may have a confounding effect by absorbing produced CO₂ and thereby confusing the interpretation of gas production data.

3 Results: Set 2

It was proposed that the experiment should be repeated using a newer (i.e. less well-degraded) source of material.

3.1 Characteristics of VIP contents: Set 2

The new sample was collected from a rural school outside Pietermaritzburg. This new material comes from the top layer of a pit thus it was not well-degraded. The colour of this new material was brown whereas the old one was black. All the experiments for Set 2 were prepared at the same time and the sample was mixed (as well as it is possible to do so) before filling of the bottles.

Complete chemical characterisation of this material was not performed due to time constraints. However moisture content was determined and found to be 76%.

3.2 Gas production from each experimental batch: Set 1

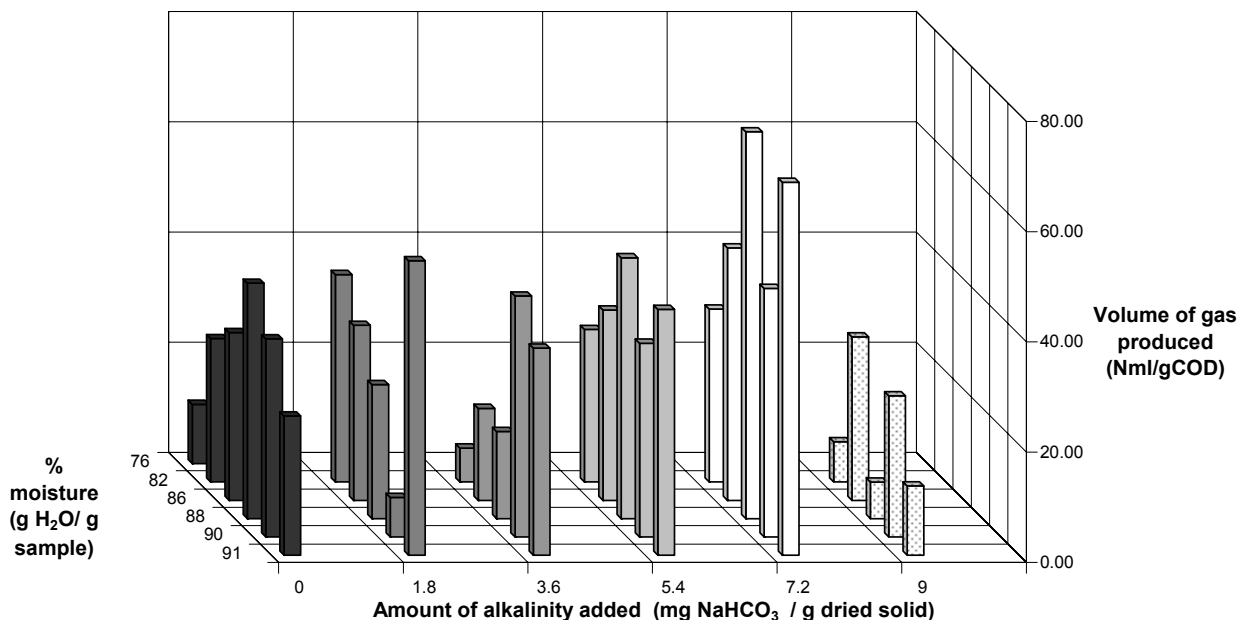

Figure AB.7: Cumulative gas production results after 36 days for experiment Set 2 showing dependence of gas production on additional moisture and alkalinity.

Figure AB.7 presents cumulative gas production after 36 days in matrix form to show the effect of increasing moisture and alkalinity on gas production. Note that the scale on the vertical axis of Figure AB.7 is much larger than that of Figure AB.4 due to the much higher gas production rates. Figure AB.7 shows that the control bottles (i.e. no moisture or alkalinity added) produced virtually no gas. In contrast, all other experimental bottles produced significant amounts of gas. Clearly, according to these results, the addition of water had a significant effect on the gas production rate.

The data from Set 2 did not support the hypothesis that the addition of alkalinity had any effect on the gas production rate (either positive or negative). However, regression analysis showed that there was a significant relationship between the rate of gas production and the moisture content²³. However, only 10% of the variation observed in the data can be explained by the moisture content ($R^2 = 0.097$); i.e. 90% was due to unmeasured factors such as the variation in biodegradability of the pit latrine contents due to its non-homogeneous nature. The regression predicted that the rate of gas production increased by a rate of between 0.006 and 0.02 ml gas/g total solids/day per 1% increase in moisture content.

²³ Significance of regression = 0.002 < 0.05 therefore it is a 95% probability that increased moisture content causes an increase in gas production

4 Conclusions from Set 1 and Set 2 experiments

The purpose of these experiments was to determine whether addition of moisture and/or NaHCO₃ to samples of fresh VIP contents had a statistically significant effect on gas production rate under anaerobic conditions. The gas production rate was understood to be correlated to the rate of anaerobic degradation of the VIP contents, and an enhanced gas production rate would thus be an indication of improved stabilisation rates. Experiments from Set 2 showed that VIP contents alone (with no additional water or NaHCO₃) had negligible gas production across three replicates; however, addition of water only or water and NaHCO₃ resulted in statistically significant increases in gas production. It was not possible to determine whether the addition of NaHCO₃ had any effect on gas production rate (either positive or negative)

It was also observed that increasing the amount of water at the beginning of the experiment could have the opposite effect, i.e. reduced gas production rates as a result of absorption of CO₂ in the moisture (See Appendix B for details). However, after a certain amount of time, CO₂ absorption ceased as the inorganic carbon content in the aqueous phase approached saturation with respect to the headspace of the experiment.²⁴ Thereafter, the gas production rate (as opposed to the cumulative amount of gas produced) was greater for experiments with more added water than those with less.

The conclusion of this work was that increasing moisture content of VIP contents has the potential to increase the rate of stabilisation of buried organic material in the pit.

Significantly greater amounts of gas were produced per test unit for Set 2 units relative to Set 1 units. This supports the hypothesis that the generally poor performance of all treatments in Set 1 was less a function of the treatments than that the VIP contents used were already well digested and therefore inherently resistant to further degradation.

This study supports the motivating hypothesis that the moisture content generally observed in VIP material is low and may be a limiting factor in the rate of anaerobic digestion that may occur in the buried pit contents. This implies that increasing the moisture content in the pit has the potential to increase stabilisation rates in the pit. These broad findings are supported by literature which state that the rate of accumulation in pits is lower in *wet* pits than in *dry* pits (Franceys et al., 1992).

This study indicated that addition of NaHCO₃ resulted in no significant effect on gas production rate, thereby refuting the hypothesis that there is insufficient buffering capacity in pit latrine contents to support stable anaerobic digestion. This could be explained in the context of the general theory of processes in pit latrines (Section 3.1) in that if a significant proportion of the biological conversion of organic material in the pit latrine happens aerobically on the surface of the pit three effects would reduce the pH buffering requirement in pit latrine contents:

- The buffering capacity requirement for aerobic degradation is less than for anaerobic digestion since there is no accumulation of acid intermediates in aerobic degradation.
- There will be a smaller load of organic material requiring anaerobic digestion, and thus a smaller overall buffering requirement (than if the entire load of organic material entering the pit were considered)
- The process of aerobic degradation will increase the overall alkalinity of the contents of the pit latrines

²⁴ This is a somewhat simplistic explanation since the "equilibrium" in each experiment will be dynamic: it will depend on pH, headspace gas composition and pressure, relative rate of production of CO₂ and CH₄, frequency of headspace venting and aqueous phase concentrations of a range of chemical species.

Finally, it may also be concluded that there is no significant benefit to adding water or alkalinity to pits wherein the material is already well-stabilised.

APPENDIX C: LIST OF COMMERCIAL PIT LATRINE ADDITIVE SUPPLIERS

Trade name:	Toilet Muthi
Supplier:	CAM Trading
Email address:	tmunro@erp.co.za
Trade name:	Toilet Smart
Supplier:	Eco-Sol
Telephone ; Fax:	(031) 709 3414 ; (031) 709 4266
Email address:	sean@yonkesolutions.co.za ; admin@yonkesolutions.co.za
Trade name:	GES-WT1000, GES-WTa
Supplier:	PD & M Services
Telephone ; Cell:	(011) 425 1459 ; 082 363 0002
Email address:	pd-mservices@metroweb.co.za
Trade name:	Pit King ; Fat King
Supplier:	AVANTU
Telephones:	(011) 803 1361 ; 082 922 1973
Email address:	avantu@mweb.co.za ; peterw@isogo.co.za
Web address:	www.avantu.com
Trade name:	Sannitree
Supplier:	Sannitree International
Telephones; Fax:	(021) 701 1266 ; (021) 701 1299
Email address; Web address:	sannibg@mweb.co.za ; www.sannitree.co.za
Trade name:	Bi-Chem SM 700
Supplier:	Novozymes Biologicals, Inc
Telephones; Fax:	(0944) 540-302-1139 ; (0944) 540-389-2688
Email address; Web address:	MLiv@novozymes.com
Trade name:	Bohlisa
Supplier:	Cyberchem
Telephones; Fax ; Cell:	(031) 764 1968; 086 6534274 ; 082 8050858
Email address; Web address:	chris@tailormade.co.za
Trade name:	MONKO
Supplier:	CRYSTAL CLEAR Consulting & Merchants Pty Ltd
Telephones; Fax ; Cell:	(011) 882 3368 ; (011) 882 3395 ; 082 4444 296
Email address:	milton@crystalclear.co.za
Trade name:	PLR (Pit latrine reviver/SK3)
Supplier:	Biosystems SA
Telephones/Fax ; Cell:	(021) 786 2972 ; 082 901 9011
Email address; Web address:	bob@biosystemssa.co.za ; www.biosystemssa.co.za

APPENDIX D: PROTOCOL FOR TESTING PIT LATRINE ADDITIVES

This appendix outlines the methods developed for testing pit latrine additives. Possible mechanisms by which pit latrine additives could affect the mass or volume of the contents of pit latrines are identified. Detailed methodology for undertaking the tests is presented.

1 Pit latrine content samples

Pit latrine additive tests were performed on samples that were representative of the material that the additives would be expected to act on, i.e. the top layer of material in a pit latrine. However, previous research has indicated that the composition of pit latrine contents varies considerably and furthermore has been found to contain inhibitory substances added to the pit by the owner; hence additive tests should be replicated on pit latrine material sampled from the top layer (to a depth not exceeding 100 mm) from at least two different pit latrines.

2 Sampling and storage of pit latrine content samples

Pit latrine content samples were withdrawn from the pits via the pit backplate using shovels for drier material and buckets for wetter material. Samples were loaded into buckets or jars and sealed to limit exposure to air. (Availability of air assists in biologically mediated oxidation and stabilisation of pit latrine materials; eliminating air as far as possible ensured that the pit latrine samples used in additive trials were not substantially different to the material in the pit.) Sample buckets / bottles were tied into plastic bin bags and transported in closed plastic storage boxes to ensure three levels of containment. Once in the laboratory, samples were thoroughly mixed in an effort to obtain a certain amount of homogeneity between treatments and replicates. Thereafter, a mass of approximately 300 g per jar was added into honey jars, or if trials were not to begin immediately, samples were stored sealed in a cold-room at 4 °C.

3 Analyses of pit latrine content samples

Although the focus of these tests was to determine the efficacy of pit latrine additives for reducing mass and volume it was necessary to obtain a characterisation of the pit latrine material before and after each test to provide back-up information to determine the underlying cause of test observations. Pit latrine content characterisations also provided information that allowed comparison between results from tests using different pit latrine material.

Chemical oxygen demand (COD), total solids (TS) and organic solids (OS) analyses were performed in triplicate on whole pit latrine content samples according to Standard Methods (APHA, 1998). A rough measure of pH was obtained using litmus paper.

These measurements were used to calculate total sample COD, moisture content, organic solids content and inorganic solids content. All values were calculated on a per g total solids basis to eliminate variations in concentration with time that were due to changes in moisture content. The inorganic solids load of a fixed package of pit latrine material is expected to stay constant over the life of that package of material, i.e. inorganic solids content does not degrade, and should not be transported away from the original package to any great extent. Thus it was reasonable to use 1 g of inorganic solids as a unit for comparison between different samples. However, inorganic solids measurements had a large variance and thus amounts

calculated on a per g inorganic solids basis tended to have high uncertainty. Therefore values of COD were reported on a per g dry solids basis.

4 Honey-jar trials

The principle of these tests was to quantify mass effects of treatment with pit latrine additives on pit latrine samples without any complicating effects from liquid transport, addition or dehydration.

4.1 Materials and methods

The test units consisted of 300 ml plastic jars with screw tops. Approximately 200 g of pit latrine contents was added to each jar and pressed down with a spatula to flatten the surface. The mass of the bottle before and after filling was measured to quantify the mass of pit latrine content. A graduated metal skewer was inserted into the jar in 4 places to measure the height of material in the jar. (After taking this measurement, the surface was smoothed to eliminate the holes made by the skewer). Where necessary, pit latrine additives were made up with water according to manufacturer's instructions and dosed to the test units on a per area basis according to equation AD-1.

$$\text{dose [ml]} = \frac{\text{recommended dose [ml]} \cdot \text{surface area of honey jar [m}^2\text{]}}{\text{surface area of pit latrine [m}^2\text{]}} \quad \text{equation AD-1}$$

For anaerobic units, lids were screwed tightly to the honey jars, while aerobic units were left open.

For each trial, a number of treatments were investigated.

- Control: Units containing only pit latrine sample acted as controls so that uncontrolled effects such as natural degradation and dehydration could be quantified.
- Water treatment: Water was added to these units to quantify the effects of dilution, suspension and water transport on the trials in the absence of other chemical and biological additives
- Commercial additive treatments: Additives sourced from suppliers and manufacturers were added to test units on a per area basis, i.e. assuming a real pit has a surface area of approximately 1 m² (a conservative estimate¹) the amount of additive that the recommended supplier's dosage would provide per unit surface area of the pit was scaled to give the same dose per unit surface area of the experimental "pit".

Three to five replicates were prepared for each treatment.

All units were carefully weighed and loaded into storage boxes and placed in fume cupboards. The fume cupboard extractor fans were turned on in order to remove the risk of exposure of laboratory personnel to aerosolisation of pathogens. The storage boxes were closed with lids so that they were not exposed to the draught caused by the extractor fans, but holes were drilled into the sides of the boxes so that air could diffuse in for the aerated units. An open jar containing water was also added to each box to increase the humidity within the box and thereby reduce effect of evaporation on mass and height of contents in each unit.

Each unit was weighed on an analytical balance on a daily basis for two or more weeks. At the end of the test period, the units were weighed again and the height of contents was measured in four places with the graduated metal skewer.

¹ This means that the additive dosage may have been generous compared to what would be received in a pit latrine, and thus there should have been no negative effect on amount of additive used from downsizing the experiment from full-scale to honey-jar scale.

4.2 Chemical analyses

In addition to mass and height of sample, the measurements of COD, total and organic solids were performed according to Section 3.

4.3 Analyses of results

Mass data was plotted against time to observe the rate of change of mass per unit. It was found that the shape of the mass loss curves was not significantly different to a straight line in all units tested. Mass loss per unit at time t was calculated by the difference between the starting mass ($M_{i,0}$) of each unit i and its mass at time t ($M_{i,t}$) (equation AD-2).

$$\Delta M_{i,t} = M_{i,0} - M_{i,t} \quad \text{equation AD-2}$$

The rate of mass loss was calculated as the least squares regression line through the mass loss data – time plot for each unit i and expressed in terms of kg mass lost per m^2 surface area per day. The variance of the rate of mass loss was calculated as the variance of the slope of the regressed line.

The combined slopes of each of the treatments were compared to the combined slopes of the control tests using a combined variance for each treatment and subjecting the data to a Welch¹ test. This provides a sound basis for saying whether or not a treatment results in an increase in mass loss rate.

¹ The Welch test tests the hypothesis that a sample of data points is significantly different to an independent set of data points, where the variances of the data points used are unequal.

APPENDIX E: CAPACITY BUILDING

In total, 16²⁷ students have been involved in this project, of which 4 are black, 7 are Indian, and 5 are white. 10 are female. Of the 16 students, 10 are South Africans, 2 are from other African countries, and 4 are non-African.

Three MSc (Eng) degrees (Politecnico di Milano, Italy; Université Paul Cézanne, France) and two BSc Honours degree have been awarded for research on this project. One MSc dissertation and one MSc (Eng) dissertation are still to be submitted. The three MSc Eng degrees were awarded to students from institutions other than UKZN, where the research component has been undertaken in conjunction with this project. A further three undergraduate research projects in the School of Biological and Conservation Sciences at UKZN have also been satisfactorily completed.

Table E.1: Students and assistant researchers involved in K5/1630

Category	Personnel	Year	Race	Gender	Nationality
Post graduate students (UKZN)	Ms C Nwaneri (MSc student)	2006, 2007	B	F	African
	Mrs A Bindoff (MSc(Eng) student)	2006, 2007	W	F	S African
	Mr B Bakare (PhD student)	2007	B	M	African
Post graduate students (Other)	Mr D Magagna (MSc (Eng) student, Politecnico di Milano)	2006	W	M	Non-African
	Ms E Balboni (MSc (Eng) student, Politecnico di Milano))	2006	W	F	Non-African
	Ms A Couderc (MSc (Eng) student, Université P. Cézanne)	2007	W	F	Non-African
Undergraduate students (UKZN)	S Mkhize (3 rd year biological sciences, BSc Hons)	2005, 2006, 2007	B	M	S African
	Ms S Naidoo (BSc Hons biological sciences)	2005	B	F	S African
	Ms N Pillay (3 rd year biological sciences)	2005	I	F	S African
	Mr P Khubheka (3 rd year biological sciences)	2005	I	M	S African
	Ms Firdaus Khan (3 rd year biological sciences)	2005	I	F	S African
	Ms Fathima Khan (3 rd year biological sciences)	2005	I	F	S African
Research assistants	Ms N Pillay	2006	I	F	S African
	Mr M Guiness	2005, 2006	I	M	S African
	Ms S Ali	2007	I	F	S African
	Mr T Naidoo	2007	I	M	S African
	Ms L Koepp	2007	W	F	Non-African

²⁷ One student (Ms N Pillay) appears as both an undergraduate student and a research assistant.